

NI8U-M12-AN6X-H1141

Inductive sensor

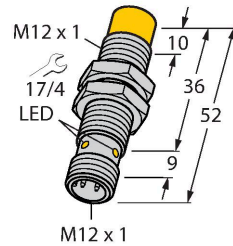

Features

- M12 × 1 threaded barrel
- Chrome-plated brass
- Factor 1 for all metals
- Protection class IP68
- Resistant to magnetic fields
- Extended temperature range
- High switching frequency
- DC 3-wire, 10...30 VDC
- NO contact, NPN output
- M12 × 1 male connector

Wiring diagram

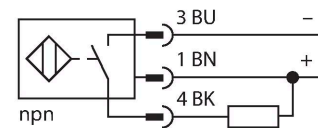

Functional principle

Inductive sensors detect metal objects contactless and wear-free. *uprox*® Factor 1 sensors have significant advantages due to their patented ferrite-coreless multicoil system. They detect all metals at the same large switching distance and are resistant to magnetic fields.

Technical data

| | |
|---|---|
| Type | NI8U-M12-AN6X-H1141 |
| Ident. no. | 1644150 |
| Rated switching distance | 8 mm |
| Mounting conditions | Non-flush |
| Secured operating distance | $\leq (0.81 \times S_n)$ mm |
| Repeat accuracy | $\leq 2\%$ of full scale |
| Temperature drift | $\leq \pm 10\%$ |
| | $\leq \pm 15\%$, $\leq -25\text{ °C}$ v $\geq +70\text{ °C}$ |
| Hysteresis | 3...15 % |
| Ambient temperature | -30...+85 °C |
| Operating voltage | 10...30 VDC |
| Residual ripple | $\leq 10\% U_s$ |
| DC rated operational current | $\leq 200\text{ mA}$ |
| No-load current | $\leq 20\text{ mA}$ |
| Residual current | $\leq 0.1\text{ mA}$ |
| Isolation test voltage | $\leq 0.5\text{ kV}$ |
| Short-circuit protection | yes / Cyclic |
| Voltage drop at I_e | $\leq 1.8\text{ V}$ |
| Wire breakage/Reverse polarity protection | yes / Complete |
| Output function | 3-wire, NO contact, NPN |
| Insulation class | □ |
| Switching frequency | 2 kHz |
| Design | Threaded barrel, M12 × 1 |
| Dimensions | 52 mm |

Technical data

| | |
|------------------------------------|---|
| Housing material | Metal, CuZn, Chrome-plated |
| Active area material | Plastic, LCP |
| Max. tightening torque housing nut | 10 Nm |
| Electrical connection | Connector, M12 × 1 |
| Vibration resistance | 55 Hz (1 mm) |
| Shock resistance | 30 g (11 ms) |
| Protection class | IP68 |
| MTTF | 874 years acc. to SN 29500 (Ed. 99) 40 °C |
| Switching state | LED, Yellow |

Mounting instructions

Mounting instructions/Description

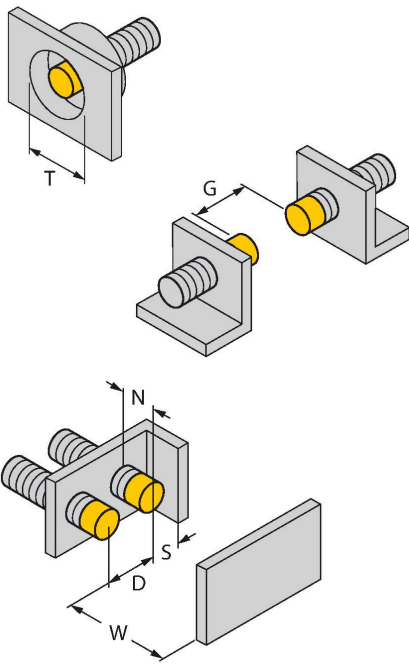

| | |
|------------------------|---------|
| Distance D | 48 mm |
| Distance W | 3 x Sn |
| Distance T | 45 mm |
| Distance S | 1.5 x B |
| Distance G | 6 x Sn |
| Distance N | 2 x Sn |
| Diameter active area B | Ø 12 mm |

Accessories

QM-12

6945101

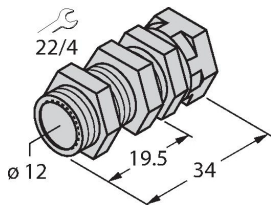

Quick-mount bracket with dead-stop; material: Chrome-plated brass. Male thread M16 × 1. Note: The switching distance of the proximity switches may change when using quick-mount brackets.

BST-12B

6947212

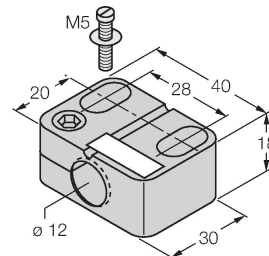

Mounting clamp for threaded barrel sensors, with dead-stop; material: PA6

MW12 6945003

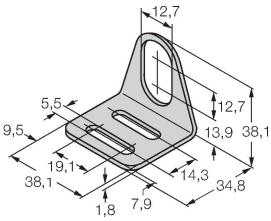

Mounting bracket for threaded barrel sensors; material: Stainless steel A2 1.4301 (AISI 304)

BSS-12 6901321

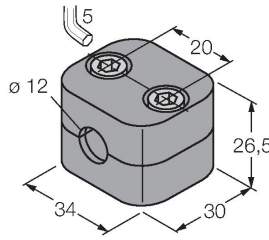

Mounting clamp for smooth and threaded barrel sensors; material: Polypropylene

Wiring accessories

Dimension drawing Type Ident. no.

RKC4T-2/TEL

6625010

Connection cable, female M12, straight, 3-pin, cable length: 2 m, sheath material: PVC, black; cULus approval; other cable lengths and qualities available, see www.turck.com





**SCATTERGOOD
& JOHNSON LTD**
ELECTRICAL ENGINEERING & FLUID CONTROL DISTRIBUTORS

Est.1899

At Scattergood & Johnson Ltd, we pride ourselves on being a technical distributor to specialist industries.

Working with a range of quality product suppliers across a number of specialist markets, we are not your average 'box shifter' - we are your technical and supply chain partner.

We fully support every product we sell - for free! Our internal team and external sales engineers can answer any product or application question, no matter the complexity.

Backing up this technical ability is a range of 50,000+ products available from stock for nationwide next day delivery (same day if required!), or you can collect what you need from any of our trade counters around the UK.

Select your specialist interest below to learn more about how we can help.



Online, In Branch and On the Road - Scattergood & Johnson Ltd, there when you need us.

www.scatts.co.uk