

# NI15U-M18-AP6X-H1141

## Inductive sensor

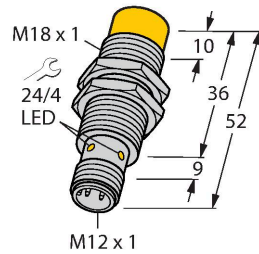

### Features

- Threaded barrel, M18 x 1
- Chrome-plated brass
- Factor 1 for all metals
- Protection class IP68
- Resistant to magnetic fields
- Large switching distance
- Integrated protection against pre-attenuation
- Little metal-free spaces
- DC 3-wire, 10...30 VDC
- NO contact, PNP output
- M12 x 1 male connector

### Wiring diagram

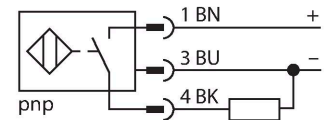

### Functional principle

Inductive sensors detect metal objects contactless and wear-free. Due to the patented multi-coil system, *uprox*<sup>®</sup>+ sensors have distinct advantages over conventional sensors. They excel in largest switching distances, maximum flexibility and operational reliability as well as efficient standardization.

### Technical data

Type	NI15U-M18-AP6X-H1141
Ident. no.	1635331
Rated switching distance	15 mm
Mounting conditions	Non-flush
Secured operating distance	$\leq (0.81 \times S_n)$ mm
Repeat accuracy	$\leq 2\%$ of full scale
Temperature drift	$\leq \pm 10\%$
	$\leq \pm 15\%$ , $\leq -25\text{ °C}$ v $\geq +70\text{ °C}$
Hysteresis	3...15 %
Ambient temperature	-30...+85 °C
Operating voltage	10...30 VDC
Residual ripple	$\leq 10\% U_s$
DC rated operational current	$\leq 200$ mA
No-load current	$\leq 20$ mA
Residual current	$\leq 0.1$ mA
Isolation test voltage	$\leq 0.5$ kV
Short-circuit protection	yes / Cyclic
Voltage drop at $I_e$	$\leq 1.8$ V
Wire breakage/Reverse polarity protection	yes / Complete
Output function	3-wire, NO contact, PNP
Insulation class	□
Switching frequency	1.5 kHz
Design	Threaded barrel, M18 x 1
Dimensions	52 mm

## Technical data

Housing material	Metal, CuZn, Chrome-plated
Active area material	Plastic, LCP
Max. tightening torque housing nut	25 Nm
Electrical connection	Connector, M12 × 1
Vibration resistance	55 Hz (1 mm)
Shock resistance	30 g (11 ms)
Protection class	IP68
MTTF	874 years acc. to SN 29500 (Ed. 99) 40 °C
Switching state	LED, Yellow

## Mounting instructions

### Mounting instructions/Description

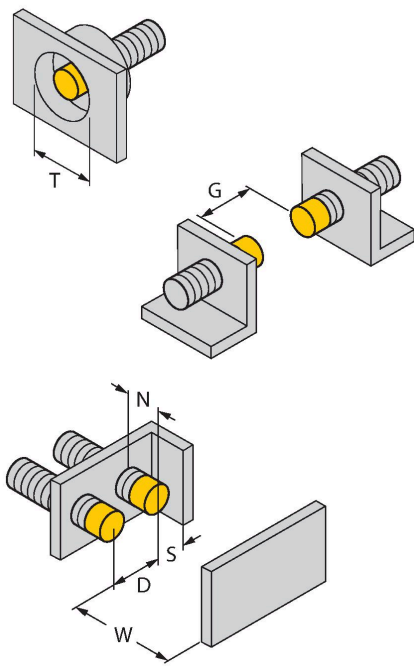

Distance D	72 mm
Distance W	3 x Sn
Distance T	3 x B
Distance S	1.5 x B
Distance G	6 x Sn
Distance N	2 x Sn
Diameter active area	Ø 18 mm
B	

All non-flush mountable *uprox*<sup>®</sup>+ threaded barrel sensors can be screwed to the upper edge of the barrel. Thus safe operation is guaranteed with a reduced switching distance of max. 20 %. When installed in an aperture plate a distance of X = 70 mm must be observed.

## Accessories

### BST-18B

6947214

Mounting clamp for threaded barrel sensors, with dead-stop; material: PA6

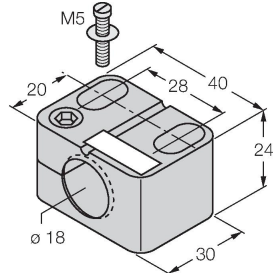

### QM-18

6945102

Quick-mount bracket with dead-stop; material: Chrome-plated brass. Male thread M24 × 1.5. Note: The switching distance of the proximity switches may change when using quick-mount brackets.

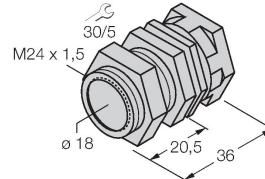

**MW18**

**6945004**

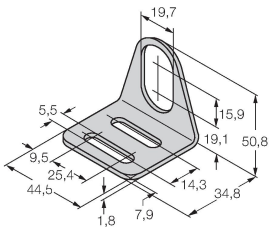

Mounting bracket for threaded barrel sensors; material: Stainless steel A2 1.4301 (AISI 304)

**BSS-18**

**6901320**

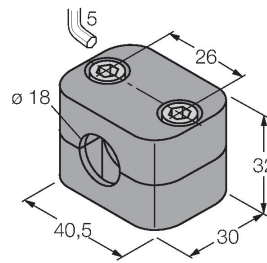

Mounting clamp for smooth and threaded barrel sensors; material: Polypropylene

Wiring accessories

**Dimension drawing**

**Type**

**Ident. no.**

**RKC4T-2/TEL**

**6625010**

Connection cable, female M12, straight, 3-pin, cable length: 2 m, sheath material: PVC, black; cULus approval; other cable lengths and qualities available, see [www.turck.com](http://www.turck.com)





# SCATTERGOOD & JOHNSON LTD

ELECTRICAL ENGINEERING & FLUID CONTROL DISTRIBUTORS

Est.1899

At Scattergood & Johnson Ltd, we pride ourselves on being a technical distributor to specialist industries.

Working with a range of quality product suppliers across a number of specialist markets, we are not your average 'box shifter' - we are your technical and supply chain partner.

We fully support every product we sell - for free! Our internal team and external sales engineers can answer any product or application question, no matter the complexity.

Backing up this technical ability is a range of 50,000+ products available from stock for nationwide next day delivery (same day if required!), or you can collect what you need from any of our trade counters around the UK.

Select your specialist interest below to learn more about how we can help.



Online, In Branch and On the Road - Scattergood & Johnson Ltd, there when you need us.

# [www.scatts.co.uk](http://www.scatts.co.uk)