

DATASHEET - DILM40(RDC240)

Contactor, 3 pole, 380 V 400 V 18.5 kW, RDC 240: 200 - 240 V DC, DC operation, Screw terminals

Part no. DILM40(RDC240)
Catalog No. 277783
Alternate Catalog No. XTCE040D00BD

Delivery program

Product range				Contactors
Application				Contactors for Motors
Subrange				Contactors up to 170 A, 3 pole
Utilization category				AC-1: Non-inductive or slightly inductive loads, resistance furnaces NAC-3: Normal AC induction motors: starting, switch off during running AC-4: Normal AC induction motors: starting, plugging, reversing, inching
Notes				Also suitable for motors with efficiency class IE3. IE3-ready devices are identified by the logo on their packaging.
Connection technique				Screw terminals
Number of poles				3 pole
Rated operational current				
AC-3				
Notes				At maximum permissible ambient temperature (open.)
380 V 400 V	I_e	A		40
AC-1				
Conventional free air thermal current, 3 pole, 50 - 60 Hz				
Open				
at 40 °C	$I_{th} = I_e$	A		60
enclosed	I_{th}	A		45
Conventional free air thermal current, 1 pole				
open	I_{th}	A		125
enclosed	I_{th}	A		112
Max. rating for three-phase motors, 50 - 60 Hz				
AC-3				
220 V 230 V	P	kW		12.5
380 V 400 V	P	kW		18.5
660 V 690 V	P	kW		23
AC-4				
220 V 230 V	P	kW		5
380 V 400 V	P	kW		9
660 V 690 V	P	kW		12
Contact sequence				
Instructions				Contacts to EN 50 012. integrated suppressor circuit in actuating electronics
Can be combined with auxiliary contact				DILM150-XHI(V).. DILM1000-XHI(V)..
Actuating voltage				RDC 240: 200 - 240 V DC
Voltage AC/DC				DC operation
Connection to SmartWire-DT				no

Technical data

General

Standards			IEC/EN 60947, VDE 0660, UL, CSA
Lifespan, mechanical			
DC operated	Operations	$\times 10^6$	10
Operating frequency, mechanical			
DC operated	Operations/h		5000
Climatic proofing			Damp heat, constant, to IEC 60068-2-78 Damp heat, cyclic, to IEC 60068-2-30
Ambient temperature			
Open	°C		-25 - +60
Enclosed	°C		-25 - 40
Storage	°C		-40 - 80
Mounting position			
Mechanical shock resistance (IEC/EN 60068-2-27)			
Half-sinusoidal shock, 10 ms			
Main contacts			
N/O contact	g		10
Auxiliary contacts			
N/O contact	g		7
N/C contact	g		5
Mechanical shock resistance (IEC/EN 60068-2-27) when tabletop-mounted			
Half-sinusoidal shock, 10 ms			
Main contacts			
N/O contact	g		10
Auxiliary contacts			
N/O contact	g		7
N/C contact	g		5
Degree of Protection			IP00
Protection against direct contact when actuated from front (EN 50274)			Finger and back-of-hand proof
Altitude	m		Max. 2000
Weight			
DC operated	kg		1.052
Screw connector terminals			
Terminal capacity main cable			
Solid	mm ²		1 x (0.75 - 16) 2 x (0.75 - 16)
Flexible with ferrule	mm ²		1 x (0.75 - 35) 2 x (0.75 - 25)
Stranded	mm ²		1 x (16 - 50) 2 x (16 - 35)
Solid or stranded	AWG		single 14 - 1, double 14 - 2
Flat conductor	Lamellenzahl x Breite x Dicke	mm	2 x (6 x 9 x 0.8)
Stripping length	mm		14
Terminal screw			M6
Tightening torque	Nm		3.3
Tool			
Pozidriv screwdriver	Size		2
Standard screwdriver	mm		0.8 x 5.5 1 x 6
Terminal capacity control circuit cables			

Solid		mm ²	1 x (0.75 - 4) 2 x (0.75 - 2.5)
Flexible with ferrule		mm ²	1 x (0.75 - 2.5) 2 x (0.75 - 2.5)
Solid or stranded		AWG	18 - 14
Stripping length		mm	10
Terminal screw			M3.5
Tightening torque		Nm	1.2
Tool			
Pozidriv screwdriver		Size	2
Standard screwdriver		mm	0.8 x 5.5 1 x 6

Main conducting paths

Rated impulse withstand voltage	U_{imp}	V AC	8000
Overvoltage category/pollution degree			III/3
Rated insulation voltage	U_i	V AC	690
Rated operational voltage	U_e	V AC	690
Safe isolation to EN 61140			
between coil and contacts		V AC	440
between the contacts		V AC	440
Making capacity (p.f. to IEC/EN 60947)			
	Up to 690 V	A	560
Breaking capacity			
220 V 230 V		A	400
380 V 400 V		A	400
500 V		A	400
660 V 690 V		A	250
Short-circuit rating			
Short-circuit protection maximum fuse			
Type "2" coordination			
400 V	gG/gL 500 V	A	63
690 V	gG/gL 690 V	A	50
Type "1" coordination			
400 V	gG/gL 500 V	A	125
690 V	gG/gL 690 V	A	80

AC

AC-1			
Rated operational current			
Conventional free air thermal current, 3 pole, 50 - 60 Hz			
Open			
at 40 °C	$I_{th} = I_e$	A	60
at 50 °C	$I_{th} = I_e$	A	57
at 55 °C	$I_{th} = I_e$	A	55
at 60 °C	$I_{th} = I_e$	A	50
enclosed	I_{th}	A	45
Conventional free air thermal current, 1 pole			
open	I_{th}	A	125
enclosed	I_{th}	A	112
AC-3			
Rated operational current			
Open, 3-pole: 50 – 60 Hz			
Notes			At maximum permissible ambient temperature (open.)
220 V 230 V	I_e	A	40
240 V	I_e	A	40
380 V 400 V	I_e	A	40
415 V	I_e	A	40

440V	I_e	A	40
500 V	I_e	A	40
660 V 690 V	I_e	A	25
380 V 400 V	I_e	A	40
Motor rating	P	kWh	
220 V 230 V	P	kW	12.5
240V	P	kW	13.5
380 V 400 V	P	kW	18.5
415 V	P	kW	24
440 V	P	kW	25
500 V	P	kW	28
660 V 690 V	P	kW	23
AC-4			
Open, 3-pole: 50 – 60 Hz			
220 V 230 V	I_e	A	18
240 V	I_e	A	18
380 V 400 V	I_e	A	18
415 V	I_e	A	18
440 V	I_e	A	18
500 V	I_e	A	18
660 V 690 V	I_e	A	14
Motor rating	P	kWh	
220 V 230 V	P	kW	5
240 V	P	kW	5.5
380 V 400 V	P	kW	9
415 V	P	kW	9.5
440 V	P	kW	10
500 V	P	kW	11
660 V 690 V	P	kW	12
DC			
Rated operational current, open			
DC-1			
60 V	I_e	A	50
110 V	I_e	A	50
220 V	I_e	A	45
Current heat loss			
3 pole, at I_{th} (60°)		W	10.3
Current heat loss at I_e to AC-3/400 V		W	6.6
Impedance per pole		mΩ	1.9
Magnet systems			
Voltage tolerance			
DC operated	Pick-up	x U_c	0.7 - 1.2
Notes			RDC 240 (U_{min} 200 V DC/ U_{max} 240 V DC) Example: $U_S = 0.7 \times U_{min} - 1.2 \times U_{max} / U_S = 0.7 \times 200V - 1.2 \times 240V$ DC
DC operated	Drop-out	x U_c	0.15 - 0.6
Notes			at least smoothed two-phase bridge rectifier or three-phase rectifier
Power consumption of the coil in a cold state and $1.0 \times U_S$			
DC operated	Pick-up	W	24
DC operated	Sealing	W	1
Duty factor		% DF	100
Changeover time at 100 % U_S (recommended value)			
Main contacts			
DC operated		ms	
Closing delay		ms	54
Opening delay		ms	24

Arcing time	ms	10
Electromagnetic compatibility (EMC)		
Emitted interference		to EN 60947-1
Interference immunity		to EN 60947-1
Rating data for approved types		
Switching capacity		
Maximum motor rating		
Three-phase		
200 V 208 V	HP	10
230 V 240 V	HP	15
460 V 480 V	HP	30
575 V 600 V	HP	40
Single-phase		
115 V 120 V	HP	3
230 V 240 V	HP	7.5
General use	A	63
Short Circuit Current Rating		
Basic Rating		
SCCR	kA	10
max. Fuse	A	250
max. CB	A	250
480 V High Fault		
SCCR (fuse)	kA	30/100
max. Fuse	A	250/150 Class J
SCCR (CB)	kA	65
max. CB	A	100
600 V High Fault		
SCCR (fuse)	kA	30/100
max. Fuse	A	250/150 Class J
SCCR (CB)	kA	30
max. CB	A	250
Special Purpose Ratings		
Electrical Discharge Lamps (Ballast)		
480V 60Hz 3phase, 277V 60Hz 1phase	A	79
600V 60Hz 3phase, 347V 60Hz 1phase	A	79
Incandescent Lamps (Tungsten)		
480V 60Hz 3phase, 277V 60Hz 1phase	A	74
600V 60Hz 3phase, 347V 60Hz 1phase	A	74
Resistance Air Heating		
480V 60Hz 3phase, 277V 60Hz 1phase	A	79
600V 60Hz 3phase, 347V 60Hz 1phase	A	79
Elevator Control		
200V 60Hz 3phase	HP	7.5
200V 60Hz 3phase	A	25.3
240V 60Hz 3phase	HP	10
240V 60Hz 3phase	A	28
480V 60Hz 3phase	HP	25
480V 60Hz 3phase	A	34
600V 60Hz 3phase	HP	30
600V 60Hz 3phase	A	32

Design verification as per IEC/EN 61439

Technical data for design verification			
Rated operational current for specified heat dissipation	I_n	A	40
Heat dissipation per pole, current-dependent	P_{vid}	W	2.2
Equipment heat dissipation, current-dependent	P_{vid}	W	6.6
Static heat dissipation, non-current-dependent	P_{vs}	W	1
Heat dissipation capacity	P_{diss}	W	0
Operating ambient temperature min.		°C	-25
Operating ambient temperature max.		°C	60
IEC/EN 61439 design verification			
10.2 Strength of materials and parts			
10.2.2 Corrosion resistance			
			Meets the product standard's requirements.
10.2.3.1 Verification of thermal stability of enclosures			
			Meets the product standard's requirements.
10.2.3.2 Verification of resistance of insulating materials to normal heat			
			Meets the product standard's requirements.
10.2.3.3 Verification of resistance of insulating materials to abnormal heat and fire due to internal electric effects			
			Meets the product standard's requirements.
10.2.4 Resistance to ultra-violet (UV) radiation			
			Meets the product standard's requirements.
10.2.5 Lifting			
			Does not apply, since the entire switchgear needs to be evaluated.
10.2.6 Mechanical impact			
			Does not apply, since the entire switchgear needs to be evaluated.
10.2.7 Inscriptions			
			Meets the product standard's requirements.
10.3 Degree of protection of ASSEMBLIES			
			Does not apply, since the entire switchgear needs to be evaluated.
10.4 Clearances and creepage distances			
			Meets the product standard's requirements.
10.5 Protection against electric shock			
			Does not apply, since the entire switchgear needs to be evaluated.
10.6 Incorporation of switching devices and components			
			Does not apply, since the entire switchgear needs to be evaluated.
10.7 Internal electrical circuits and connections			
			Is the panel builder's responsibility.
10.8 Connections for external conductors			
			Is the panel builder's responsibility.
10.9 Insulation properties			
10.9.2 Power-frequency electric strength			
			Is the panel builder's responsibility.
10.9.3 Impulse withstand voltage			
			Is the panel builder's responsibility.
10.9.4 Testing of enclosures made of insulating material			
			Is the panel builder's responsibility.
10.10 Temperature rise			
			The panel builder is responsible for the temperature rise calculation. Eaton will provide heat dissipation data for the devices.
10.11 Short-circuit rating			
			Is the panel builder's responsibility. The specifications for the switchgear must be observed.
10.12 Electromagnetic compatibility			
			Is the panel builder's responsibility. The specifications for the switchgear must be observed.
10.13 Mechanical function			
			The device meets the requirements, provided the information in the instruction leaflet (IL) is observed.

Technical data ETIM 7.0

Low-voltage industrial components (EG000017) / Power contactor, AC switching (EC000066)			
Electric engineering, automation, process control engineering / Low-voltage switch technology / Contactor (LV) / Power contactor, AC switching (ecl@ss10.0.1-27-37-10-03 [AAB718015])			
Rated control supply voltage U_s at AC 50HZ		V	0 - 0
Rated control supply voltage U_s at AC 60HZ		V	0 - 0
Rated control supply voltage U_s at DC		V	200 - 240
Voltage type for actuating			DC
Rated operation current I_e at AC-1, 400 V		A	60
Rated operation current I_e at AC-3, 400 V		A	40
Rated operation power at AC-3, 400 V		kW	18.5
Rated operation current I_e at AC-4, 400 V		A	18
Rated operation power at AC-4, 400 V		kW	9
Rated operation power NEMA		kW	22
Modular version			No
Number of auxiliary contacts as normally open contact			0
Number of auxiliary contacts as normally closed contact			0
Type of electrical connection of main circuit			Screw connection
Number of normally closed contacts as main contact			0

Number of main contacts as normally open contact

3

Approvals

Product Standards	IEC/EN 60947-4-1; UL 60947-4-1; CSA - C22.2 No. 60947-4-1-14; CE marking
UL File No.	E29096
UL Category Control No.	NLDX
CSA File No.	012528
CSA Class No.	2411-03, 3211-04
North America Certification	UL listed, CSA certified
Specially designed for North America	No

Characteristics

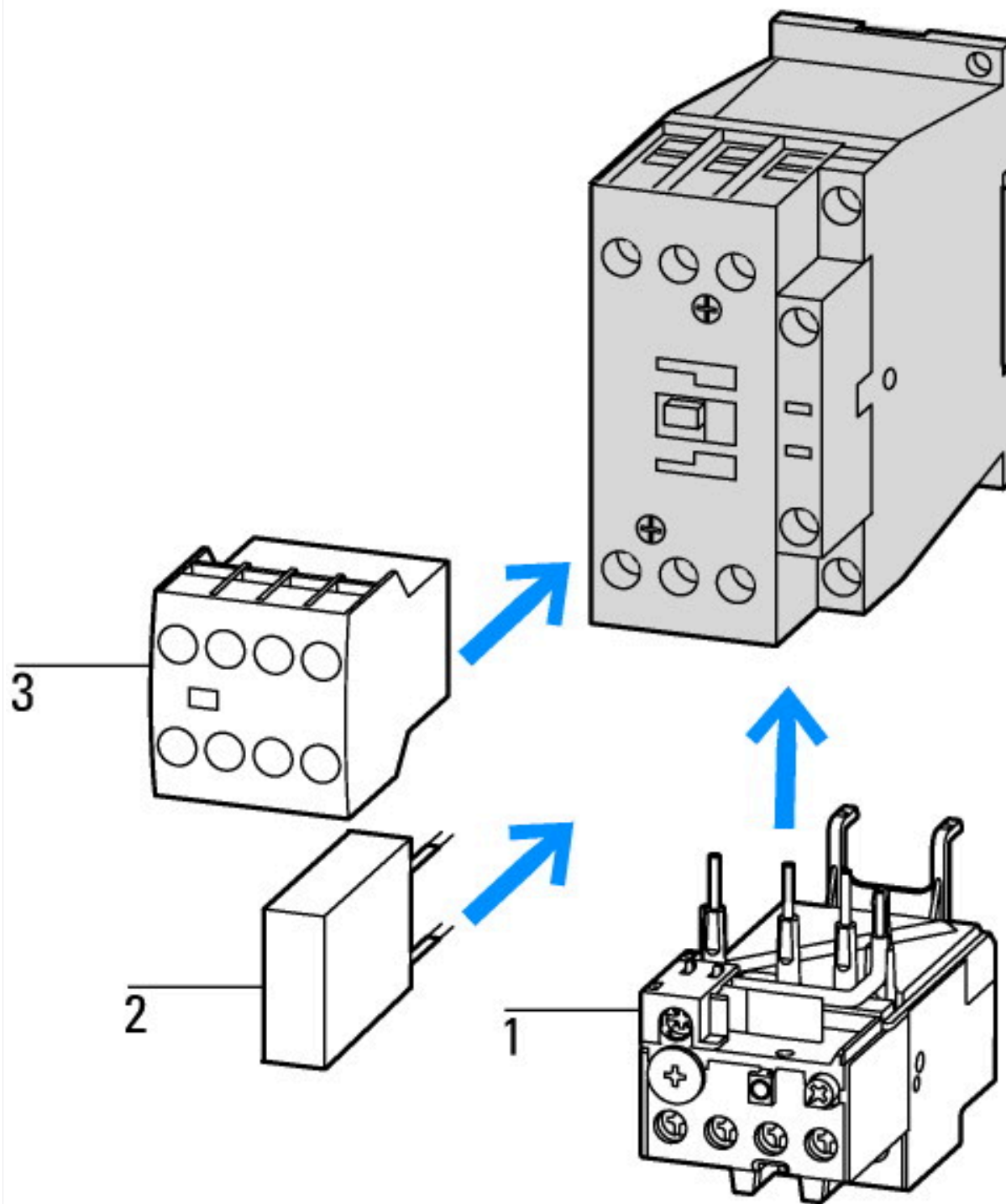

- 1: Overload relay
- 2: Suppressor
- 3: Auxiliary contact modules

DILM1000-XHI(V)11-...

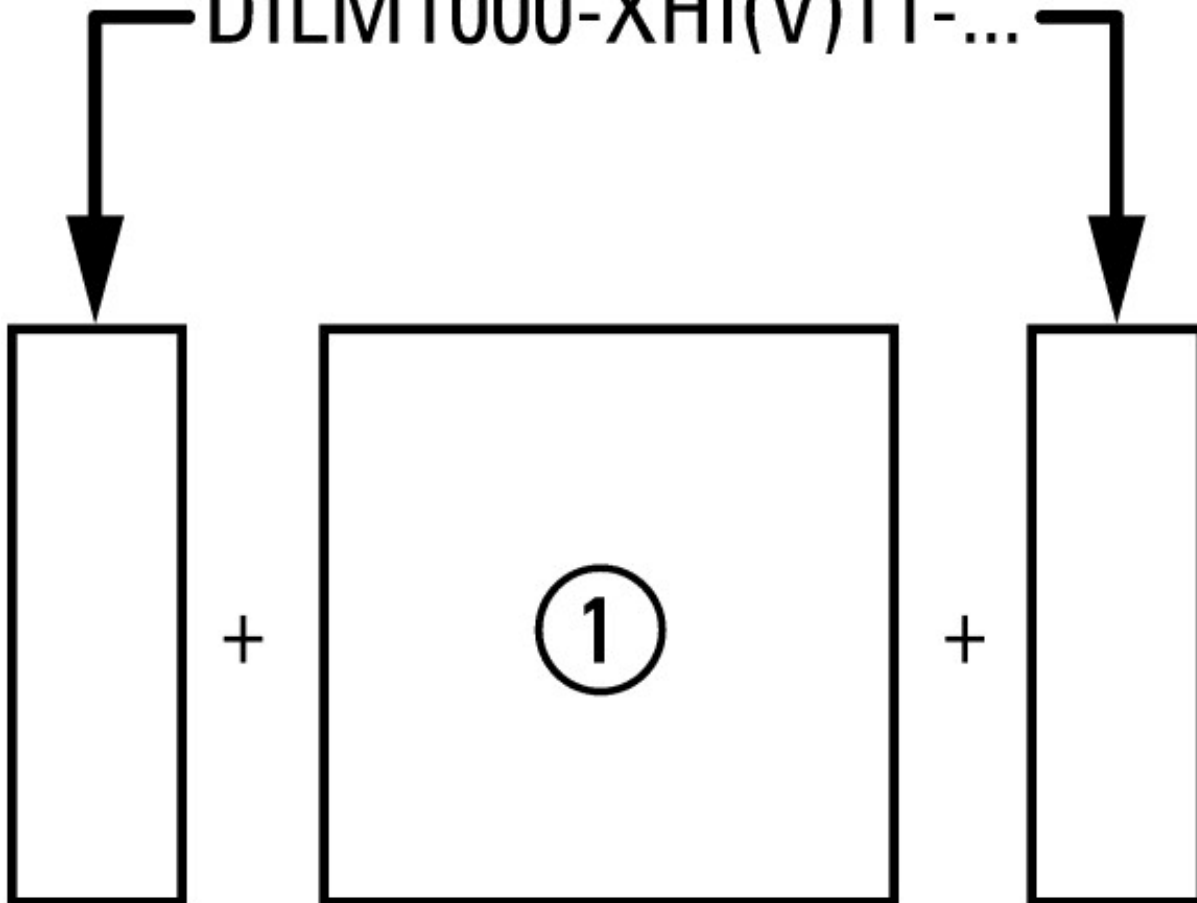

on the side: 2 x DILM1000-XHI(V)11-SI; surface mounting: 1 x DILM150-XHIA11
 on the side: 2 x DILM1000-XHI(V)11-SA; surface mounting: 1 x DILM150-XHI (2 pole)
 on the side: 1 x DILM1000-XHI(V)11-SI; surface mounting: 1 x DILM150-XHIA22
 on the side: 1 x DILM1000-XHI(V)11-SA; surface mounting: 1 x DILM150-XHI (4 pole)

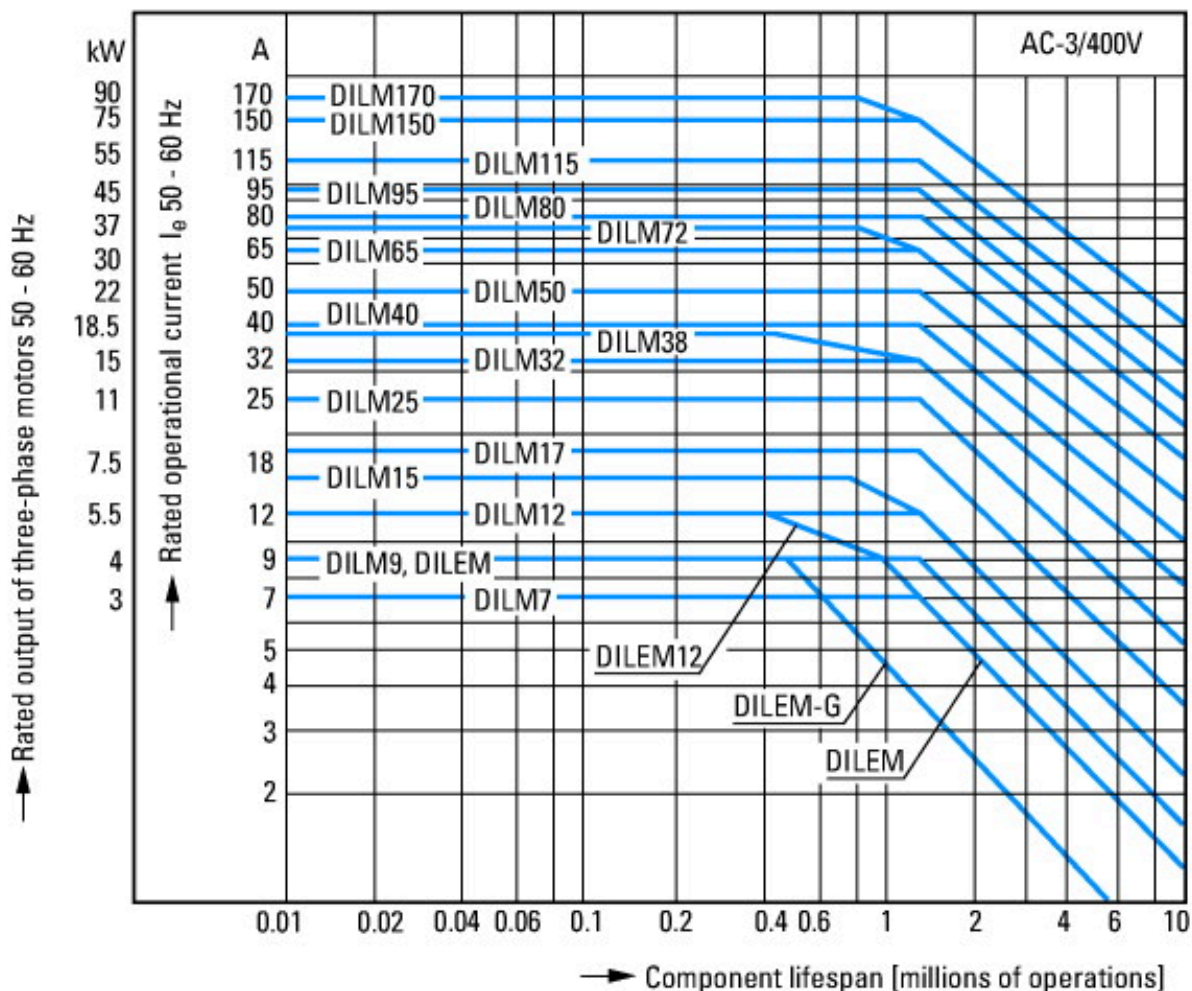

- Squirrel-cage motor
- Operating characteristics
- Starting: from rest
- Stopping: after attaining full running speed
- Electrical characteristics
- Make: up to 6 x rated motor current
- Break: up to 1 x rated motor current
- Utilization category
- 100 % AC-3
- Typical applications
- Compressors
- Lifts
- Mixers
- Pumps
- Escalators
- Agitators
- Fans
- Conveyor belts
- Centrifuges
- Hinged flaps
- Bucket-elevators
- Air conditioning system
- General drives in manufacturing and processing machines

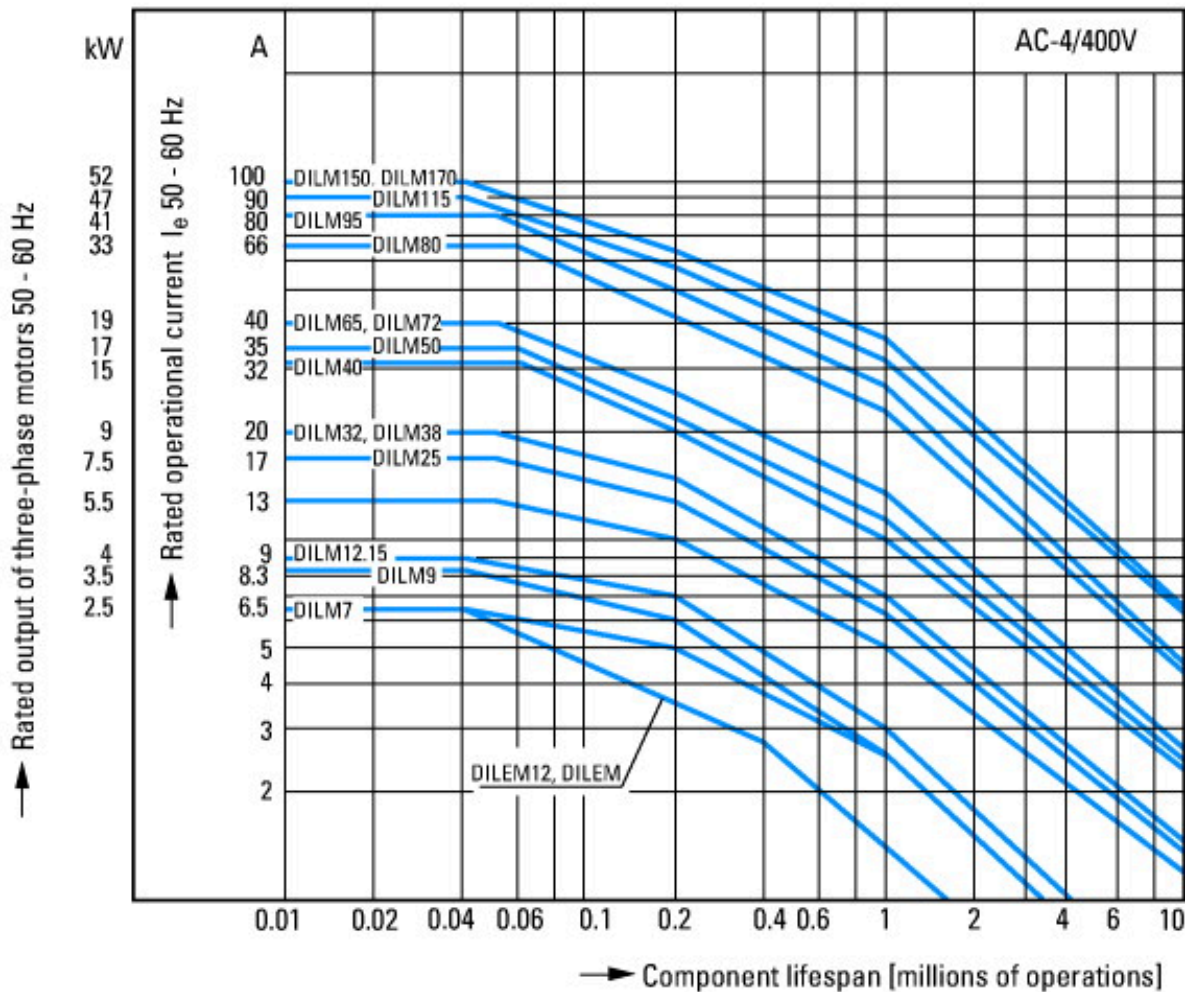

- Extreme switching duty
- Squirrel-cage motor
- Operating characteristics
- Inching, plugging, reversing
- Electrical characteristics
- Make: up to 6 x rated motor current
- Break: up to 6 x rated motor current
- Utilization category
- 100 % AC-4
- Typical applications
- Printing presses
- Wire-drawing machines
- Centrifuges
- Special drives for manufacturing and processing machines



Switching conditions for non-motor consumers, 3 pole, 4 pole
 Operating characteristics
 Non inductive and slightly inductive loads
 Electrical characteristics
 Switch on: 1 x rated operational current
 Switch off: 1 x rated operational current
 Utilization category
 100 % AC-1
 Typical examples of application
 Electric heat

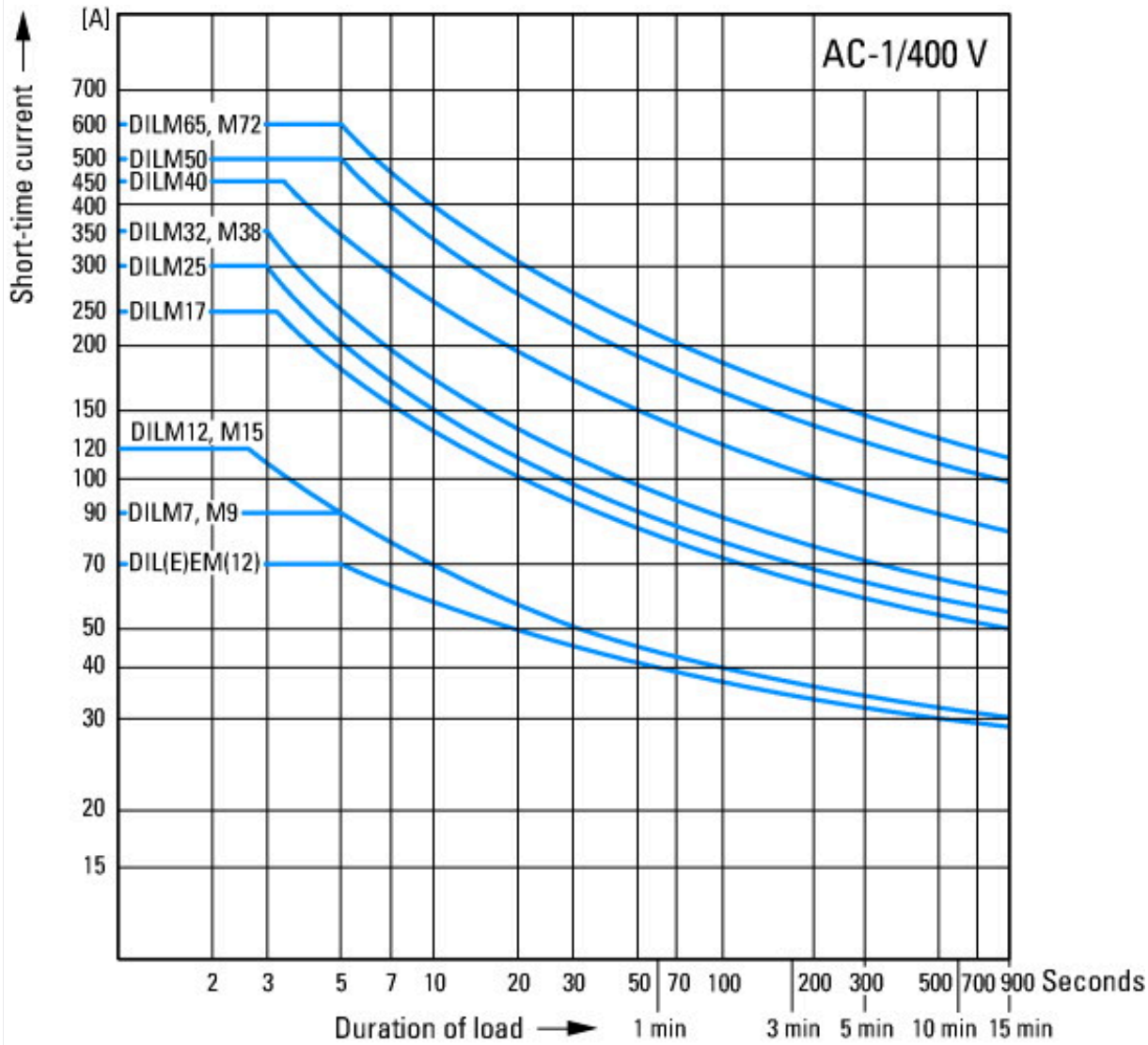

Dimensions

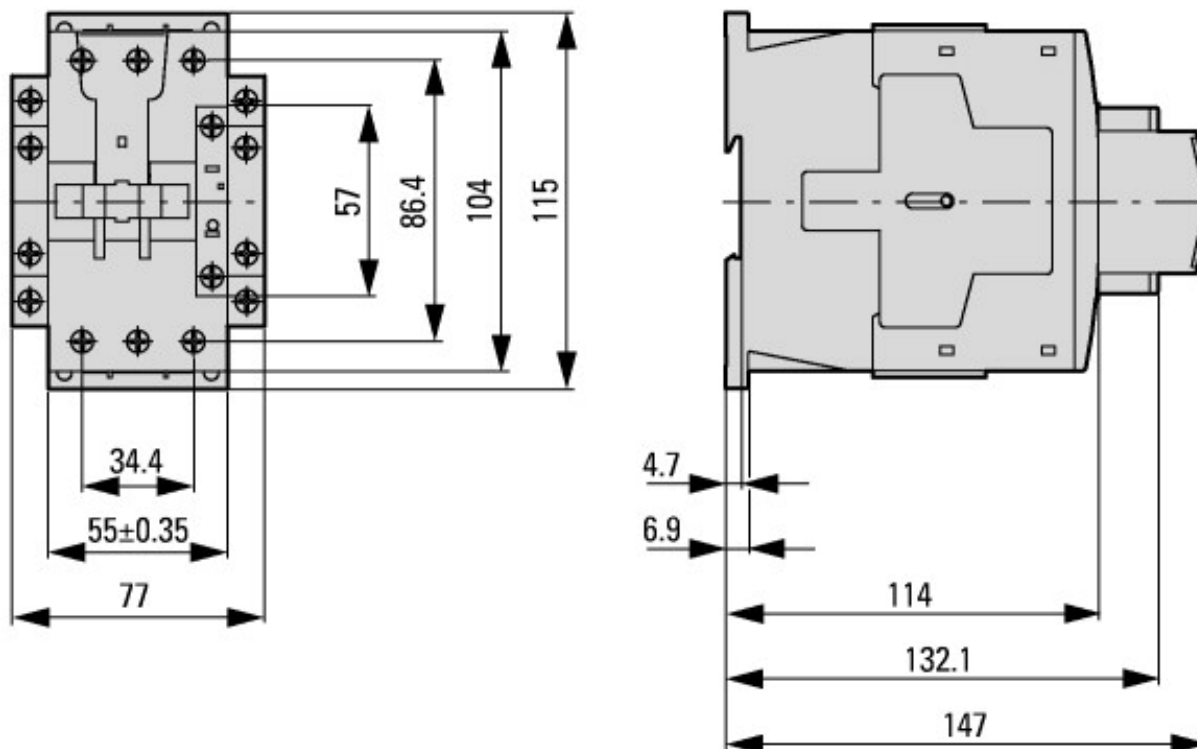

Contactor with auxiliary contact module

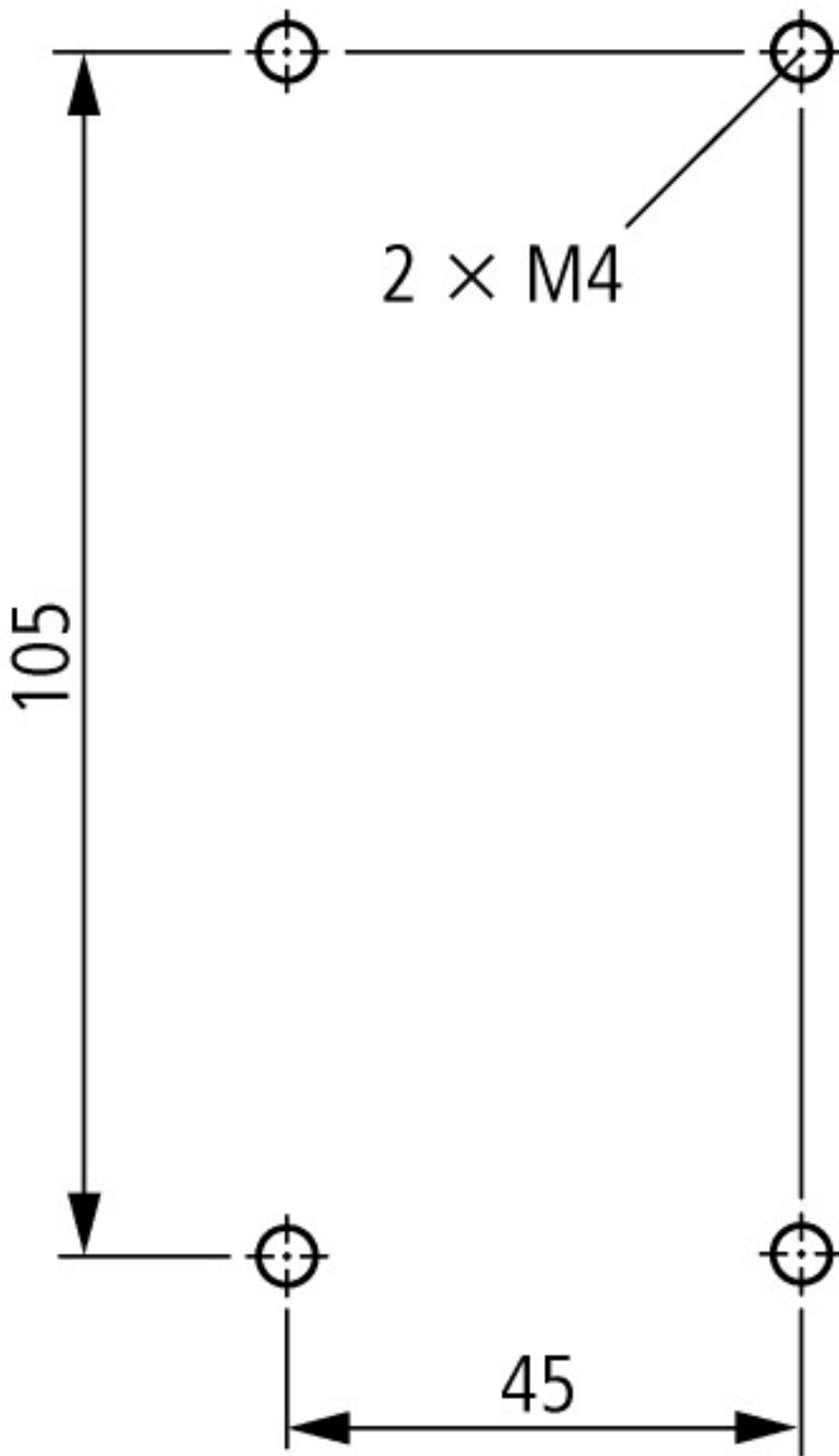

Lateral clearance to earthed parts: 6 mm

DILM40...DILM72
DILMC40...DILMC65
DILMF40...DILMF65



SCATTERGOOD & JOHNSON LTD

ELECTRICAL ENGINEERING & FLUID CONTROL DISTRIBUTORS

Est.1899

At Scattergood & Johnson Ltd, we pride ourselves on being a technical distributor to specialist industries.

Working with a range of quality product suppliers across a number of specialist markets, we are not your average 'box shifter' - we are your technical and supply chain partner.

We fully support every product we sell - for free! Our internal team and external sales engineers can answer any product or application question, no matter the complexity.

Backing up this technical ability is a range of 50,000+ products available from stock for nationwide next day delivery (same day if required!), or you can collect what you need from any of our trade counters around the UK.

Select your specialist interest below to learn more about how we can help.



Online, In Branch and On the Road - Scattergood & Johnson Ltd, there when you need us.

www.scatts.co.uk