

DATASHEET - DILM80(RDC24)

Contactor, 3 pole, 380 V 400 V 37 kW, RDC 24: 24 - 27 V DC, DC operation, Screw terminals



Part no. DILM80(RDC24)
Catalog No. 239416
Alternate Catalog No. XTCE080F00TD
EL-Nummer (Norway) 4134050

Delivery program

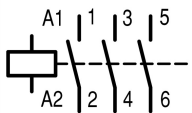
| | | | | |
|---|----------------|----|--|---|
| Product range | | | | Contactors |
| Application | | | | Contactors for Motors |
| Subrange | | | | Contactors up to 170 A, 3 pole |
| Utilization category | | | | AC-1: Non-inductive or slightly inductive loads, resistance furnaces AC-3: Normal AC induction motors: starting, switch off during running AC-4: Normal AC induction motors: starting, plugging, reversing, inching |
| Notes | | | |  Also suitable for motors with efficiency class IE3. IE3-ready devices are identified by the logo on their packaging. |
| Connection technique | | | | Screw terminals |
| Number of poles | | | | 3 pole |
| Rated operational current | | | | |
| AC-3 | | | | |
| Notes | | | | At maximum permissible ambient temperature (open.) |
| 380 V 400 V | I_e | A | | 80 |
| AC-1 | | | | |
| Conventional free air thermal current, 3 pole, 50 - 60 Hz | | | | |
| Open | | | | |
| at 40 °C | $I_{th} = I_e$ | A | | 110 |
| enclosed | I_{th} | A | | 80 |
| Conventional free air thermal current, 1 pole | | | | |
| open | I_{th} | A | | 225 |
| enclosed | I_{th} | A | | 200 |
| Max. rating for three-phase motors, 50 - 60 Hz | | | | |
| AC-3 | | | | |
| 220 V 230 V | P | kW | | 25 |
| 380 V 400 V | P | kW | | 37 |
| 660 V 690 V | P | kW | | 63 |
| AC-4 | | | | |
| 220 V 230 V | P | kW | | 11.5 |
| 380 V 400 V | P | kW | | 20 |
| 660 V 690 V | P | kW | | 26 |
| Contact sequence | | | |  |
| Instructions | | | | Contacts to EN 50 012. integrated suppressor circuit in actuating electronics |
| Can be combined with auxiliary contact | | | | DILM150-XHI(V).. DILM1000-XHI(V).. |
| Actuating voltage | | | | RDC 24: 24 - 27 V DC |
| Voltage AC/DC | | | | DC operation |
| Connection to SmartWire-DT | | | | no |

Technical data

General

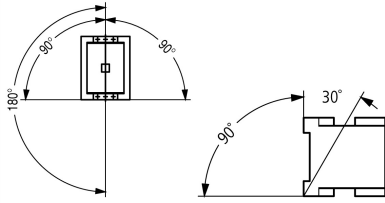
| | | | |
|---|-------------------------------------|-----------------|--|
| Standards | | | IEC/EN 60947, VDE 0660, UL, CSA |
| Lifespan, mechanical | | | |
| DC operated | Operations | $\times 10^6$ | 10 |
| Operating frequency, mechanical | | | |
| DC operated | Operations/h | | 3600 |
| Climatic proofing | | | Damp heat, constant, to IEC 60068-2-78 Damp heat, cyclic, to IEC 60068-2-30 |
| Ambient temperature | | | |
| Open | | °C | -25 - +60 |
| Enclosed | | °C | -25 - 40 |
| Storage | | °C | -40 - 80 |
| Mounting position | | |  |
| Mechanical shock resistance (IEC/EN 60068-2-27) | | | |
| Half-sinusoidal shock, 10 ms | | | |
| Main contacts | | | |
| N/O contact | | g | 10 |
| Auxiliary contacts | | | |
| N/O contact | | g | 7 |
| N/C contact | | g | 5 |
| Mechanical shock resistance (IEC/EN 60068-2-27) when tabletop-mounted | | | |
| Half-sinusoidal shock, 10 ms | | | |
| Main contacts | | | |
| N/O contact | | g | 10 |
| Auxiliary contacts | | | |
| N/O contact | | g | 7 |
| N/C contact | | g | 5 |
| Degree of Protection | | | IP00 |
| Protection against direct contact when actuated from front (EN 50274) | | | Finger and back-of-hand proof |
| Altitude | | m | Max. 2000 |
| Weight | | | |
| DC operated | | kg | 2.25 |
| Screw connector terminals | | | |
| Terminal capacity main cable | | | |
| Flexible with ferrule | | mm ² | 1 x (10 - 70) 2 x (10 - 50) |
| Stranded | | mm ² | 1 x (16 - 70) 2 x (16 - 50) |
| Solid or stranded | | AWG | single 8...3/0, double 8...2/0 |
| Flat conductor | Lamellenzahl x Breite x Dicke | mm | 2 x (6 x 16 x 0.8) |
| Stripping length | | mm | 24 |
| Terminal screw | | | M10 |
| Tightening torque | | Nm | 14 |
| Tool | | | |
| Hexagon socket-head spanner | SW | mm | 5 |
| Terminal capacity control circuit cables | | | |
| Solid | | mm ² | 1 x (0.75 - 4) 2 x (0.75 - 2.5) |
| Flexible with ferrule | | mm ² | 1 x (0.75 - 2.5) 2 x (0.75 - 2.5) |

| | | | |
|----------------------|--|------|--------------------|
| Solid or stranded | | AWG | 18 - 14 |
| Stripping length | | mm | 10 |
| Terminal screw | | | M3.5 |
| Tightening torque | | Nm | 1.2 |
| Tool | | | |
| Pozidriv screwdriver | | Size | 2 |
| Standard screwdriver | | mm | 0.8 x 5.5 1 x 6 |

Main conducting paths

| | | | |
|--|-------------|------|-------|
| Rated impulse withstand voltage | U_{imp} | V AC | 8000 |
| Overvoltage category/pollution degree | | | III/3 |
| Rated insulation voltage | U_i | V AC | 690 |
| Rated operational voltage | U_e | V AC | 690 |
| Safe isolation to EN 61140 | | | |
| between coil and contacts | | V AC | 690 |
| between the contacts | | V AC | 690 |
| Making capacity (p.f. to IEC/EN 60947) | | | |
| | Up to 690 V | A | 1120 |
| Breaking capacity | | | |
| 220 V 230 V | | A | 800 |
| 380 V 400 V | | A | 800 |
| 500 V | | A | 800 |
| 660 V 690 V | | A | 650 |
| Short-circuit rating | | | |
| Short-circuit protection maximum fuse | | | |
| Type "2" coordination | | | |
| 400 V | gG/gL 500 V | A | 160 |
| 690 V | gG/gL 690 V | A | 160 |
| Type "1" coordination | | | |
| 400 V | gG/gL 500 V | A | 250 |
| 690 V | gG/gL 690 V | A | 200 |

AC

| | | | |
|---|----------------|---|--|
| AC-1 | | | |
| Rated operational current | | | |
| Conventional free air thermal current, 3 pole, 50 - 60 Hz | | | |
| Open | | | |
| at 40 °C | $I_{th} = I_e$ | A | 110 |
| at 50 °C | $I_{th} = I_e$ | A | 98 |
| at 55 °C | $I_{th} = I_e$ | A | 94 |
| at 60 °C | $I_{th} = I_e$ | A | 90 |
| enclosed | I_{th} | A | 80 |
| Conventional free air thermal current, 1 pole | | | |
| open | I_{th} | A | 225 |
| enclosed | I_{th} | A | 200 |
| AC-3 | | | |
| Rated operational current | | | |
| Open, 3-pole: 50 – 60 Hz | | | |
| Notes | | | At maximum permissible ambient temperature (open.) |
| 220 V 230 V | I_e | A | 80 |
| 240 V | I_e | A | 80 |
| 380 V 400 V | I_e | A | 80 |
| 415 V | I_e | A | 80 |
| 440V | I_e | A | 80 |
| 500 V | I_e | A | 80 |
| 660 V 690 V | I_e | A | 65 |

| | | | |
|--------------------------|----------------|-----|------|
| 380 V 400 V | I _e | A | 80 |
| Motor rating | P | kWh | |
| 220 V 230 V | P | kW | 25 |
| 240V | P | kW | 27.5 |
| 380 V 400 V | P | kW | 37 |
| 415 V | P | kW | 48 |
| 440 V | P | kW | 51 |
| 500 V | P | kW | 58 |
| 660 V 690 V | P | kW | 63 |
| AC-4 | | | |
| Open, 3-pole: 50 – 60 Hz | | | |
| 220 V 230 V | I _e | A | 40 |
| 240 V | I _e | A | 40 |
| 380 V 400 V | I _e | A | 40 |
| 415 V | I _e | A | 40 |
| 440 V | I _e | A | 40 |
| 500 V | I _e | A | 40 |
| 660 V 690 V | I _e | A | 27 |
| Motor rating | P | kWh | |
| 220 V 230 V | P | kW | 11.5 |
| 240 V | P | kW | 13 |
| 380 V 400 V | P | kW | 20 |
| 415 V | P | kW | 24 |
| 440 V | P | kW | 25 |
| 500 V | P | kW | 29 |
| 660 V 690 V | P | kW | 26 |

DC

| | | | |
|---------------------------------|----------------|---|-----|
| Rated operational current, open | | | |
| DC-1 | | | |
| 60 V | I _e | A | 110 |
| 110 V | I _e | A | 110 |
| 220 V | I _e | A | 70 |

Current heat loss

| | | | |
|---|--|----|------|
| 3 pole, at I _{th} (60°) | | W | 11.4 |
| Current heat loss at I _e to AC-3/400 V | | W | 9 |
| Impedance per pole | | mΩ | 0.6 |

Magnet systems

| | | | |
|--|----------|------------------|---|
| Voltage tolerance | | | |
| DC operated | Pick-up | x U _c | 0.7 - 1.2 |
| Notes | | | RDC 24 (U _{min} 24 V DC/U _{max} 27 V DC) Example: U _S = 0.7 x U _{min} - 1.2 x U _{max} / U _S = 0.7 x 24V - 1.2 x 27V DC |
| DC operated | Drop-out | x U _c | 0.15 - 0.6 |
| Notes | | | at least smoothed two-phase bridge rectifier or three-phase rectifier |
| Power consumption of the coil in a cold state and 1.0 x U _S | | | |
| DC operated | Pick-up | W | 90 |
| DC operated | Sealing | W | 1.5 |
| Duty factor | | % DF | 100 |
| Changeover time at 100 % U _S (recommended value) | | | |
| Main contacts | | | |
| DC operated | | ms | |
| Closing delay | | ms | 45 |
| Opening delay | | ms | 34 |
| Arcing time | | ms | 15 |
| Permissible residual current with actuation of A1 - A2 by the electronics (with 0 signal). | | mA | ≤ 1 |

Electromagnetic compatibility (EMC)

| | | | |
|---|--|------|-----------------|
| Emitted interference | | | to EN 60947-1 |
| Interference immunity | | | to EN 60947-1 |
| Rating data for approved types | | | |
| Switching capacity | | | |
| Maximum motor rating | | | |
| Three-phase | | | |
| 200 V 208 V | | HP | 25 |
| 230 V 240 V | | HP | 30 |
| 460 V 480 V | | HP | 60 |
| 575 V 600 V | | HP | 75 |
| Single-phase | | | |
| 115 V 120 V | | HP | 7.5 |
| 230 V 240 V | | HP | 15 |
| General use | | A | 125 |
| Short Circuit Current Rating | | SCCR | |
| Basic Rating | | | |
| SCCR | | kA | 10 |
| max. Fuse | | A | 600 |
| max. CB | | A | 600 |
| 480 V High Fault | | | |
| SCCR (fuse) | | kA | 30/100 |
| max. Fuse | | A | 300/300 Class J |
| SCCR (CB) | | kA | 65 |
| max. CB | | A | 250 |
| 600 V High Fault | | | |
| SCCR (fuse) | | kA | 30/100 |
| max. Fuse | | A | 300/300 Class J |
| SCCR (CB) | | kA | 30 |
| max. CB | | A | 350 |
| Special Purpose Ratings | | | |
| Electrical Discharge Lamps (Ballast) | | | |
| 480V 60Hz 3phase, 277V 60Hz 1phase | | A | 100 |
| 600V 60Hz 3phase, 347V 60Hz 1phase | | A | 100 |
| Incandescent Lamps (Tungsten) | | | |
| 480V 60Hz 3phase, 277V 60Hz 1phase | | A | 100 |
| 600V 60Hz 3phase, 347V 60Hz 1phase | | A | 100 |
| Resistance Air Heating | | | |
| 480V 60Hz 3phase, 277V 60Hz 1phase | | A | 100 |
| 600V 60Hz 3phase, 347V 60Hz 1phase | | A | 100 |
| Refrigeration Control (CSA only) | | | |
| LRA 480V 60Hz 3phase | | A | 540 |
| FLA 480V 60Hz 3phase | | A | 90 |
| LRA 600V 60Hz 3phase | | A | 420 |
| FLA 600V 60Hz 3phase | | A | 70 |
| Definite Purpose Ratings (100,000 cycles acc. to UL 1995) | | | |
| LRA 480V 60Hz 3phase | | A | 480 |
| FLA 480V 60Hz 3phase | | A | 80 |
| Elevator Control | | | |
| 200V 60Hz 3phase | | HP | 20 |
| 200V 60Hz 3phase | | A | 62.1 |
| 240V 60Hz 3phase | | HP | 25 |

| | | |
|------------------|----|----|
| 240V 60Hz 3phase | A | 68 |
| 480V 60Hz 3phase | HP | 50 |
| 480V 60Hz 3phase | A | 65 |
| 600V 60Hz 3phase | HP | 60 |
| 600V 60Hz 3phase | A | 62 |

Design verification as per IEC/EN 61439

| Technical data for design verification | | | |
|--|------------|----|--|
| Rated operational current for specified heat dissipation | I_n | A | 80 |
| Heat dissipation per pole, current-dependent | P_{vid} | W | 3 |
| Equipment heat dissipation, current-dependent | P_{vid} | W | 9 |
| Static heat dissipation, non-current-dependent | P_{vs} | W | 1.5 |
| Heat dissipation capacity | P_{diss} | W | 0 |
| Operating ambient temperature min. | | °C | -25 |
| Operating ambient temperature max. | | °C | 60 |
| IEC/EN 61439 design verification | | | |
| 10.2 Strength of materials and parts | | | |
| 10.2.2 Corrosion resistance | | | |
| | | | Meets the product standard's requirements. |
| 10.2.3.1 Verification of thermal stability of enclosures | | | |
| | | | Meets the product standard's requirements. |
| 10.2.3.2 Verification of resistance of insulating materials to normal heat | | | |
| | | | Meets the product standard's requirements. |
| 10.2.3.3 Verification of resistance of insulating materials to abnormal heat and fire due to internal electric effects | | | |
| | | | Meets the product standard's requirements. |
| 10.2.4 Resistance to ultra-violet (UV) radiation | | | |
| | | | Meets the product standard's requirements. |
| 10.2.5 Lifting | | | |
| | | | Does not apply, since the entire switchgear needs to be evaluated. |
| 10.2.6 Mechanical impact | | | |
| | | | Does not apply, since the entire switchgear needs to be evaluated. |
| 10.2.7 Inscriptions | | | |
| | | | Meets the product standard's requirements. |
| 10.3 Degree of protection of ASSEMBLIES | | | |
| | | | Does not apply, since the entire switchgear needs to be evaluated. |
| 10.4 Clearances and creepage distances | | | |
| | | | Meets the product standard's requirements. |
| 10.5 Protection against electric shock | | | |
| | | | Does not apply, since the entire switchgear needs to be evaluated. |
| 10.6 Incorporation of switching devices and components | | | |
| | | | Does not apply, since the entire switchgear needs to be evaluated. |
| 10.7 Internal electrical circuits and connections | | | |
| | | | Is the panel builder's responsibility. |
| 10.8 Connections for external conductors | | | |
| | | | Is the panel builder's responsibility. |
| 10.9 Insulation properties | | | |
| 10.9.2 Power-frequency electric strength | | | |
| | | | Is the panel builder's responsibility. |
| 10.9.3 Impulse withstand voltage | | | |
| | | | Is the panel builder's responsibility. |
| 10.9.4 Testing of enclosures made of insulating material | | | |
| | | | Is the panel builder's responsibility. |
| 10.10 Temperature rise | | | |
| | | | The panel builder is responsible for the temperature rise calculation. Eaton will provide heat dissipation data for the devices. |
| 10.11 Short-circuit rating | | | |
| | | | Is the panel builder's responsibility. The specifications for the switchgear must be observed. |
| 10.12 Electromagnetic compatibility | | | |
| | | | Is the panel builder's responsibility. The specifications for the switchgear must be observed. |
| 10.13 Mechanical function | | | |
| | | | The device meets the requirements, provided the information in the instruction leaflet (IL) is observed. |

Technical data ETIM 7.0

| Low-voltage industrial components (EG000017) / Power contactor, AC switching (EC000066) | | | |
|---|----|--|---------|
| Electric engineering, automation, process control engineering / Low-voltage switch technology / Contactor (LV) / Power contactor, AC switching (ecl@ss10.0.1-27-37-10-03 [AAB718015]) | | | |
| Rated control supply voltage U_s at AC 50HZ | V | | 0 - 0 |
| Rated control supply voltage U_s at AC 60HZ | V | | 0 - 0 |
| Rated control supply voltage U_s at DC | V | | 24 - 27 |
| Voltage type for actuating | | | DC |
| Rated operation current I_e at AC-1, 400 V | A | | 110 |
| Rated operation current I_e at AC-3, 400 V | A | | 80 |
| Rated operation power at AC-3, 400 V | kW | | 37 |
| Rated operation current I_e at AC-4, 400 V | A | | 40 |
| Rated operation power at AC-4, 400 V | kW | | 20 |

| | | | |
|---|--|----|------------------|
| Rated operation power NEMA | | kW | 44.7 |
| Modular version | | | No |
| Number of auxiliary contacts as normally open contact | | | 0 |
| Number of auxiliary contacts as normally closed contact | | | 0 |
| Type of electrical connection of main circuit | | | Screw connection |
| Number of normally closed contacts as main contact | | | 0 |
| Number of main contacts as normally open contact | | | 3 |

Approvals

| | | | |
|--------------------------------------|--|--|--|
| Product Standards | | | IEC/EN 60947-4-1; UL 60947-4-1; CSA - C22.2 No. 60947-4-1-14; CE marking |
| UL File No. | | | E29096 |
| UL Category Control No. | | | NLDX |
| CSA File No. | | | 012528 |
| CSA Class No. | | | 2411-03, 3211-04 |
| North America Certification | | | UL listed, CSA certified |
| Specially designed for North America | | | No |

Characteristics



- 1: Overload relay
- 2: Suppressor
- 3: Auxiliary contact modules

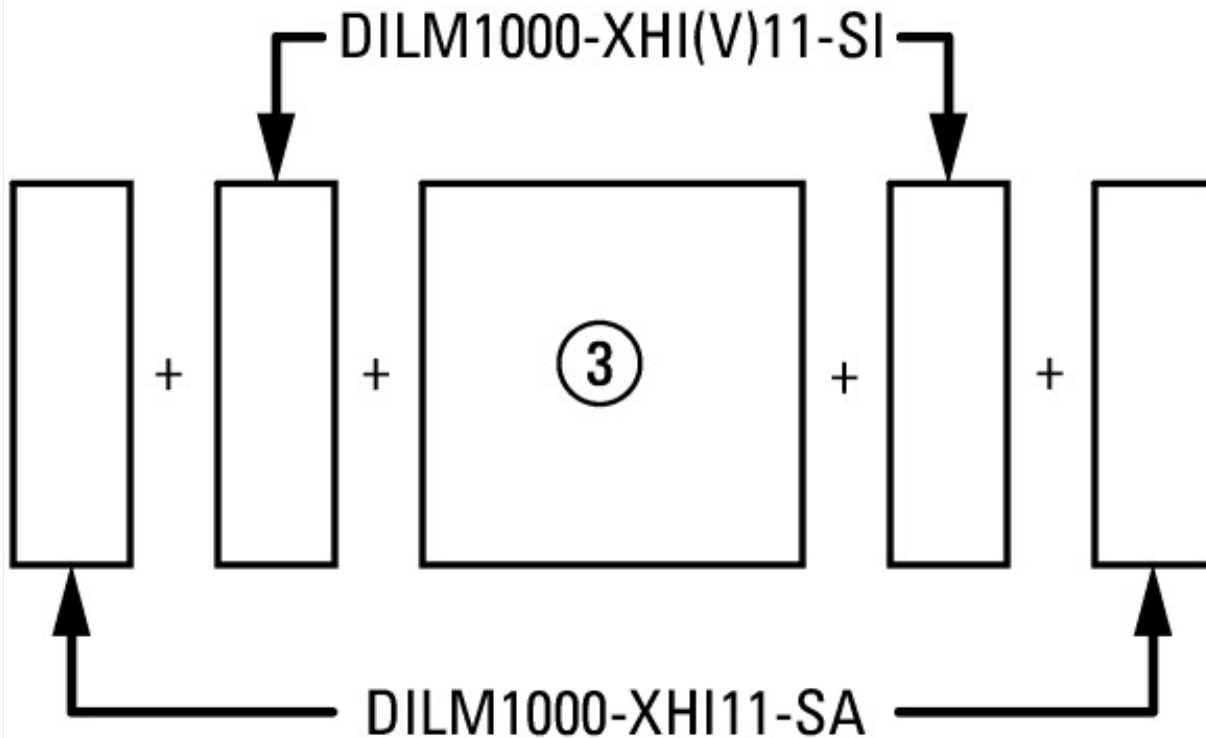

on the side: 2 x DILM820-XHI11(V)-SI; 2 x DILM820-XHI11-SA

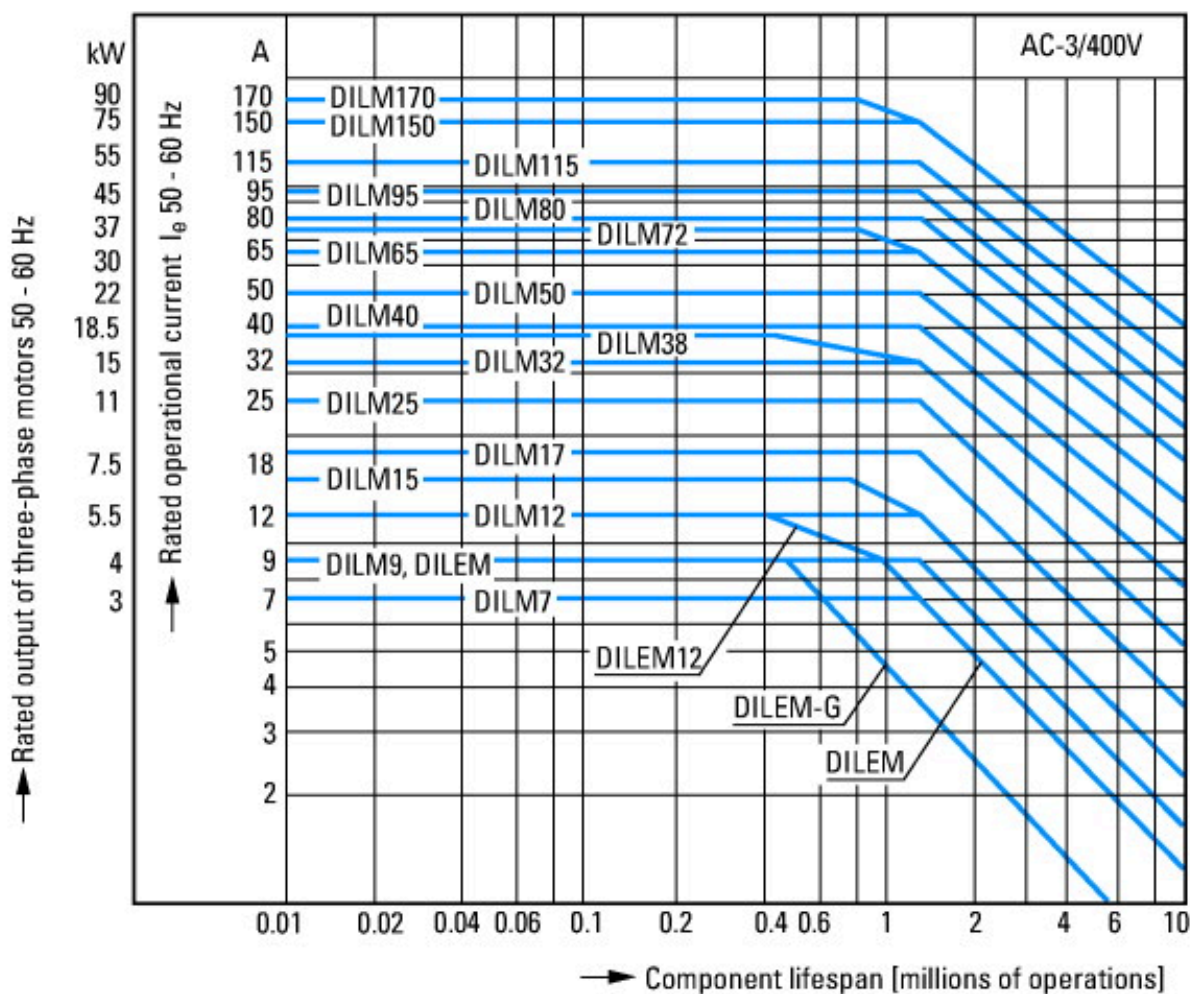

Squirrel-cage motor
 Operating characteristics
 Starting: from rest
 Stopping: after attaining full running speed
 Electrical characteristics
 Make: up to 6 x rated motor current
 Break: up to 1 x rated motor current
 Utilization category
 100 % AC-3
 Typical applications

- Compressors
- Lifts
- Mixers
- Pumps
- Escalators
- Agitators
- Fans
- Conveyor belts
- Centrifuges
- Hinged flaps
- Bucket-elevators
- Air conditioning system
- General drives in manufacturing and processing machines

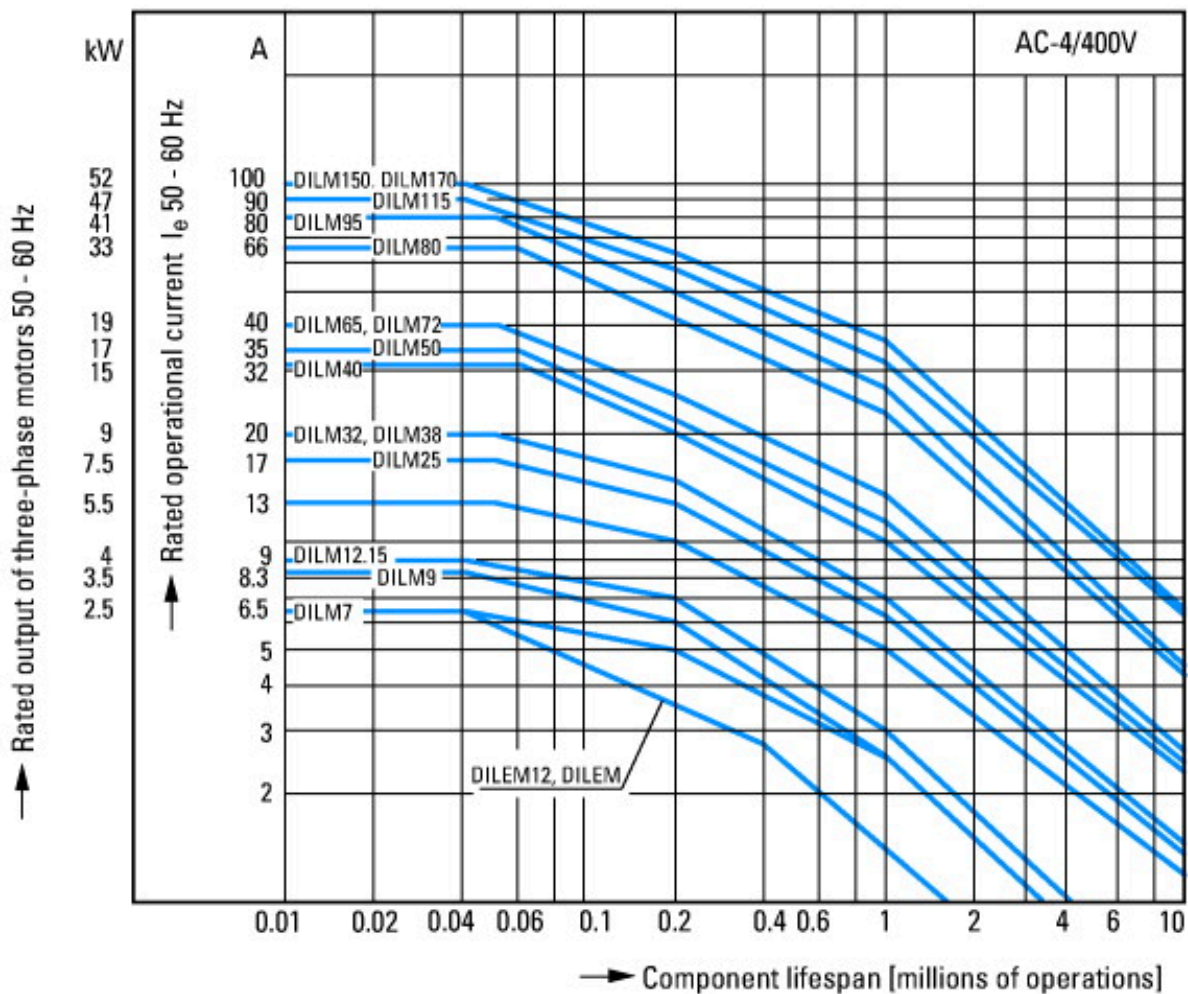

- Extreme switching duty
- Squirrel-cage motor
- Operating characteristics
- Inching, plugging, reversing
- Electrical characteristics
- Make: up to 6 x rated motor current
- Break: up to 6 x rated motor current
- Utilization category
- 100 % AC-4
- Typical applications
- Printing presses
- Wire-drawing machines
- Centrifuges
- Special drives for manufacturing and processing machines



Switching conditions for non-motor consumers, 3 pole, 4 pole
 Operating characteristics
 Non inductive and slightly inductive loads
 Electrical characteristics
 Switch on: 1 x rated operational current
 Switch off: 1 x rated operational current
 Utilization category
 100 % AC-1
 Typical examples of application
 Electric heat

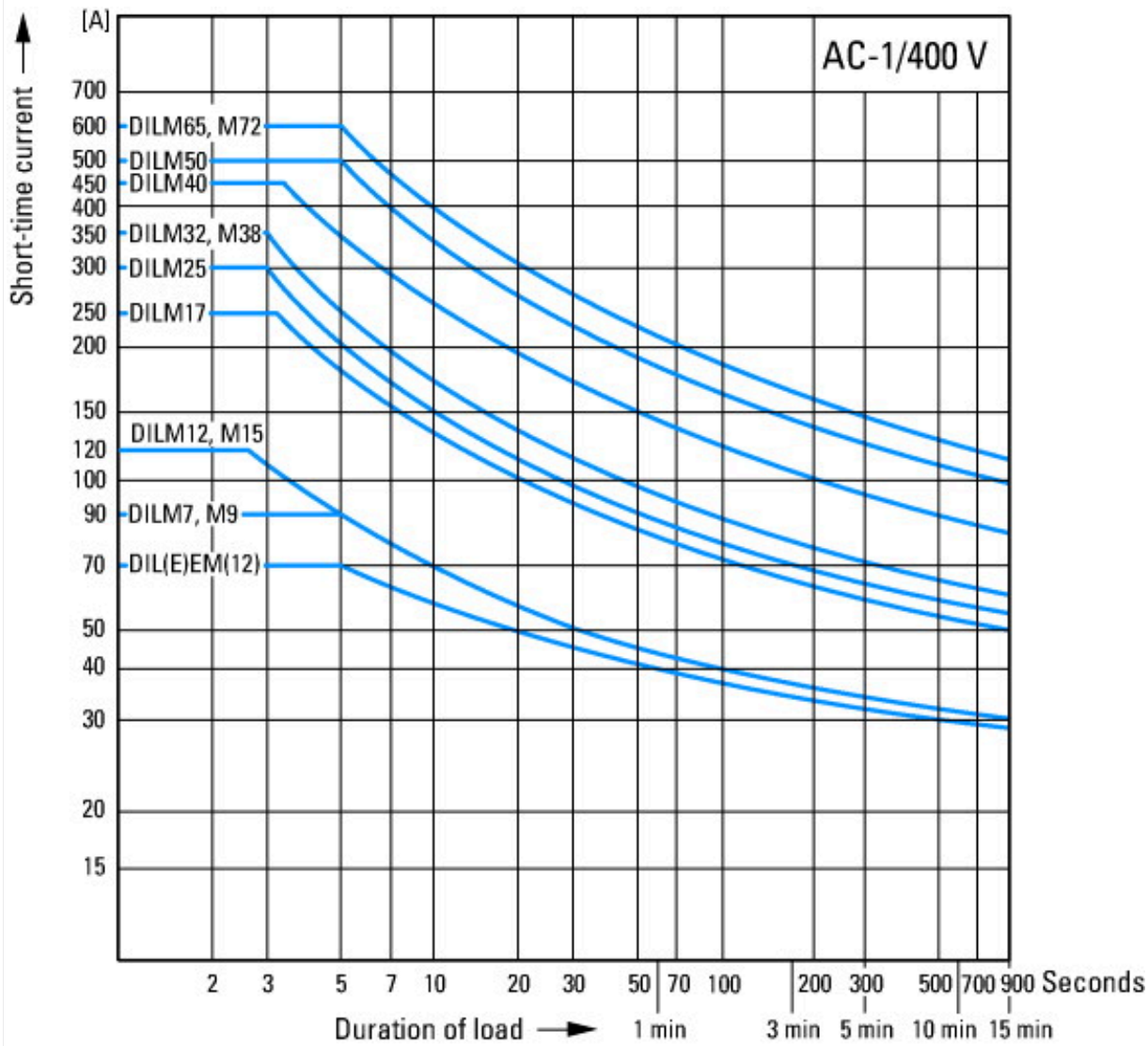

Dimensions

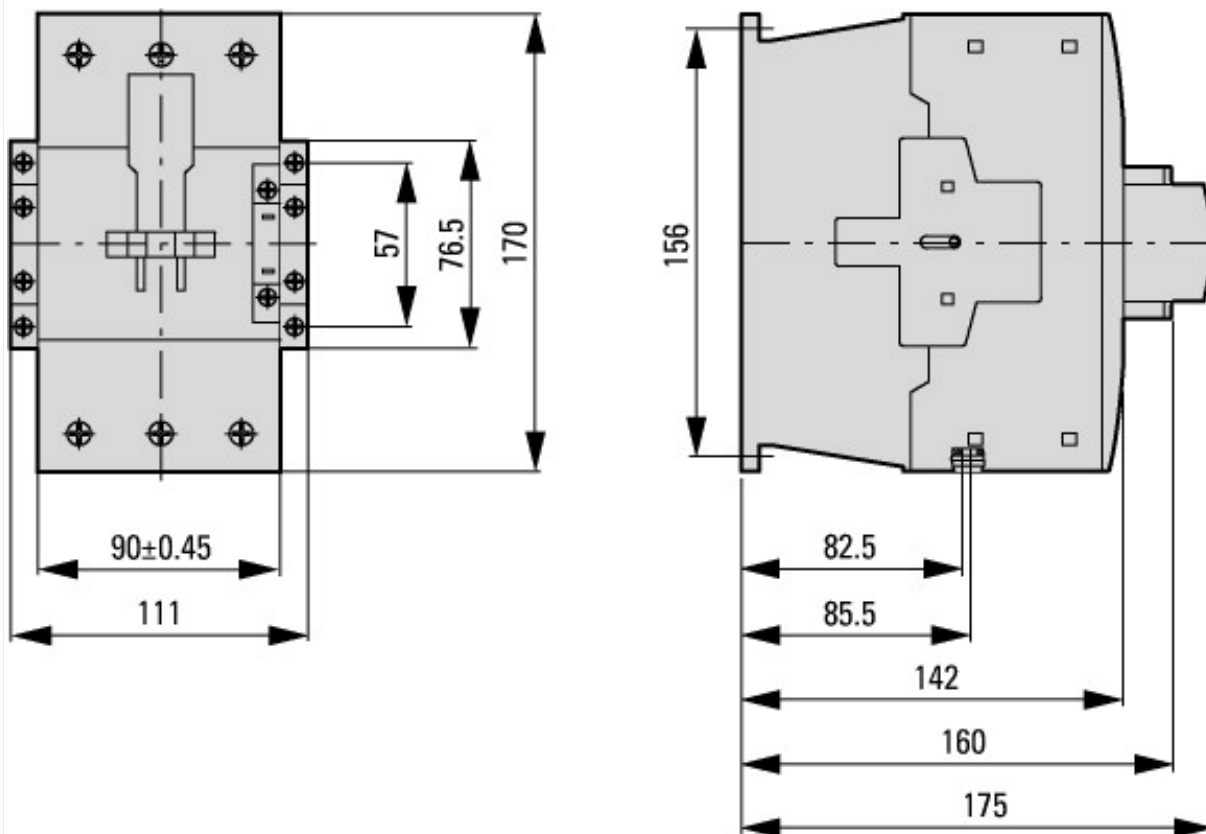

Contactors with auxiliary contact module

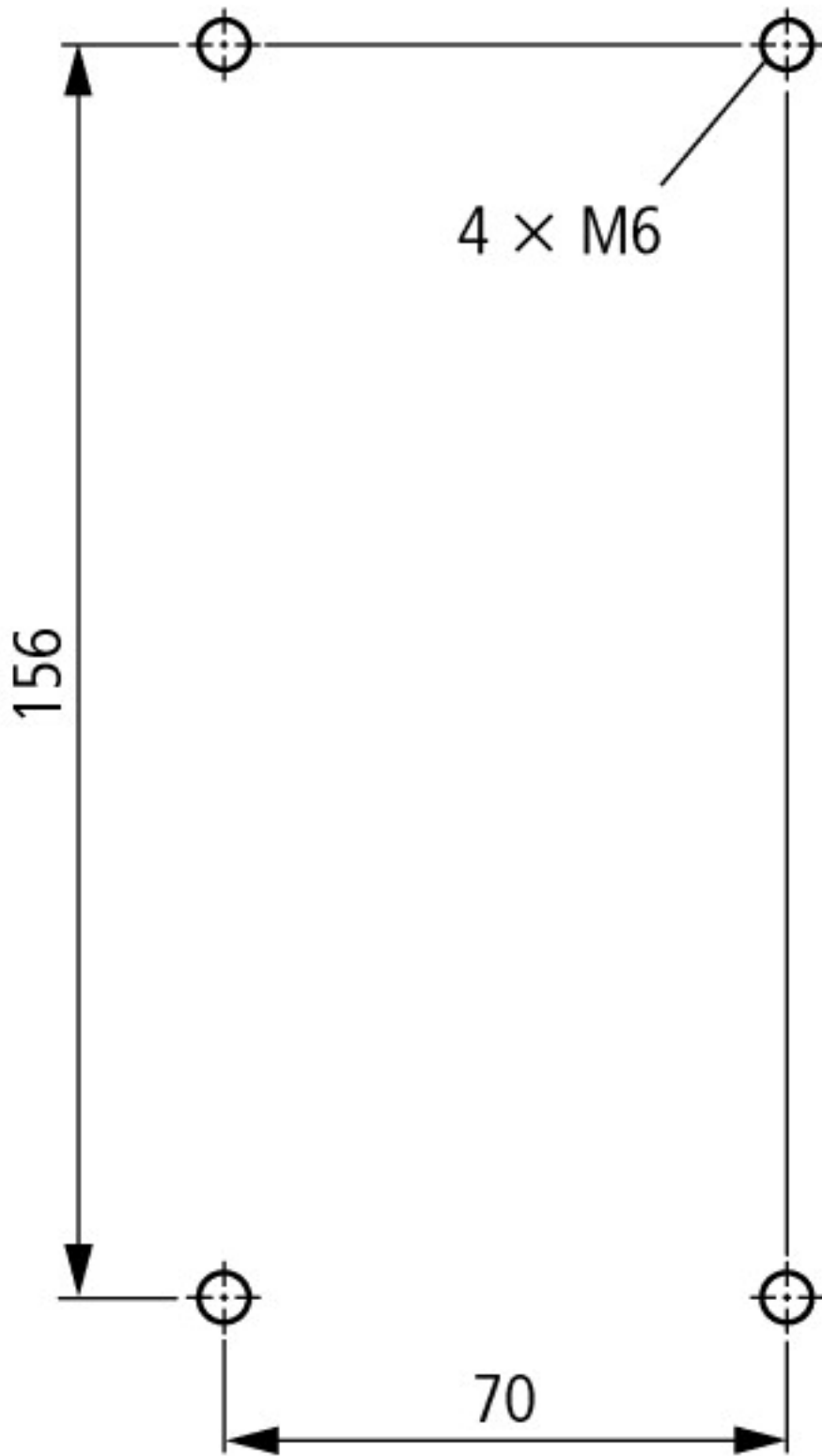

distance at side to earthed parts: 10 mm

DILM80...DILM170
DILMC80...DILMC150
DILMF80...DILMF150



SCATTERGOOD & JOHNSON LTD

ELECTRICAL ENGINEERING & FLUID CONTROL DISTRIBUTORS

Est.1899

At Scattergood & Johnson Ltd, we pride ourselves on being a technical distributor to specialist industries.

Working with a range of quality product suppliers across a number of specialist markets, we are not your average 'box shifter' - we are your technical and supply chain partner.

We fully support every product we sell - for free! Our internal team and external sales engineers can answer any product or application question, no matter the complexity.

Backing up this technical ability is a range of 50,000+ products available from stock for nationwide next day delivery (same day if required!), or you can collect what you need from any of our trade counters around the UK.

Select your specialist interest below to learn more about how we can help.



Online, In Branch and On the Road - Scattergood & Johnson Ltd, there when you need us.

www.scatts.co.uk