

DATASHEET - DILM95(400V50HZ,440V60HZ)

Contactor, 3 pole, 380 V 400 V 45 kW, 400 V 50 Hz, 440 V 60 Hz, AC operation, Screw terminals



Part no. DILM95(400V50HZ,440V60HZ)
Catalog No. 239482
Alternate Catalog No. XTCE095F0013

Delivery program

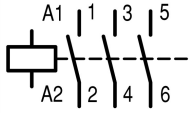
Product range				Contactors
Application				Contactors for Motors
Subrange				Contactors up to 170 A, 3 pole
Utilization category				AC-1: Non-inductive or slightly inductive loads, resistance furnaces NAC-3: Normal AC induction motors: starting, switch off during running AC-4: Normal AC induction motors: starting, plugging, reversing, inching
				
Notes				Also suitable for motors with efficiency class IE3. IE3-ready devices are identified by the logo on their packaging.
Connection technique				Screw terminals
Number of poles				3 pole
Rated operational current				
AC-3				
Notes				At maximum permissible ambient temperature (open.)
380 V 400 V	I_e	A		95
AC-1				
Conventional free air thermal current, 3 pole, 50 - 60 Hz				
Open				
at 40 °C	$I_{th} = I_e$	A		130
enclosed	I_{th}	A		100
Conventional free air thermal current, 1 pole				
open	I_{th}	A		275
enclosed	I_{th}	A		250
Max. rating for three-phase motors, 50 - 60 Hz				
AC-3				
220 V 230 V	P	kW		30
380 V 400 V	P	kW		45
660 V 690 V	P	kW		75
AC-4				
220 V 230 V	P	kW		16
380 V 400 V	P	kW		26
660 V 690 V	P	kW		35
Contact sequence				
Instructions				Contacts to EN 50 012.
Can be combined with auxiliary contact				DILM150-XHI(V).. DILM1000-XHI(V)..
Actuating voltage				400 V 50 Hz, 440 V 60 Hz
Voltage AC/DC				AC operation
Connection to SmartWire-DT				no

Technical data

General

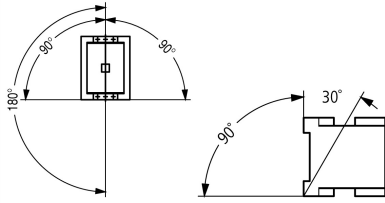
Standards			IEC/EN 60947, VDE 0660, UL, CSA
Lifespan, mechanical			
AC operated	Operations	$\times 10^6$	10
Operating frequency, mechanical			
AC operated	Operations/h		3600
Climatic proofing			Damp heat, constant, to IEC 60068-2-78 Damp heat, cyclic, to IEC 60068-2-30
Ambient temperature			
Open		°C	-25 - +60
Enclosed		°C	-25 - 40
Storage		°C	-40 - 80
Mounting position			
Mechanical shock resistance (IEC/EN 60068-2-27)			
Half-sinusoidal shock, 10 ms			
Main contacts			
N/O contact		g	10
Auxiliary contacts			
N/O contact		g	7
N/C contact		g	5
Mechanical shock resistance (IEC/EN 60068-2-27) when tabletop-mounted			
Half-sinusoidal shock, 10 ms			
Main contacts			
N/O contact		g	10
Auxiliary contacts			
N/O contact		g	7
N/C contact		g	5
Degree of Protection			IP00
Protection against direct contact when actuated from front (EN 50274)			Finger and back-of-hand proof
Altitude		m	Max. 2000
Weight			
AC operated		kg	2.18
Screw connector terminals			
Terminal capacity main cable			
Flexible with ferrule		mm ²	1 x (10 - 70) 2 x (10 - 50)
Stranded		mm ²	1 x (16 - 70) 2 x (16 - 50)
Solid or stranded		AWG	single 8...3/0, double 8...2/0
Flat conductor	Lamellenzahl x Breite x Dicke	mm	2 x (6 x 16 x 0.8)
Stripping length		mm	24
Terminal screw			M10
Tightening torque		Nm	14
Tool			
Hexagon socket-head spanner	SW	mm	5
Terminal capacity control circuit cables			
Solid		mm ²	1 x (0.75 - 4) 2 x (0.75 - 2.5)
Flexible with ferrule		mm ²	1 x (0.75 - 2.5) 2 x (0.75 - 2.5)

Solid or stranded		AWG	18 - 14
Stripping length		mm	10
Terminal screw			M3.5
Tightening torque		Nm	1.2
Tool			
Pozidriv screwdriver		Size	2
Standard screwdriver		mm	0.8 x 5.5 1 x 6

Main conducting paths

Rated impulse withstand voltage	U_{imp}	V AC	8000
Overvoltage category/pollution degree			III/3
Rated insulation voltage	U_i	V AC	690
Rated operational voltage	U_e	V AC	690
Safe isolation to EN 61140			
between coil and contacts		V AC	690
between the contacts		V AC	690
Making capacity (p.f. to IEC/EN 60947)			
	Up to 690 V	A	1330
Breaking capacity			
220 V 230 V		A	950
380 V 400 V		A	950
500 V		A	950
660 V 690 V		A	800
Short-circuit rating			
Short-circuit protection maximum fuse			
Type "2" coordination			
400 V	gG/gL 500 V	A	160
690 V	gG/gL 690 V	A	160
Type "1" coordination			
400 V	gG/gL 500 V	A	250
690 V	gG/gL 690 V	A	200

AC

AC-1			
Rated operational current			
Conventional free air thermal current, 3 pole, 50 - 60 Hz			
Open			
at 40 °C	$I_{th} = I_e$	A	130
at 50 °C	$I_{th} = I_e$	A	125
at 55 °C	$I_{th} = I_e$	A	115
at 60 °C	$I_{th} = I_e$	A	110
enclosed	I_{th}	A	100
Conventional free air thermal current, 1 pole			
open	I_{th}	A	275
enclosed	I_{th}	A	250
AC-3			
Rated operational current			
Open, 3-pole: 50 – 60 Hz			
Notes			At maximum permissible ambient temperature (open.)
220 V 230 V	I_e	A	95
240 V	I_e	A	95
380 V 400 V	I_e	A	95
415 V	I_e	A	95
440V	I_e	A	95
500 V	I_e	A	95
660 V 690 V	I_e	A	80

380 V 400 V	I_e	A	95
Motor rating	P	kWh	
220 V 230 V	P	kW	30
240V	P	kW	32
380 V 400 V	P	kW	45
415 V	P	kW	57
440 V	P	kW	60
500 V	P	kW	70
660 V 690 V	P	kW	75
AC-4			
Open, 3-pole: 50 – 60 Hz			
220 V 230 V	I_e	A	50
240 V	I_e	A	50
380 V 400 V	I_e	A	50
415 V	I_e	A	50
440 V	I_e	A	50
500 V	I_e	A	50
660 V 690 V	I_e	A	37
Motor rating	P	kWh	
220 V 230 V	P	kW	16
240 V	P	kW	17
380 V 400 V	P	kW	26
415 V	P	kW	30
440 V	P	kW	32
500 V	P	kW	36
660 V 690 V	P	kW	35

DC

Rated operational current, open			
DC-1			
60 V	I_e	A	110
110 V	I_e	A	110
220 V	I_e	A	70

Current heat loss

3 pole, at I_{th} (60°)		W	16.9
Current heat loss at I_e to AC-3/400 V		W	12.6
Impedance per pole		mΩ	0.6

Magnet systems

Voltage tolerance			
AC operated	Pick-up	$x U_c$	0.8 - 1.1
Drop-out voltage AC operated	Drop-out	$x U_c$	0.3 - 0.6
Power consumption of the coil in a cold state and $1.0 \times U_S$			
50 Hz	Pick-up	VA	310
50 Hz	Sealing	VA	26
50 Hz	Sealing	W	5.8
60 Hz	Pick-up	VA	345
60 Hz	Sealing	VA	30
60 Hz	Sealing	W	5.8
Duty factor		% DF	100
Changeover time at 100 % U_S (recommended value)			
Main contacts			
AC operated			
Closing delay		ms	14 - 20
Opening delay		ms	9 - 14
Arcing time		ms	15

Permissible residual current with actuation of A1 - A2 by the electronics (with 0 signal).		mA	≤ 1
Electromagnetic compatibility (EMC)			
Emitted interference			to EN 60947-1
Interference immunity			to EN 60947-1
Rating data for approved types			
Switching capacity			
Maximum motor rating			
Three-phase			
200 V 208 V		HP	30
230 V 240 V		HP	40
460 V 480 V		HP	75
575 V 600 V		HP	100
Single-phase			
115 V 120 V		HP	7.5
230 V 240 V		HP	15
General use		A	125
Short Circuit Current Rating			
Basic Rating			
SCCR		kA	10
max. Fuse		A	600
max. CB		A	600
480 V High Fault			
SCCR (fuse)		kA	30/100
max. Fuse		A	300/300 Class J
SCCR (CB)		kA	65
max. CB		A	250
600 V High Fault			
SCCR (fuse)		kA	30/100
max. Fuse		A	300/300 Class J
SCCR (CB)		kA	30
max. CB		A	350
Special Purpose Ratings			
Electrical Discharge Lamps (Ballast)			
480V 60Hz 3phase, 277V 60Hz 1phase		A	100
600V 60Hz 3phase, 347V 60Hz 1phase		A	100
Incandescent Lamps (Tungsten)			
480V 60Hz 3phase, 277V 60Hz 1phase		A	100
600V 60Hz 3phase, 347V 60Hz 1phase		A	100
Resistance Air Heating			
480V 60Hz 3phase, 277V 60Hz 1phase		A	100
600V 60Hz 3phase, 347V 60Hz 1phase		A	100
Refrigeration Control (CSA only)			
LRA 480V 60Hz 3phase		A	540
FLA 480V 60Hz 3phase		A	90
LRA 600V 60Hz 3phase		A	420
FLA 600V 60Hz 3phase		A	70
Definite Purpose Ratings (100,000 cycles acc. to UL 1995)			
LRA 480V 60Hz 3phase		A	570
FLA 480V 60Hz 3phase		A	95
Elevator Control			
200V 60Hz 3phase		HP	20
200V 60Hz 3phase		A	62.1

240V 60Hz 3phase	HP	30
240V 60Hz 3phase	A	80
480V 60Hz 3phase	HP	60
480V 60Hz 3phase	A	77
600V 60Hz 3phase	HP	75
600V 60Hz 3phase	A	77

Design verification as per IEC/EN 61439

Technical data for design verification			
Rated operational current for specified heat dissipation	I_n	A	95
Heat dissipation per pole, current-dependent	P_{vid}	W	4.2
Equipment heat dissipation, current-dependent	P_{vid}	W	12.6
Static heat dissipation, non-current-dependent	P_{vs}	W	5.8
Heat dissipation capacity	P_{diss}	W	0
Operating ambient temperature min.		°C	-25
Operating ambient temperature max.		°C	60
IEC/EN 61439 design verification			
10.2 Strength of materials and parts			
10.2.2 Corrosion resistance			Meets the product standard's requirements.
10.2.3.1 Verification of thermal stability of enclosures			Meets the product standard's requirements.
10.2.3.2 Verification of resistance of insulating materials to normal heat			Meets the product standard's requirements.
10.2.3.3 Verification of resistance of insulating materials to abnormal heat and fire due to internal electric effects			Meets the product standard's requirements.
10.2.4 Resistance to ultra-violet (UV) radiation			Meets the product standard's requirements.
10.2.5 Lifting			Does not apply, since the entire switchgear needs to be evaluated.
10.2.6 Mechanical impact			Does not apply, since the entire switchgear needs to be evaluated.
10.2.7 Inscriptions			Meets the product standard's requirements.
10.3 Degree of protection of ASSEMBLIES			Does not apply, since the entire switchgear needs to be evaluated.
10.4 Clearances and creepage distances			Meets the product standard's requirements.
10.5 Protection against electric shock			Does not apply, since the entire switchgear needs to be evaluated.
10.6 Incorporation of switching devices and components			Does not apply, since the entire switchgear needs to be evaluated.
10.7 Internal electrical circuits and connections			Is the panel builder's responsibility.
10.8 Connections for external conductors			Is the panel builder's responsibility.
10.9 Insulation properties			
10.9.2 Power-frequency electric strength			Is the panel builder's responsibility.
10.9.3 Impulse withstand voltage			Is the panel builder's responsibility.
10.9.4 Testing of enclosures made of insulating material			Is the panel builder's responsibility.
10.10 Temperature rise			The panel builder is responsible for the temperature rise calculation. Eaton will provide heat dissipation data for the devices.
10.11 Short-circuit rating			Is the panel builder's responsibility. The specifications for the switchgear must be observed.
10.12 Electromagnetic compatibility			Is the panel builder's responsibility. The specifications for the switchgear must be observed.
10.13 Mechanical function			The device meets the requirements, provided the information in the instruction leaflet (IL) is observed.

Technical data ETIM 7.0

Low-voltage industrial components (EG000017) / Power contactor, AC switching (EC000066)			
Electric engineering, automation, process control engineering / Low-voltage switch technology / Contactor (LV) / Power contactor, AC switching (ecl@ss10.0.1-27-37-10-03 [AAB718015])			
Rated control supply voltage U_s at AC 50HZ	V		400 - 400
Rated control supply voltage U_s at AC 60HZ	V		440 - 440
Rated control supply voltage U_s at DC	V		0 - 0
Voltage type for actuating			AC
Rated operation current I_e at AC-1, 400 V	A		130
Rated operation current I_e at AC-3, 400 V	A		95
Rated operation power at AC-3, 400 V	kW		45
Rated operation current I_e at AC-4, 400 V	A		50

Rated operation power at AC-4, 400 V		kW	26
Rated operation power NEMA		kW	55
Modular version			No
Number of auxiliary contacts as normally open contact			0
Number of auxiliary contacts as normally closed contact			0
Type of electrical connection of main circuit			Screw connection
Number of normally closed contacts as main contact			0
Number of main contacts as normally open contact			3

Approvals

Product Standards			IEC/EN 60947-4-1; UL 60947-4-1; CSA - C22.2 No. 60947-4-1-14; CE marking
UL File No.			E29096
UL Category Control No.			NLDX
CSA File No.			012528
CSA Class No.			2411-03, 3211-04
North America Certification			UL listed, CSA certified
Specially designed for North America			No

Characteristics



- 1: Overload relay
- 2: Suppressor
- 3: Auxiliary contact modules

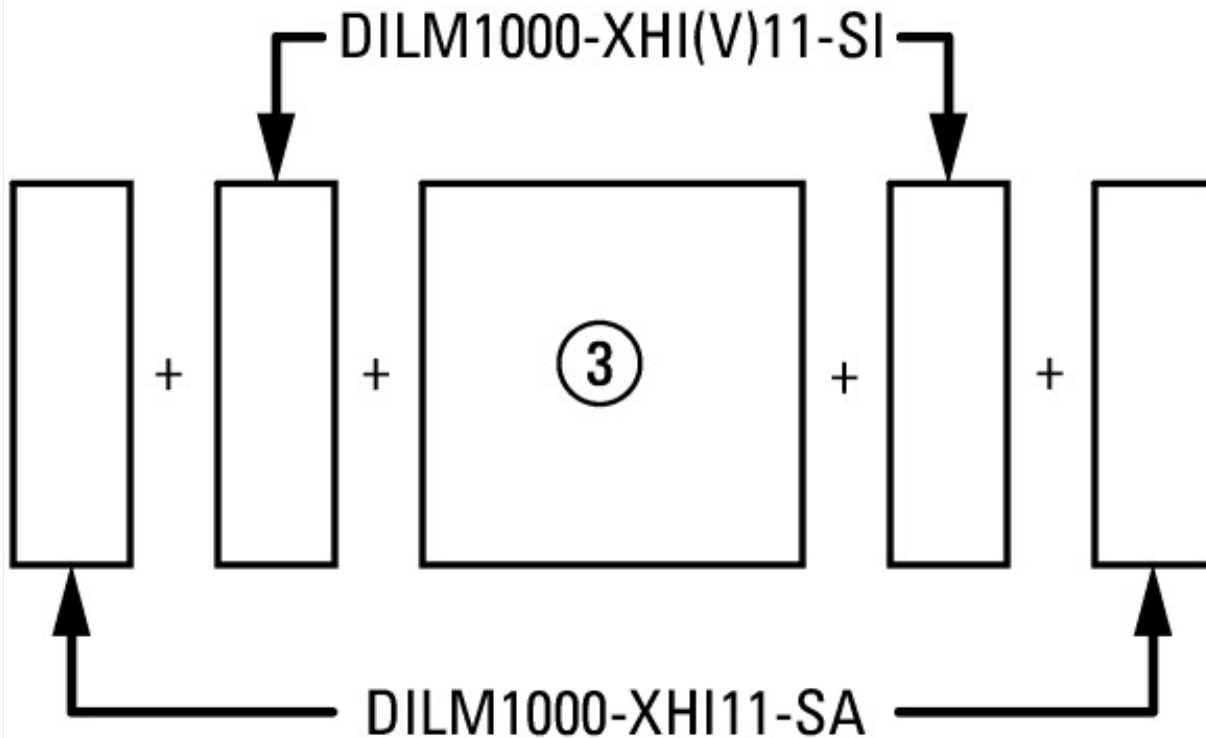

on the side: 2 x DILM820-XHI11(V)-SI; 2 x DILM820-XHI11-SA

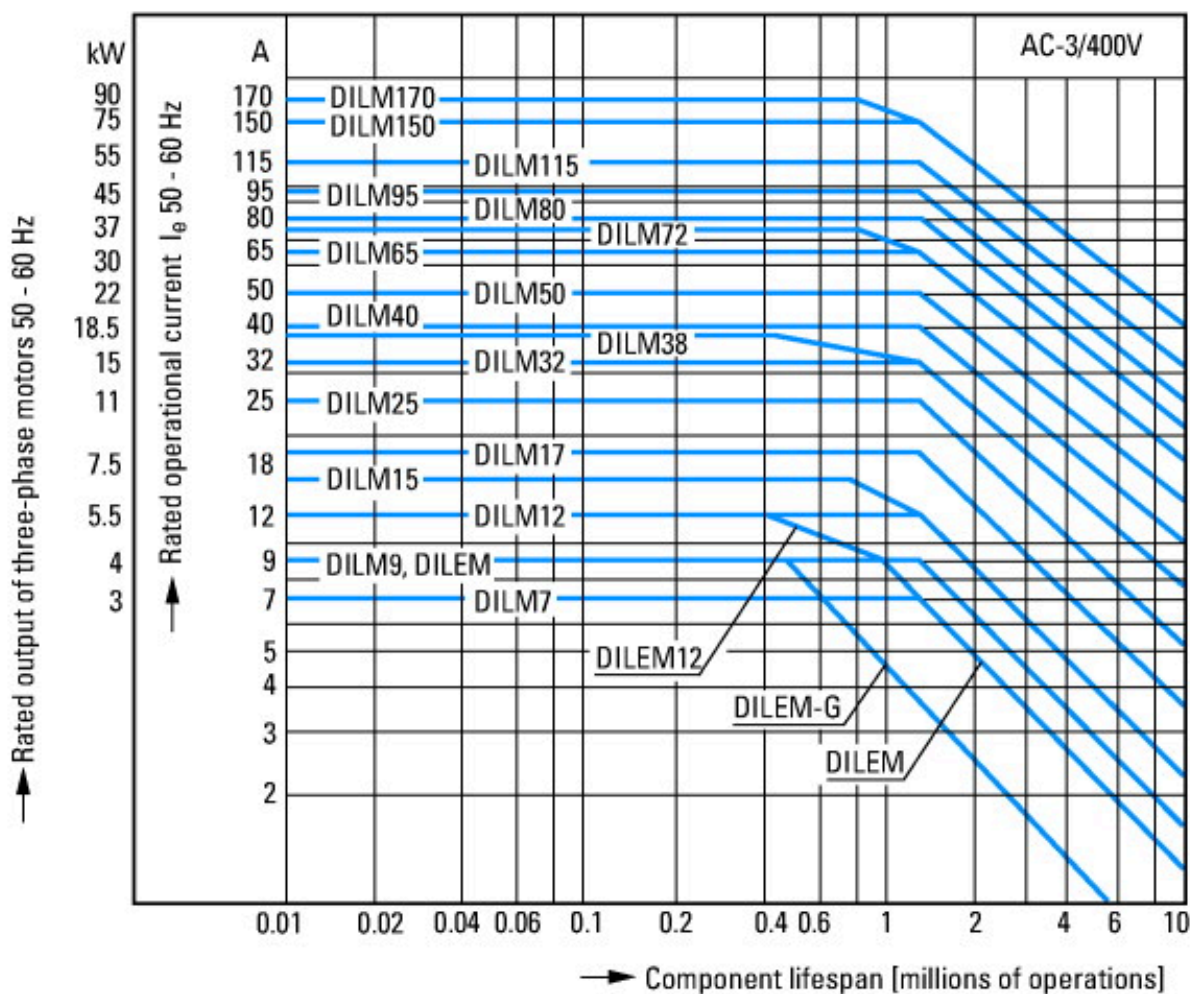

Squirrel-cage motor
 Operating characteristics
 Starting: from rest
 Stopping: after attaining full running speed
 Electrical characteristics
 Make: up to 6 x rated motor current
 Break: up to 1 x rated motor current
 Utilization category
 100 % AC-3
 Typical applications

- Compressors
- Lifts
- Mixers
- Pumps
- Escalators
- Agitators
- Fans
- Conveyor belts
- Centrifuges
- Hinged flaps
- Bucket-elevators
- Air conditioning system
- General drives in manufacturing and processing machines

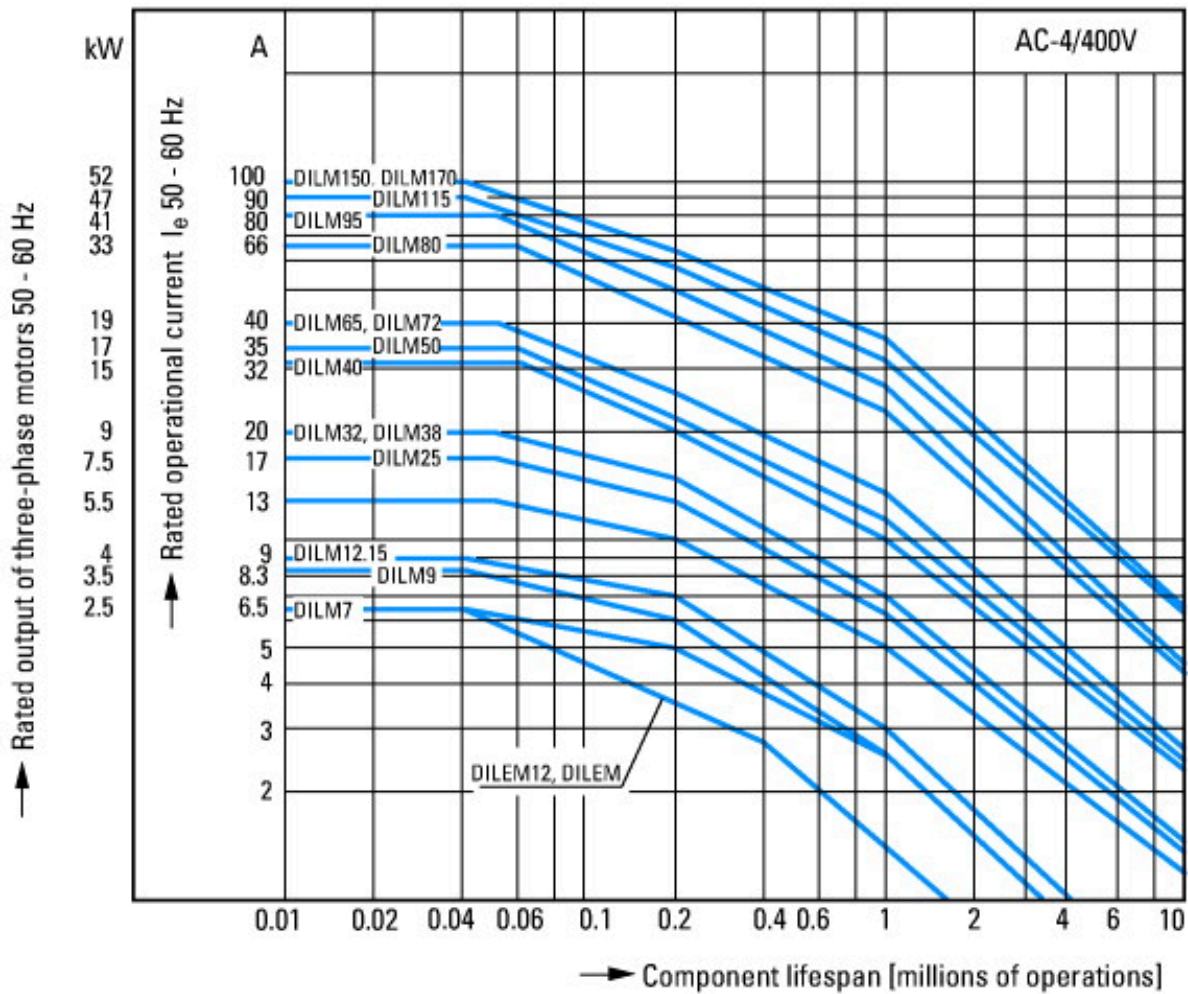

- Extreme switching duty
- Squirrel-cage motor
- Operating characteristics
- Inching, plugging, reversing
- Electrical characteristics
- Make: up to 6 x rated motor current
- Break: up to 6 x rated motor current
- Utilization category
- 100 % AC-4
- Typical applications
- Printing presses
- Wire-drawing machines
- Centrifuges
- Special drives for manufacturing and processing machines



Switching conditions for non-motor consumers, 3 pole, 4 pole
 Operating characteristics
 Non inductive and slightly inductive loads
 Electrical characteristics
 Switch on: 1 x rated operational current
 Switch off: 1 x rated operational current
 Utilization category
 100 % AC-1
 Typical examples of application
 Electric heat

Dimensions

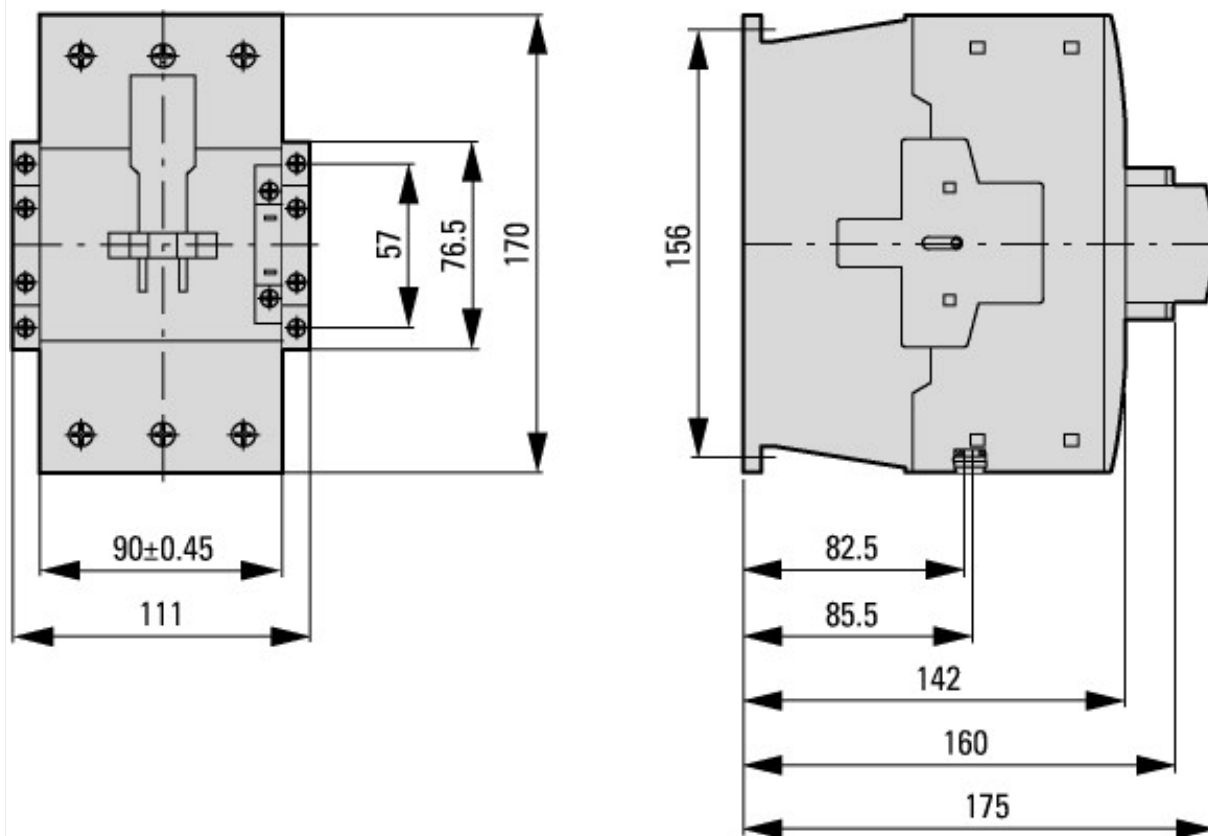

Contacteur with auxiliary contact module

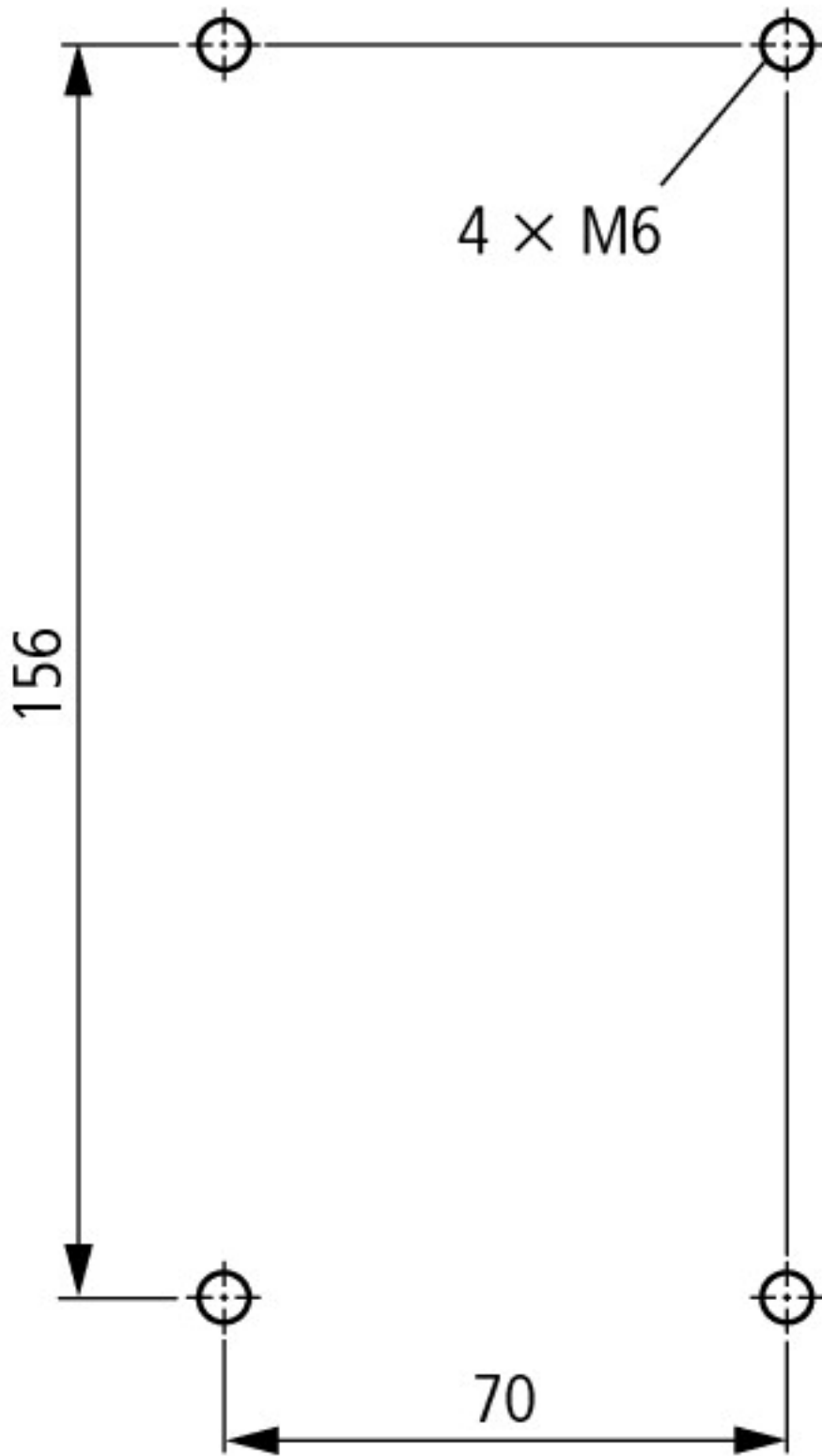

distance at side to earthed parts: 10 mm

DILM80...DILM170
DILMC80...DILMC150
DILMF80...DILMF150



SCATTERGOOD & JOHNSON LTD

ELECTRICAL ENGINEERING & FLUID CONTROL DISTRIBUTORS

Est.1899

At Scattergood & Johnson Ltd, we pride ourselves on being a technical distributor to specialist industries.

Working with a range of quality product suppliers across a number of specialist markets, we are not your average 'box shifter' - we are your technical and supply chain partner.

We fully support every product we sell - for free! Our internal team and external sales engineers can answer any product or application question, no matter the complexity.

Backing up this technical ability is a range of 50,000+ products available from stock for nationwide next day delivery (same day if required!), or you can collect what you need from any of our trade counters around the UK.

Select your specialist interest below to learn more about how we can help.



Online, In Branch and On the Road - Scattergood & Johnson Ltd, there when you need us.

www.scatts.co.uk