

**DATASHEET - DILM400/22(RAC500)**



**Contactors, 380 V 400 V 212 kW, 2 N/O, 2 NC, RAC 500: 250 - 500 V 40 - 60 Hz/250 - 700 V DC, AC and DC operation, Screw connection**

**Part no. DILM400/22(RAC500)**  
**Catalog No. 208210**  
**Alternate Catalog No. XTCE400M22C**

**Delivery program**

Product range				Contactors
Application				Contactors for Motors
Subrange				Comfort devices greater than 170 A
Utilization category				AC-1: Non-inductive or slightly inductive loads, resistance furnaces NAC-3: Normal AC induction motors: starting, switch off during running AC-4: Normal AC induction motors: starting, plugging, reversing, inching
Connection technique				Screw connection
<b>Rated operational current</b>				
AC-3				
380 V 400 V	$I_e$	A		400
AC-1				
Conventional free air thermal current, 3 pole, 50 - 60 Hz				
Open				
at 40 °C	$I_{th} = I_e$	A		612
enclosed	$I_{th}$	A		450
Conventional free air thermal current, 1 pole				
open	$I_{th}$	A		1250
enclosed	$I_{th}$	A		1125
<b>Max. rating for three-phase motors, 50 - 60 Hz</b>				
AC-3				
220 V 230 V	P	kW		125
380 V 400 V	P	kW		212
660 V 690 V	P	kW		300
1000 V	P	kW		132
AC-4				
220 V 230 V	P	kW		92
380 V 400 V	P	kW		160
660 V 690 V	P	kW		240
1000 V	P	kW		132
Contact sequence				
Can be combined with auxiliary contact				DILM820-XHI...
Actuating voltage				RAC 500: 250 - 500 V 40 - 60 Hz/250 - 700 V DC
Voltage AC/DC				AC and DC operation
<b>Contacts</b>				
N/O = Normally open				2 N/O
N/C = Normally closed				2 NC
<b>Auxiliary contacts</b>				
possible variants at auxiliary contact module fitting options				on the side: 2 x DILM820-XHI11(V)-SI; 2 x DILM820-XHI11-SA
Side mounting auxiliary contacts				
<b>Instructions</b>				Interlocked opposing contacts according to IEC/EN 60947-5-1 Appendix L, inside the auxiliary contact module

**Instructions**integrated suppressor circuit in actuating electronics  
660 V, 690 V or 1000 V: not directly reversing**Technical data****General**

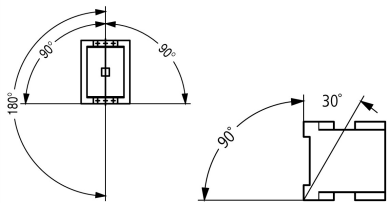
Standards			IEC/EN 60947, VDE 0660, UL, CSA
Lifespan, mechanical			
AC operated	Operations	$\times 10^6$	7
DC operated	Operations	$\times 10^6$	7
Operating frequency, mechanical			
AC operated	Operations/h		2000
DC operated	Operations/h		2000
Climatic proofing			Damp heat, constant, to IEC 60068-2-78 Damp heat, cyclic, to IEC 60068-2-30
Ambient temperature			
Open		°C	-40 - +60
Enclosed		°C	- 40 - + 40
Storage		°C	- 40 - + 80
Mounting position			
Mechanical shock resistance (IEC/EN 60068-2-27)			
Half-sinusoidal shock, 10 ms			
Main contacts			
N/O contact		g	10
Auxiliary contacts			
N/O contact		g	10
N/C contact		g	8
Degree of Protection			IP00
Protection against direct contact when actuated from front (EN 50274)			Finger and back-of-hand proof with terminal shroud or terminal block
Altitude		m	Max. 2000
Weight			
AC operated		kg	8.6
DC operated		kg	8.6
Weight		kg	8.6
Terminal capacity main cable			
Flexible with cable lug		mm <sup>2</sup>	50 - 240
Stranded with cable lug		mm <sup>2</sup>	70 - 240
Solid or stranded		AWG	2/0 - 500 MCM
Flat conductor	Lamellenzahl x Breite x Dicke	mm	Fixing with flat cable terminal or cable terminal blocks See terminal capacity for cable terminal blocks
Busbar	Width	mm	25
Main cable connection screw/bolt			M10
Tightening torque		Nm	24
Terminal capacity control circuit cables			
Solid		mm <sup>2</sup>	1 x (0.75 - 2.5) 2 x (0.75 - 2.5)
Flexible with ferrule		mm <sup>2</sup>	1 x (0.75 - 2.5) 2 x (0.75 - 2.5)
Solid or stranded		AWG	18 - 14
Control circuit cable connection screw/bolt			M3.5
Tightening torque		Nm	1.2

Tool			
Main cable			
Width across flats	mm		16
Control circuit cables			
Pozidriv screwdriver	Size		2

### Main conducting paths

Rated impulse withstand voltage	$U_{imp}$	V AC	8000
Overvoltage category/pollution degree			III/3
Rated insulation voltage	$U_i$	V AC	1000
Rated operational voltage	$U_e$	V AC	1000
Safe isolation to EN 61140			
between coil and contacts		V AC	500
between the contacts		V AC	500
Making capacity (p.f. to IEC/EN 60947)		A	5500
Breaking capacity			
220 V 230 V		A	5000
380 V 400 V		A	5000
500 V		A	5000
660 V 690 V		A	5000
1000 V		A	950
Component lifespan			
			AC1: See → Engineering, characteristic curves AC3: See → Engineering, characteristic curves AC4: See → Engineering, characteristic curves
Short-circuit rating			
Short-circuit protection maximum fuse			
Type "2" coordination			
400 V	gG/gL 500 V	A	500
690 V	gG/gL 690 V	A	500
1000 V	gG/gL 1000 V	A	200
Type "1" coordination			
400 V	gG/gL 500 V	A	630
690 V	gG/gL 690 V	A	630
1000 V	gG/gL 1000 V	A	250

### AC

AC-1			
Rated operational current			
Conventional free air thermal current, 3 pole, 50 - 60 Hz			
Open			
at 40 °C	$I_{th} = I_e$	A	612
at 50 °C	$I_{th} = I_e$	A	548
at 55 °C	$I_{th} = I_e$	A	522
at 60 °C	$I_{th} = I_e$	A	500
enclosed	$I_{th}$	A	450
Notes			At maximum permissible ambient air temperature.
Conventional free air thermal current, 1 pole			
Note			at maximum permissible ambient air temperature
open	$I_{th}$	A	1250
enclosed	$I_{th}$	A	1125
AC-3			
Rated operational current			
Open, 3-pole: 50 – 60 Hz			
Notes			At maximum permissible ambient temperature (open.)
220 V 230 V	$I_e$	A	400
240 V	$I_e$	A	400

380 V 400 V	I <sub>e</sub>	A	400
415 V	I <sub>e</sub>	A	400
440V	I <sub>e</sub>	A	400
500 V	I <sub>e</sub>	A	400
660 V 690 V	I <sub>e</sub>	A	325
1000 V	I <sub>e</sub>	A	95
Motor rating	P	kWh	
220 V 230 V	P	kW	125
240V	P	kW	132
380 V 400 V	P	kW	212
415 V	P	kW	232
440 V	P	kW	250
500 V	P	kW	280
660 V 690 V	P	kW	300
1000 V	P	kW	132
<b>AC-4</b>			
Rated operational current			
Open, 3-pole: 50 – 60 Hz			
220 V 230 V	I <sub>e</sub>	A	296
240 V	I <sub>e</sub>	A	296
380 V 400 V	I <sub>e</sub>	A	296
415 V	I <sub>e</sub>	A	296
440 V	I <sub>e</sub>	A	296
500 V	I <sub>e</sub>	A	296
660 V 690 V	I <sub>e</sub>	A	260
1000 V	I <sub>e</sub>	A	95
Motor rating	P	kWh	
220 V 230 V	P	kW	92
240 V	P	kW	100
380 V 400 V	P	kW	160
415 V	P	kW	176
440 V	P	kW	186
500 V	P	kW	210
660 V 690 V	P	kW	240
1000 V	P	kW	132

**Condensator operation**

Individual compensation, rated operational current I <sub>e</sub> of three-phase capacitors			
Open			
up to 525 V		A	307
690 V		A	177
Max. inrush current peak		x I <sub>e</sub>	30
Component lifespan	Operations	x 10 <sup>6</sup>	0.1
Max. operating frequency		Ops/h	200

**DC**

Rated operational current, open			
DC-1			
Notes			see D1LDC300/D1LDC600 or on request

**Current heat loss**

3 pole, at I <sub>th</sub> (60°)		W	58
Current heat loss at I <sub>e</sub> to AC-3/400 V		W	37

**Magnet systems**

Voltage tolerance			
U <sub>S</sub>			250 - 500 V 40-60 Hz 250 - 700 V DC
AC operated	Pick-up		0.7 x U <sub>S min</sub> - 1.15 x U <sub>S max</sub>

DC operated	Pick-up		$0.7 \times U_{S \min} - 1.15 \times U_{S \max}$
AC operated	Drop-out		$0.2 \times U_{S \max} - 0.6 \times U_{S \min}$
DC operated	Drop-out		$0.2 \times U_{S \max} - 0.6 \times U_{S \min}$
Power consumption of the coil in a cold state and $1.0 \times U_S$			
Note on power consumption			Control transformer with $u_k \leq 6\%$
Pull-in power	Pick-up	VA	450
Pull-in power	Pick-up	W	350
Sealing power	Sealing	VA	19.6
Sealing power	Sealing	W	11.7
Duty factor		% DF	100
Changeover time at 100 % $U_S$ (recommended value)			
Main contacts			
Closing delay		ms	80
Opening delay		ms	110
Behaviour in marginal and transitional conditions			
Sealing			
Voltage interruptions			
$(0 \dots 0.2 \times U_{C \min}) \leq 10 \text{ ms}$			Time is bridged successfully
$(0 \dots 0.2 \times U_{C \min}) > 10 \text{ ms}$			Drop-out of the contactor
Voltage drops			
$(0.2 \dots 0.6 \times U_{C \min}) \leq 12 \text{ ms}$			Time is bridged successfully
$(0.2 \dots 0.6 \times U_{C \min}) > 12 \text{ ms}$			Drop-out of the contactor
$(0.6 \dots 0.7 \times U_{C \min})$			Contactor remains switched on
Excess voltage			
$(1.15 \dots 1.3 \times U_{C \max})$			Contactor remains switched on
Pick-up phase			
$(0 \dots 0.7 \times U_{C \min})$			Contactor does not switch on
$(0.7 \times U_{C \min} \dots 1.15 \times U_{C \max})$			Contactor switches on with certainty
Admissible transitional contact resistance (of the external control circuit device when actuating A11)		m $\Omega$	$\leq 500$
PLC signal level (A3 - A4) to IEC/EN 61131-2 (type 2)			
High		V	15
Low		V	5

### Electromagnetic compatibility (EMC)

Electromagnetic compatibility			This product is designed for operation in industrial environments (environment A). Its use in residential environments (environment B) may cause radio-frequency interference, requiring additional noise suppression measures.
-------------------------------	--	--	---

### Rating data for approved types

Switching capacity			
Maximum motor rating			
Three-phase			
200 V 208 V		HP	125
230 V 240 V		HP	150
460 V 480 V		HP	300
575 V 600 V		HP	400
General use		A	450
Auxiliary contacts			
Pilot Duty			
AC operated			A600
DC operated			P300
General Use			
AC		V	600
AC		A	15

DC	V	250
DC	A	1
Short Circuit Current Rating	SCCR	
Basic Rating		
SCCR	kA	30
max. Fuse	A	800
max. CB	A	600
480 V High Fault		
SCCR (fuse)	kA	30/100
max. Fuse	A	800/600 Class J
SCCR (CB)	kA	100
max. CB	A	600
600 V High Fault		
SCCR (fuse)	kA	30/100
max. Fuse	A	800/600 Class J
SCCR (CB)	kA	30
max. CB	A	600
Special Purpose Ratings		
Definite Purpose Ratings (100,000 cycles acc. to UL 1995)		
LRA 480V 60Hz 3phase	A	3300
FLA 480V 60Hz 3phase	A	550
LRA 600V 60Hz 3phase	A	3120
FLA 600V 60Hz 3phase	A	420

## Design verification as per IEC/EN 61439

Technical data for design verification			
Rated operational current for specified heat dissipation	$I_n$	A	400
Heat dissipation per pole, current-dependent	$P_{vid}$	W	12.33
Equipment heat dissipation, current-dependent	$P_{vid}$	W	0
Static heat dissipation, non-current-dependent	$P_{vs}$	W	11.7
Heat dissipation capacity	$P_{diss}$	W	0
Operating ambient temperature min.		°C	-40
Operating ambient temperature max.		°C	60
IEC/EN 61439 design verification			
10.2 Strength of materials and parts			
10.2.2 Corrosion resistance			Meets the product standard's requirements.
10.2.3.1 Verification of thermal stability of enclosures			Meets the product standard's requirements.
10.2.3.2 Verification of resistance of insulating materials to normal heat			Meets the product standard's requirements.
10.2.3.3 Verification of resistance of insulating materials to abnormal heat and fire due to internal electric effects			Meets the product standard's requirements.
10.2.4 Resistance to ultra-violet (UV) radiation			Meets the product standard's requirements.
10.2.5 Lifting			Does not apply, since the entire switchgear needs to be evaluated.
10.2.6 Mechanical impact			Does not apply, since the entire switchgear needs to be evaluated.
10.2.7 Inscriptions			Meets the product standard's requirements.
10.3 Degree of protection of ASSEMBLIES			Does not apply, since the entire switchgear needs to be evaluated.
10.4 Clearances and creepage distances			Meets the product standard's requirements.
10.5 Protection against electric shock			Does not apply, since the entire switchgear needs to be evaluated.
10.6 Incorporation of switching devices and components			Does not apply, since the entire switchgear needs to be evaluated.
10.7 Internal electrical circuits and connections			Is the panel builder's responsibility.
10.8 Connections for external conductors			Is the panel builder's responsibility.
10.9 Insulation properties			
10.9.2 Power-frequency electric strength			Is the panel builder's responsibility.
10.9.3 Impulse withstand voltage			Is the panel builder's responsibility.
10.9.4 Testing of enclosures made of insulating material			Is the panel builder's responsibility.
10.10 Temperature rise			The panel builder is responsible for the temperature rise calculation. Eaton will provide heat dissipation data for the devices.

10.11 Short-circuit rating		Is the panel builder's responsibility. The specifications for the switchgear must be observed.
10.12 Electromagnetic compatibility		Is the panel builder's responsibility. The specifications for the switchgear must be observed.
10.13 Mechanical function		The device meets the requirements, provided the information in the instruction leaflet (IL) is observed.

## Technical data ETIM 7.0

Low-voltage industrial components (EG000017) / Power contactor, AC switching (EC000066)		
Electric engineering, automation, process control engineering / Low-voltage switch technology / Contactor (LV) / Power contactor, AC switching (ecl@ss10.0.1-27-37-10-03 [AAB718015])		
Rated control supply voltage Us at AC 50HZ	V	480 - 500
Rated control supply voltage Us at AC 60HZ	V	480 - 500
Rated control supply voltage Us at DC	V	0 - 0
Voltage type for actuating		AC
Rated operation current Ie at AC-1, 400 V	A	612
Rated operation current Ie at AC-3, 400 V	A	400
Rated operation power at AC-3, 400 V	kW	200
Rated operation current Ie at AC-4, 400 V	A	296
Rated operation power at AC-4, 400 V	kW	160
Rated operation power NEMA	kW	223
Modular version		No
Number of auxiliary contacts as normally open contact		2
Number of auxiliary contacts as normally closed contact		2
Type of electrical connection of main circuit		Rail connection
Number of normally closed contacts as main contact		0
Number of main contacts as normally open contact		3

## Approvals

Product Standards		IEC/EN 60947-4-1; UL 60947-4-1; CSA - C22.2 No. 60947-4-1-14; CE marking
UL File No.		E29096
UL Category Control No.		NLDX
CSA File No.		012528
CSA Class No.		3211-04
North America Certification		UL listed, CSA certified
Specially designed for North America		No

Characteristics

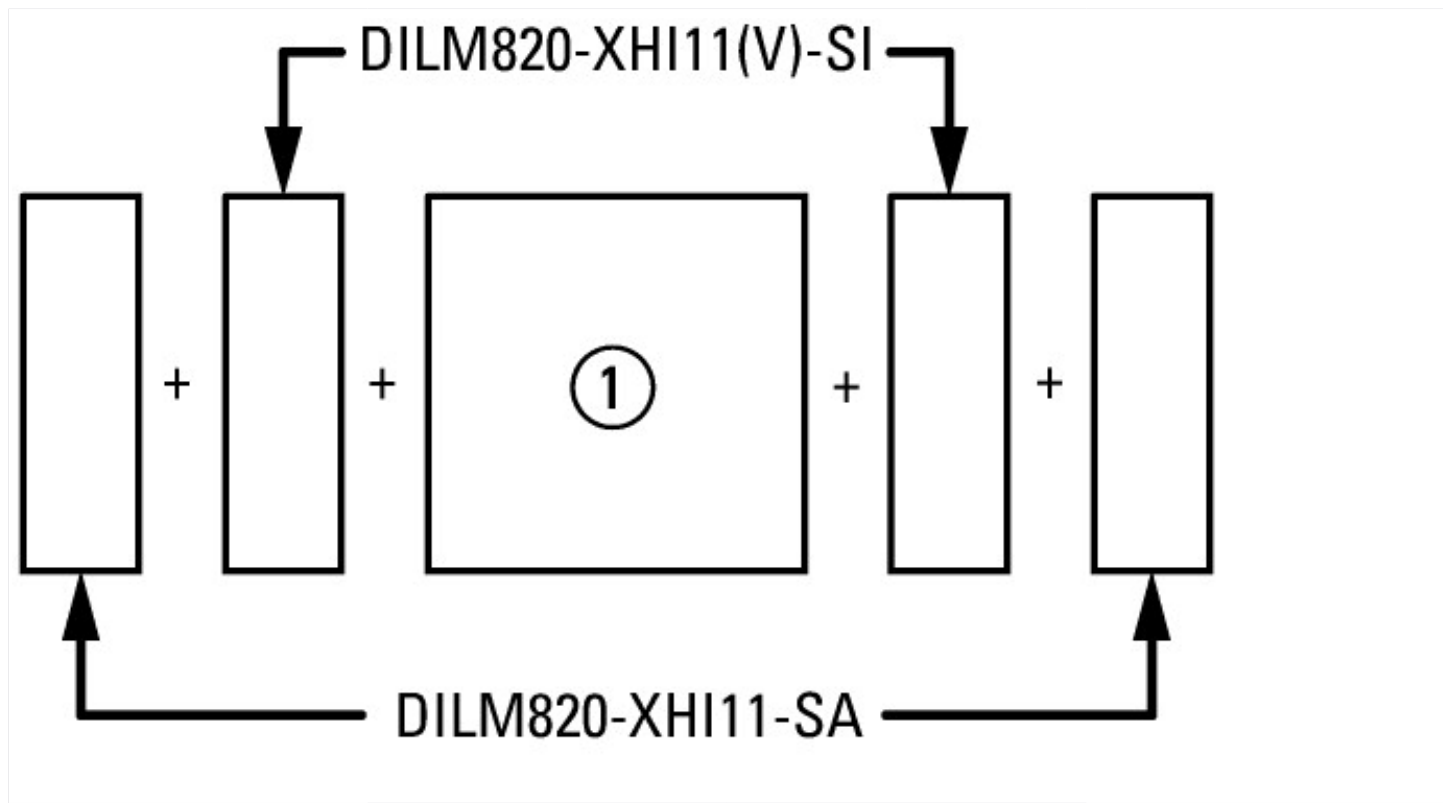

on the side: 2 x DILM820-XHI11(V)-SI; 2 x DILM820-XHI11-SA

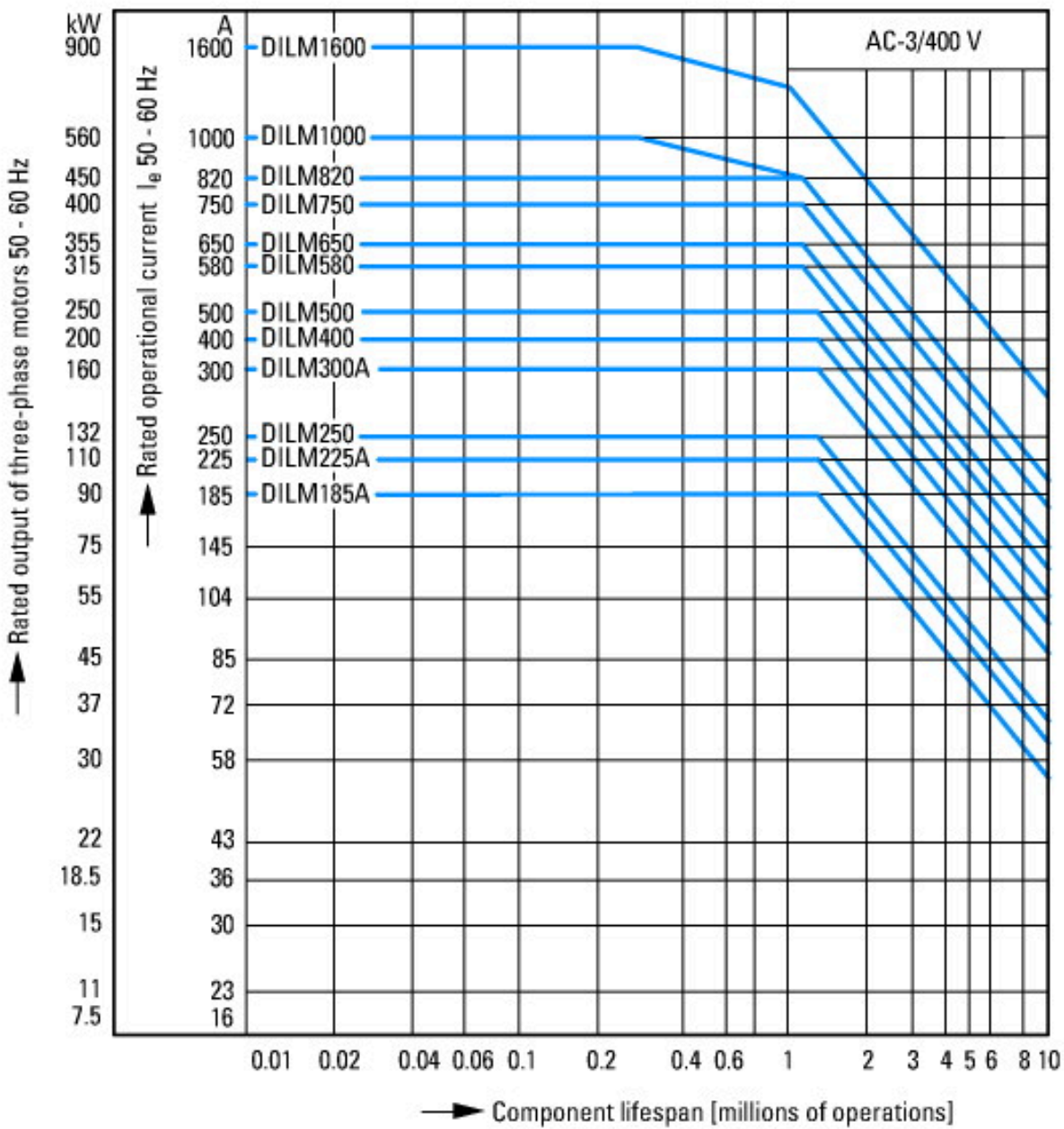

Normal switching duty  
 Normal AC induction motor  
 Operating characteristics  
 Switch on: from stop  
 Switch off: during run  
 Electrical characteristics:  
 Switch on: up to 6 x Rated motor current  
 Switch off: up to 1 x Rated motor current  
 Utility category  
 100 % AC-3  
 Typical Applications  
 Compressors  
 Lifts  
 Mixers  
 Pumps  
 Escalators  
 Agitators  
 fan  
 Conveyor belts  
 Centrifuges  
 Hinged flaps  
 Bucket-elevator  
 Air-conditioning systems  
 General drives for manufacturing and processing machines

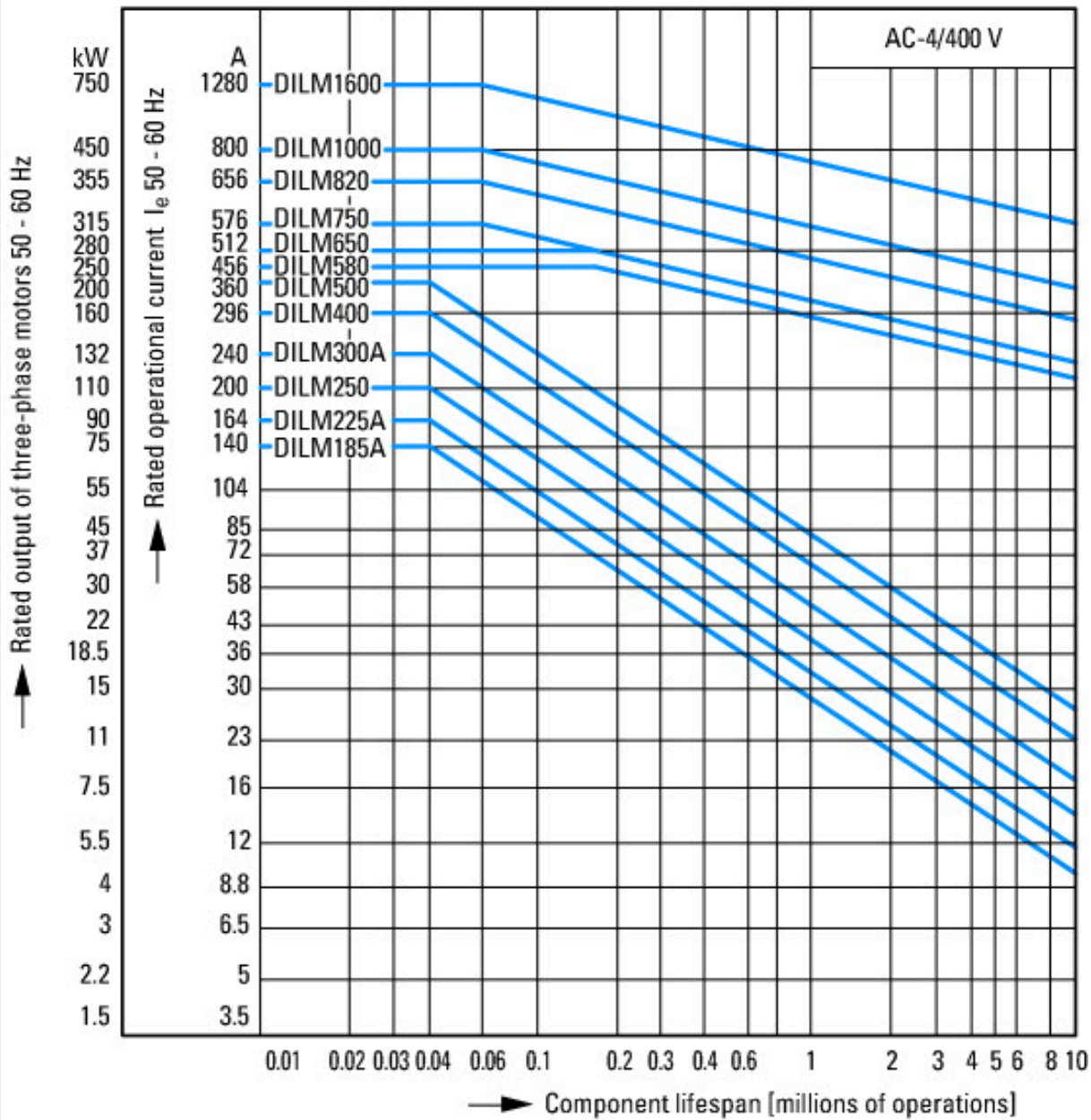

- Extreme switching duty
- Squirrel-cage motor
- Operating characteristics
- Inching, plugging, reversing
- Electrical characteristics
- Make: up to 6 x rated motor current
- Break: up to 6 x rated motor current
- Utilization category
- 100 % AC-4
- Typical applications
- Printing presses
- Wire-drawing machines
- Centrifuges
- Special drives for manufacturing and processing machines

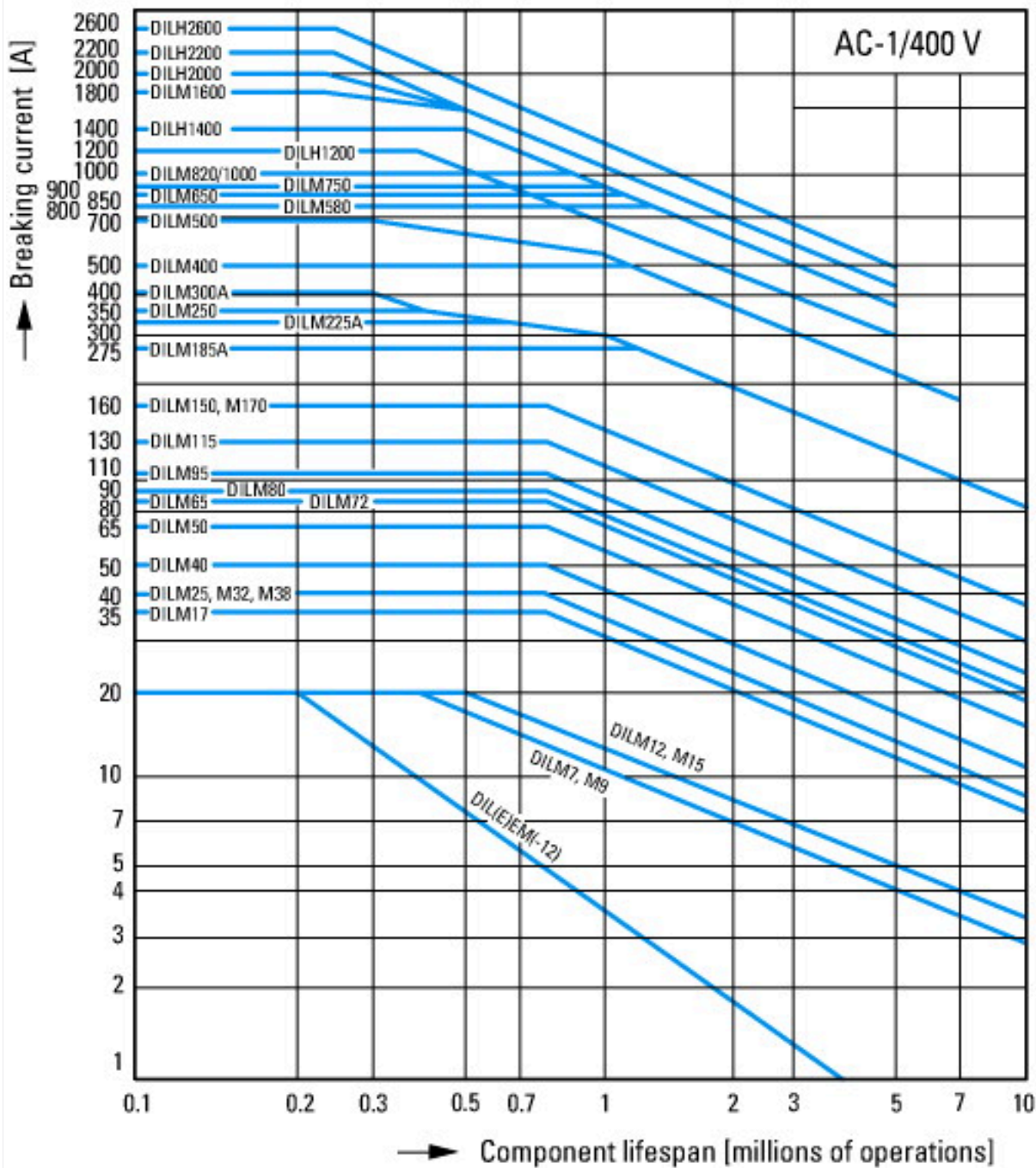

Switching conditions for 3 pole, non-motor loads  
 Operating characteristics  
 Non inductive and slightly inductive loads  
 Electrical characteristics  
 Switch on: 1 x rated operational current  
 Switch off: 1 x rated operational current  
 Utilization category  
 100 % AC-1  
 Typical examples of application  
 Electric heat

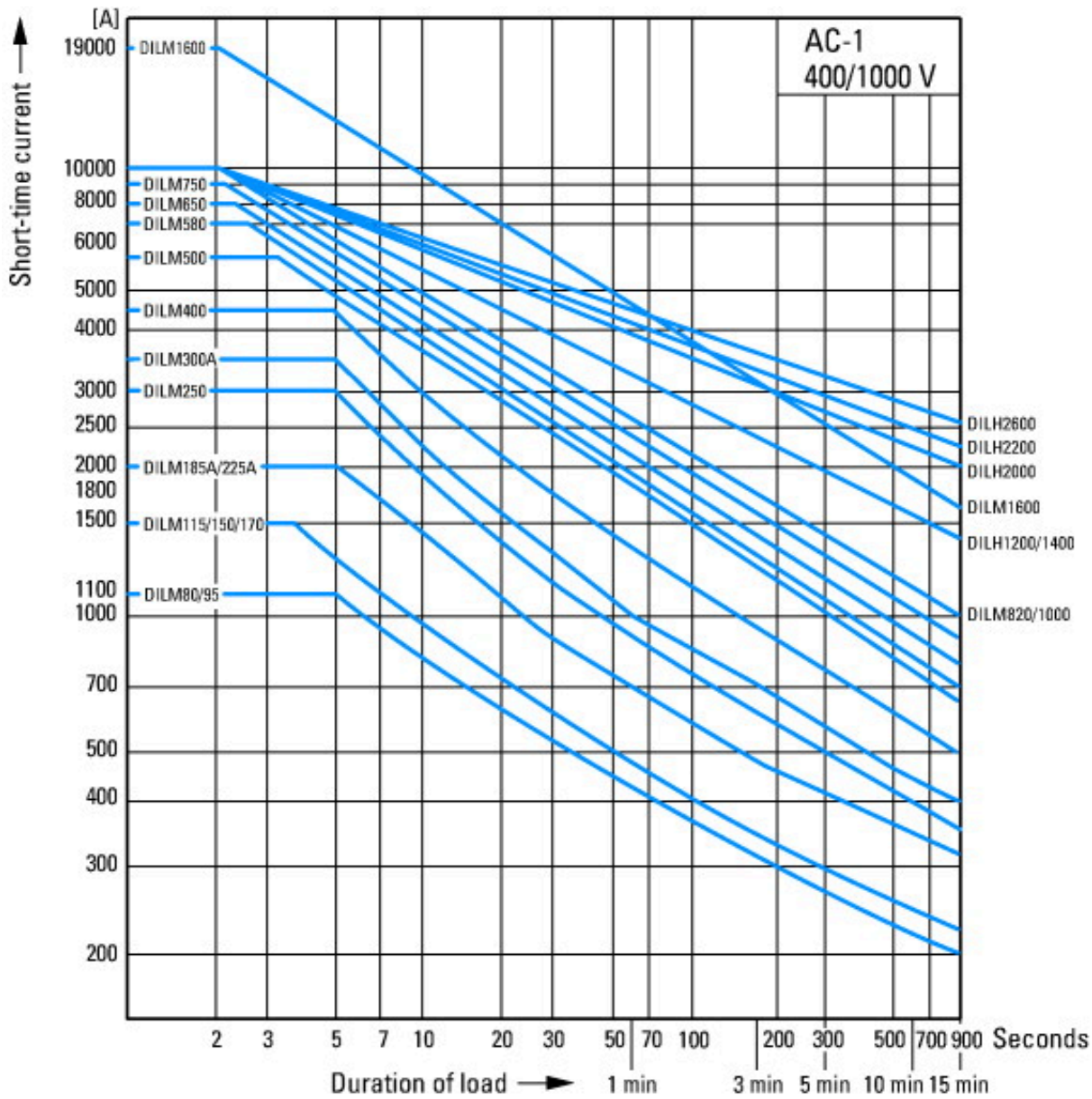

Short-time loading, 3-pole  
Time interval between two loading cycles: 15 minutes

### Dimensions

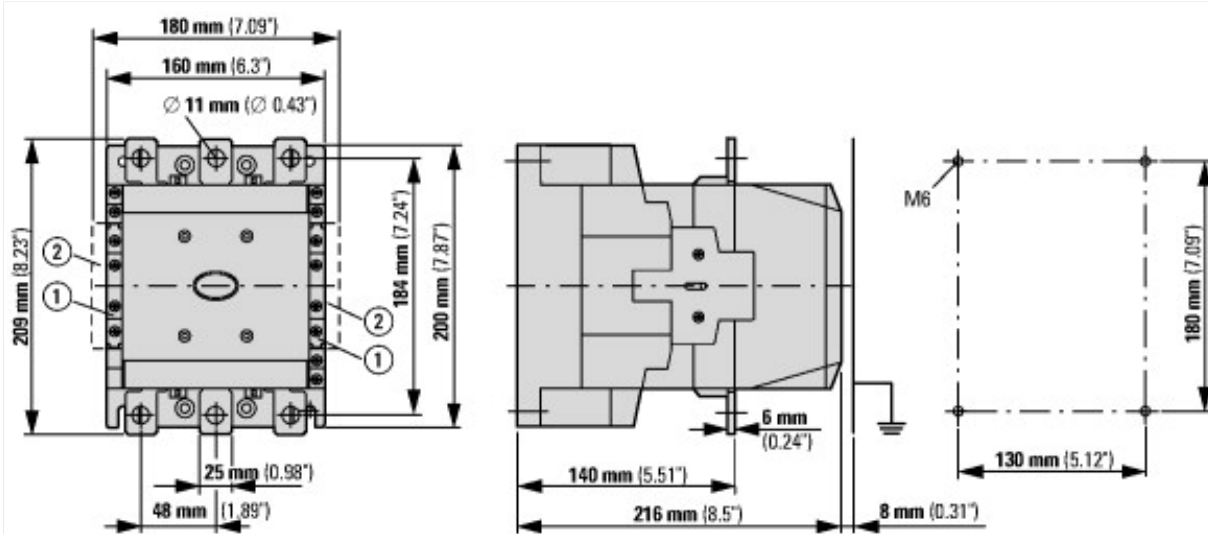

- ① DILM820-XHI11(V)-SI
- ② DILM820-XHI11-SA



# SCATTERGOOD & JOHNSON LTD

ELECTRICAL ENGINEERING & FLUID CONTROL DISTRIBUTORS

Est.1899

At Scattergood & Johnson Ltd, we pride ourselves on being a technical distributor to specialist industries.

Working with a range of quality product suppliers across a number of specialist markets, we are not your average 'box shifter' - we are your technical and supply chain partner.

We fully support every product we sell - for free! Our internal team and external sales engineers can answer any product or application question, no matter the complexity.

Backing up this technical ability is a range of 50,000+ products available from stock for nationwide next day delivery (same day if required!), or you can collect what you need from any of our trade counters around the UK.

Select your specialist interest below to learn more about how we can help.



Online, In Branch and On the Road - Scattergood & Johnson Ltd, there when you need us.

# [www.scatts.co.uk](http://www.scatts.co.uk)