

DATASHEET - DILEM4(415V50HZ,480V60HZ)



Contactor, 415 V 50 Hz, 480 V 60 Hz, 4 pole, 380 V 400 V, 4 kW, Screw terminals, AC operation



Part no. DILEM4(415V50HZ,480V60HZ)
Catalog No. 051807
Alternate Catalog No. XTMF9A00C

Delivery program

| | | | | |
|---|--------------|----|--|--|
| Product range | | | | Contactors |
| Application | | | | Mini Contactors for Motors and Resistive Loads |
| Subrange | | | | DILEM contactors |
| Utilization category | | | | AC-1: Non-inductive or slightly inductive loads, resistance furnaces NAC-3: Normal AC induction motors: starting, switch off during running AC-4: Normal AC induction motors: starting, plugging, reversing, inching |
| Connection technique | | | | Screw terminals |
| Number of poles | | | | 4 pole |
| Rated operational current | | | | |
| AC-3 | | | | |
| 380 V 400 V | I_e | A | | 9 |
| AC-1 | | | | |
| Conventional free air thermal current, 3 pole, 50 - 60 Hz | | | | |
| Open | | | | |
| at 40 °C | $I_{th}=I_e$ | A | | 22 |
| Max. rating for three-phase motors, 50 - 60 Hz | | | | |
| AC-3 | | | | |
| 220 V 230 V | P | kW | | 2.2 |
| 380 V 400 V | P | kW | | 4 |
| 660 V 690 V | P | kW | | 4 |
| AC-4 | | | | |
| 220 V 230 V | P | kW | | 1.5 |
| 380 V 400 V | P | kW | | 3 |
| 660 V 690 V | P | kW | | 3 |
| Contact sequence | | | | |
| For use with | | | | ...DILEM ...DILE |
| Actuating voltage | | | | 415 V 50 Hz, 480 V 60 Hz |
| Voltage AC/DC | | | | AC operation |

Technical data

| | | | | |
|--|--------------|---------------|--|--|
| General | | | | |
| Standards | | | | IEC/EN 60947, VDE 0660, CSA, UL |
| Lifespan, mechanical; Coil 50/60 Hz | Operations | $\times 10^6$ | | 7 |
| Lifespan, mechanical | Operations | $\times 10^6$ | | 20 |
| Maximum operating frequency | | | | |
| Mechanical | | Ops./h | | 9000 |
| electrical (Contactors without overload relay) | Operations/h | | | Page 05/070 |
| Climatic proofing | | | | Damp heat, constant, to IEC 60068-2-78 Damp heat, cyclic, to IEC 60068-2-30 |
| Ambient temperature | | | | |
| Open | | °C | | -25 - +50 |
| Enclosed | | °C | | - 25 - 40 |
| Storage | | °C | | |

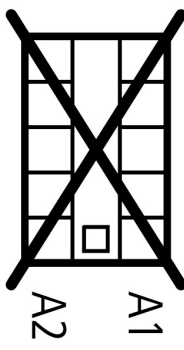
| | | |
|---|-----------------|--|
| Min. ambient temperature, storage | °C | - 40 |
| Ambient temperature, storage max. | °C | + 80 |
| Mounting position | | As required, except vertical with terminals A1/A2 at the bottom |
| Mounting position | |  |
| Mechanical shock resistance (IEC/EN 60068-2-27) | | |
| Half-sinusoidal shock, 10 ms | | |
| Basic unit without auxiliary contact module | | |
| Main contacts, make contacts | g | 10 |
| Basic unit with auxiliary contact module | | |
| Main contacts make contact | g | |
| Make | g | 10 |
| Auxiliary contacts Make/break contacts | g | 20 / 20 |
| Degree of Protection | | IP20 |
| Protection against direct contact when actuated from front (EN 50274) | | Finger and back-of-hand proof |
| Altitude | m | Max. 2000 |
| Weight | kg | 0.17 |
| Terminal capacity of auxiliary and main contacts | | |
| Screw terminals | | |
| Solid | mm ² | 1 x (0.75 - 2.5) 2 x (0.75 - 2.5) |
| Flexible with ferrule | mm ² | 1 x (0.75 - 1.5) 2 x (0.75 - 1.5) |
| Solid or stranded | AWG | 18 - 14 |
| Stripping length | mm | 8 |
| Terminal screw | | M3.5 |
| Pozidriv screwdriver | Size | 2 |
| Standard screwdriver | mm | 0.8 x 5.5 1 x 6 |
| Max. tightening torque | Nm | 1.2 |

Main conducting paths

| | | | |
|---|------------------|------|-------|
| Rated impulse withstand voltage | U _{imp} | V AC | 6000 |
| Overvoltage category/pollution degree | | | III/3 |
| Rated insulation voltage | U _i | V AC | 690 |
| Rated operational voltage | U _e | V AC | 690 |
| Safe isolation to EN 61140 | | | |
| between coil and contacts | | V AC | 300 |
| between the contacts | | V AC | 300 |
| Making capacity (cos φ to IEC/EN 60947) | | A | 110 |
| Breaking capacity | | | |
| 220 V 230 V | | A | 90 |
| 380 V 400 V | | A | 90 |
| 500 V | | A | 64 |
| 660 V 690 V | | A | 42 |
| Short-circuit protection maximum fuse | | | |
| Type "2", 500 V | gL/gG | A | 10 |
| Type "1", 500 V | gL/gG | A | 20 |

AC

| | | | |
|------|--|--|--|
| AC-1 | | | |
|------|--|--|--|

| | | | | |
|---|----------------|----|--|-----|
| Rated operational current | | | | |
| Conventional free air thermal current, 3 pole, 50 - 60 Hz | | | | |
| Open | | | | |
| at 40 °C | $I_{th} = I_e$ | A | 22 | |
| at 50 °C | $I_{th} = I_e$ | A | 20 | |
| at 55 °C | $I_{th} = I_e$ | A | 19 | |
| enclosed | I_{th} | A | 16 | |
| Notes | | | At maximum permissible ambient air temperature. | |
| Conventional free air thermal current, 1 pole | | | | |
| Notes | | | At maximum permissible ambient air temperature. | |
| open | I_{th} | A | 60 | |
| enclosed | I_{th} | A | 50 | |
| AC-3 | | | | |
| Rated operational current | | | | |
| Open, 3-pole: 50 – 60 Hz | | | | |
| Notes | | | At maximum permissible ambient temperature (open.) | |
| 220 V 230 V | I_e | A | 9 | |
| 240 V | I_e | A | 9 | |
| 380 V 400 V | I_e | A | 9 | |
| 415 V | I_e | A | 9 | |
| 440V | I_e | A | 9 | |
| 500 V | I_e | A | 6.4 | |
| 660 V 690 V | I_e | A | 4.8 | |
| Motor rating | | P | kWh | |
| 220 V 230 V | P | kW | | 2.2 |
| 240V | P | kW | | 2.5 |
| 380 V 400 V | P | kW | | 4 |
| 415 V | P | kW | | 4.3 |
| 440 V | P | kW | | 4.6 |
| 500 V | P | kW | | 4 |
| 660 V 690 V | P | kW | | 4 |
| AC-4 | | | | |
| Rated operational current | | | | |
| Open, 3-pole: 50 – 60 Hz | | | | |
| Notes | | | At maximum permissible ambient air temperature. | |
| 220 V 230 V | I_e | A | 6.6 | |
| 240 V | I_e | A | 6.6 | |
| 380 V 400 V | I_e | A | 6.6 | |
| 415 V | I_e | A | 6.6 | |
| 440 V | I_e | A | 6.6 | |
| 500 V | I_e | A | 5 | |
| 660 V 690 V | I_e | A | 3.4 | |
| Motor rating | | P | kWh | |
| 220 V 230 V | P | kW | | 1.5 |
| 240 V | P | kW | | 1.8 |
| 380 V 400 V | P | kW | | 3 |
| 415 V | P | kW | | 3.1 |
| 440 V | P | kW | | 3.3 |
| 500 V | P | kW | | 3 |
| 660 V 690 V | P | kW | | 3 |
| DC | | | | |
| Rated operational current open | | | | |
| DC-1 | | | | |
| 12 V | I_e | A | 20 | |

| | | | |
|------------------------------------|-------|---|-----|
| 24 V | I_e | A | 20 |
| 60 V | I_e | A | 20 |
| 110 V | I_e | A | 20 |
| 220 V | I_e | A | 20 |
| Current heat losses (3- or 4-pole) | | | |
| at I_{th} , 50 °C | | W | 7.9 |

Magnet systems

| | | | |
|--|---------|---------|-----------|
| Voltage tolerance | | | |
| AC operated | | | |
| Single-voltage coil 50 Hz and dual-voltage coil 50 Hz, 60 Hz | Pick-up | $x U_c$ | 0.8 - 1.1 |
| Dual-frequency coil 50/60 Hz | Pick-up | $x U_c$ | |
| Voltage tolerance Dual-frequency coil 50/60 Hz, max. pick-up voltage | | $x U_c$ | 1.1 |
| Power consumption | | | |
| AC operation | | | |
| Single-voltage coil 50 Hz and dual-voltage coil 50 Hz, 60 Hz | Pick-up | VA | 25 |
| Single-voltage coil 50 Hz and dual-voltage coil 50 Hz, 60 Hz | Pick-up | W | 22 |
| Single-voltage coil 50 Hz and dual-voltage coil 50 Hz, 60 Hz | Sealing | VA | 4.6 |
| Single-voltage coil 50 Hz and dual-voltage coil 50 Hz, 60 Hz | Sealing | W | 1.8 |
| Duty factor | | % DF | 100 |
| Switching times at 100 % U_c | | | |
| Make contact | | ms | |
| Closing delay | | ms | |
| Closing delay min. | | ms | 14 |
| Closing delay max. | | ms | 21 |
| Opening delay | | ms | |
| Opening delay min. | | ms | 8 |
| Opening delay max. | | ms | 18 |
| Closing delay with top mounting auxiliary contact | | ms | 45 |
| Reversing contactors | | | |
| Changeover time at 110 % U_c | | | |
| Changeover time min. | | ms | 16 |
| Changeover time max. | | ms | 21 |
| Arcing time at 690 V AC | | ms | 12 |

Auxiliary contacts

| | | | |
|--|-----------|------|-------|
| Positive operating contacts to EN 60947-5-1 appendix L, including auxiliary contact module | | | Yes |
| Rated impulse withstand voltage | U_{imp} | V AC | 6000 |
| Overvoltage category/pollution degree | | | III/3 |
| Rated insulation voltage | U_i | V AC | 690 |
| Rated operational voltage | U_e | V AC | 600 |
| Safe isolation to EN 61140 | | | |
| between coil and auxiliary contacts | | V AC | 300 |
| between the auxiliary contacts | | V AC | 300 |
| Rated operational current | | | |
| AC-15 | | | |
| 220 V 240 V | I_e | A | 6 |
| 380 V 415 V | I_e | A | 3 |
| 500 V | I_e | A | 1.5 |
| DC L/R \leq 15 ms | | | |
| Contacts in series: | | A | |
| 1 | 24 V | A | 2.5 |
| 2 | 60 V | A | 2.5 |
| 3 | 100 V | A | 1.5 |
| 3 | 220 V | A | 0.5 |
| Conv. thermal current | I_{th} | A | 10 |

| | | | |
|---|--------------|---------------|--|
| Control circuit reliability | Failure rate | λ | $<10^{-8}$, < one failure at 100 million operations (at $U_e = 24$ V DC, $U_{min} = 17$ V, $I_{min} = 5.4$ mA) |
| Component lifespan at $U_e = 240$ V | | | |
| AC-15 | Operations | $\times 10^6$ | 0.2 |
| DC current | | | |
| L/R = 50 ms: 2 contacts in series at $I_e = 0.5$ A | Operations | $\times 10^6$ | 0.15 |
| Notes | | | Switch-on and switch-off conditions based on DC-13, time constant as specified |
| Short-circuit rating without welding | | | |
| Maximum overcurrent protective device | | | |
| Short-circuit protection only | | | PKZM0-4 |
| Short-circuit protection maximum fuse | | | |
| 500 V | | A gG/gL | 6 |
| 500 V | | A fast | 10 |
| Current heat loss at a load of I_{th} per contact | | W | 1.1 |

Rating data for approved types

| | | | |
|------------------------------|--|------|-----|
| Switching capacity | | | |
| Maximum motor rating | | | |
| Three-phase | | | |
| 200 V 208 V | | HP | 2 |
| 230 V 240 V | | HP | 3 |
| 460 V 480 V | | HP | 5 |
| 575 V 600 V | | HP | 5 |
| Single-phase | | | |
| 115 V 120 V | | HP | 0.5 |
| 230 V 240 V | | HP | 1.5 |
| General use | | A | 15 |
| Short Circuit Current Rating | | SCCR | |
| Basic Rating | | | |
| SCCR | | kA | 5 |
| max. Fuse | | A | 45 |

Design verification as per IEC/EN 61439

| | | | |
|--|------------|----|--|
| Technical data for design verification | | | |
| Rated operational current for specified heat dissipation | I_n | A | 22 |
| Heat dissipation per pole, current-dependent | P_{vid} | W | 2.39 |
| Equipment heat dissipation, current-dependent | P_{vid} | W | 9.56 |
| Static heat dissipation, non-current-dependent | P_{vs} | W | 1.8 |
| Heat dissipation capacity | P_{diss} | W | 0 |
| Operating ambient temperature min. | | °C | -25 |
| Operating ambient temperature max. | | °C | 50 |
| IEC/EN 61439 design verification | | | |
| 10.2 Strength of materials and parts | | | |
| 10.2.2 Corrosion resistance | | | Meets the product standard's requirements. |
| 10.2.3.1 Verification of thermal stability of enclosures | | | Meets the product standard's requirements. |
| 10.2.3.2 Verification of resistance of insulating materials to normal heat | | | Meets the product standard's requirements. |
| 10.2.3.3 Verification of resistance of insulating materials to abnormal heat and fire due to internal electric effects | | | Meets the product standard's requirements. |
| 10.2.4 Resistance to ultra-violet (UV) radiation | | | Meets the product standard's requirements. |
| 10.2.5 Lifting | | | Does not apply, since the entire switchgear needs to be evaluated. |
| 10.2.6 Mechanical impact | | | Does not apply, since the entire switchgear needs to be evaluated. |
| 10.2.7 Inscriptions | | | Meets the product standard's requirements. |
| 10.3 Degree of protection of ASSEMBLIES | | | Does not apply, since the entire switchgear needs to be evaluated. |

| | | |
|--|--|--|
| 10.4 Clearances and creepage distances | | Meets the product standard's requirements. |
| 10.5 Protection against electric shock | | Does not apply, since the entire switchgear needs to be evaluated. |
| 10.6 Incorporation of switching devices and components | | Does not apply, since the entire switchgear needs to be evaluated. |
| 10.7 Internal electrical circuits and connections | | Is the panel builder's responsibility. |
| 10.8 Connections for external conductors | | Is the panel builder's responsibility. |
| 10.9 Insulation properties | | |
| 10.9.2 Power-frequency electric strength | | Is the panel builder's responsibility. |
| 10.9.3 Impulse withstand voltage | | Is the panel builder's responsibility. |
| 10.9.4 Testing of enclosures made of insulating material | | Is the panel builder's responsibility. |
| 10.10 Temperature rise | | The panel builder is responsible for the temperature rise calculation. Eaton will provide heat dissipation data for the devices. |
| 10.11 Short-circuit rating | | Is the panel builder's responsibility. The specifications for the switchgear must be observed. |
| 10.12 Electromagnetic compatibility | | Is the panel builder's responsibility. The specifications for the switchgear must be observed. |
| 10.13 Mechanical function | | The device meets the requirements, provided the information in the instruction leaflet (IL) is observed. |

Technical data ETIM 7.0

| | | |
|---|----|------------------|
| Low-voltage industrial components (EG000017) / Power contactor, AC switching (EC000066) | | |
| Electric engineering, automation, process control engineering / Low-voltage switch technology / Contactor (LV) / Power contactor, AC switching (ecl@ss10.0.1-27-37-10-03 [AAB718015]) | | |
| Rated control supply voltage Us at AC 50HZ | V | 415 - 415 |
| Rated control supply voltage Us at AC 60HZ | V | 480 - 480 |
| Rated control supply voltage Us at DC | V | 0 - 0 |
| Voltage type for actuating | | AC |
| Rated operation current Ie at AC-1, 400 V | A | 22 |
| Rated operation current Ie at AC-3, 400 V | A | 9 |
| Rated operation power at AC-3, 400 V | kW | 4 |
| Rated operation current Ie at AC-4, 400 V | A | 6.6 |
| Rated operation power at AC-4, 400 V | kW | 3 |
| Rated operation power NEMA | kW | 3.7 |
| Modular version | | No |
| Number of auxiliary contacts as normally open contact | | 0 |
| Number of auxiliary contacts as normally closed contact | | 0 |
| Type of electrical connection of main circuit | | Screw connection |
| Number of normally closed contacts as main contact | | 0 |
| Number of main contacts as normally open contact | | 4 |

Approvals

| | | |
|--------------------------------------|--|---|
| Product Standards | | IEC/EN 60947-4-1; UL 508; CSA-C22.2 No. 14-05; CE marking |
| UL File No. | | E29096 |
| UL Category Control No. | | NLDX |
| CSA File No. | | 012528 |
| CSA Class No. | | 3211-04 |
| North America Certification | | UL listed, CSA certified |
| Specially designed for North America | | No |

Characteristics

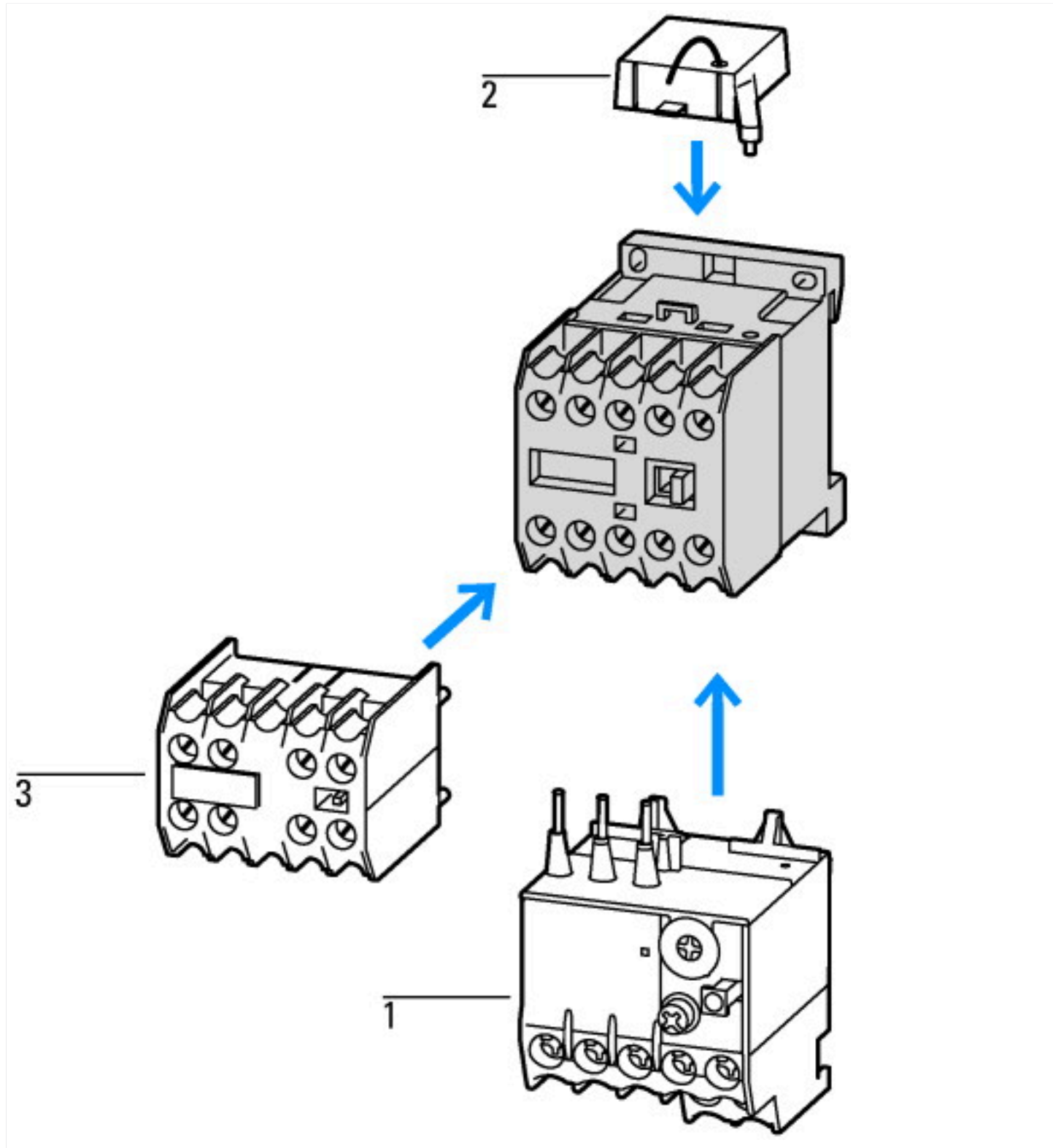

- 1: Overload relay
 - 2: Suppressor
 - 3: Auxiliary contact modules
- Enclosure totally insulated

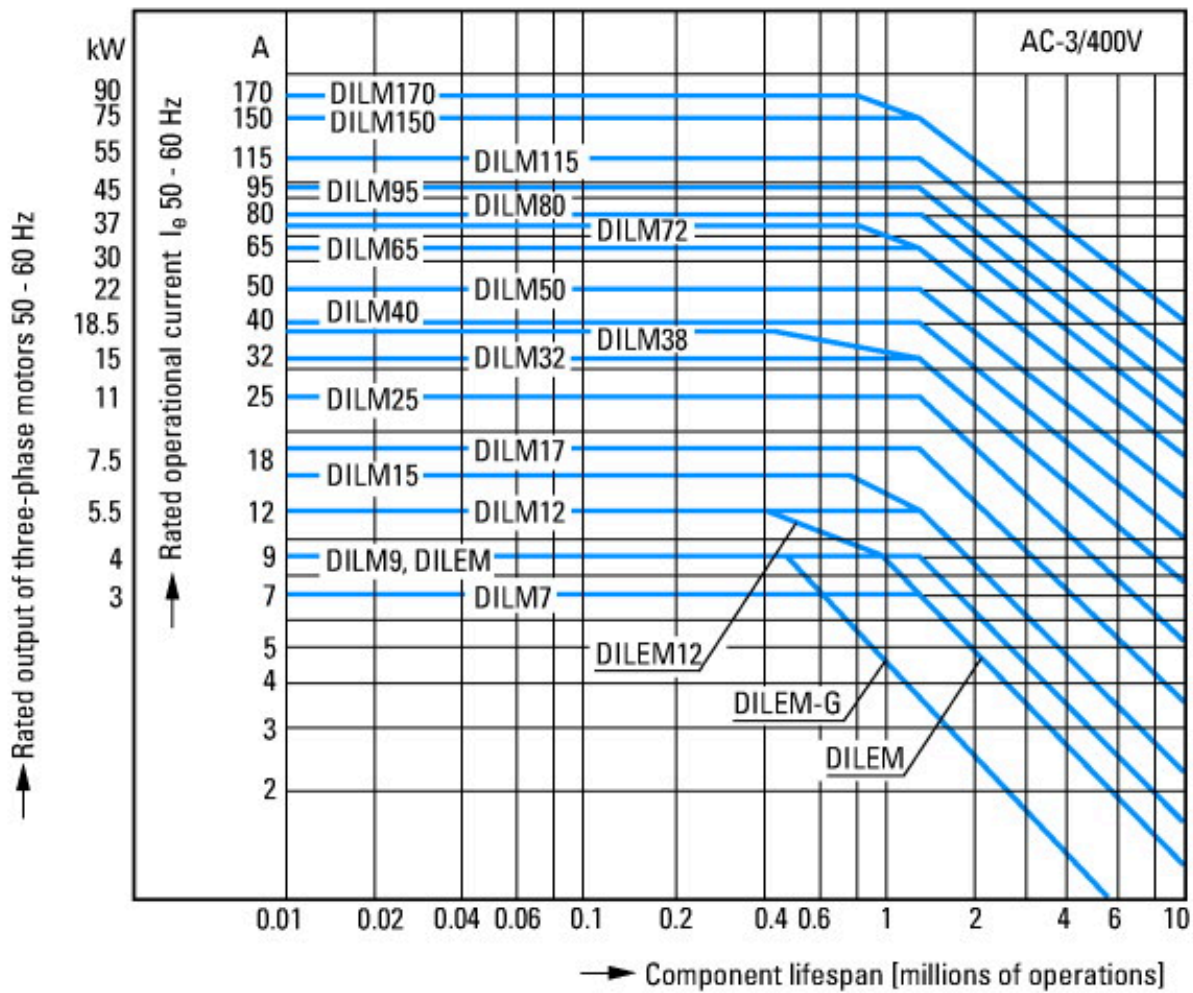

- Squirrel-cage motor
- Operating characteristics
- Starting: from rest
- Stopping: after attaining full running speed
- Electrical characteristics
- Make: up to 6 x rated motor current
- Break: up to 1 x rated motor current
- Utilization category
- 100 % AC-3
- Typical applications
- Compressors
- Lifts
- Mixers
- Pumps
- Escalators
- Agitators
- Fans
- Conveyor belts
- Centrifuges
- Hinged flaps
- Bucket-elevators
- Air conditioning system
- General drives in manufacturing and processing machines

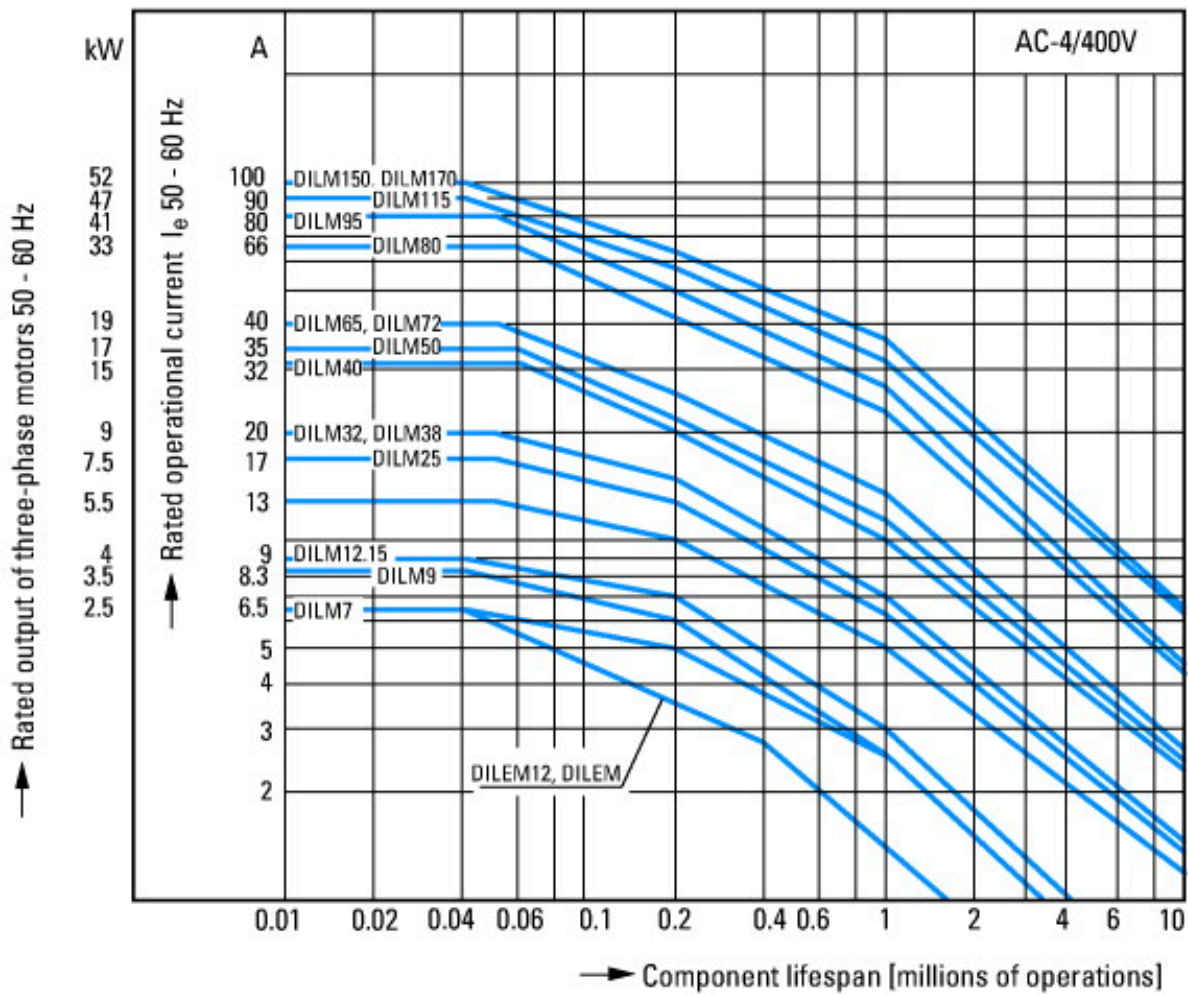

- Extreme switching duty
- Squirrel-cage motor
- Operating characteristics
- Inching, plugging, reversing
- Electrical characteristics
- Make: up to 6 x rated motor current
- Break: up to 6 x rated motor current
- Utilization category
- 100 % AC-4
- Typical applications
- Printing presses
- Wire-drawing machines
- Centrifuges
- Special drives for manufacturing and processing machines

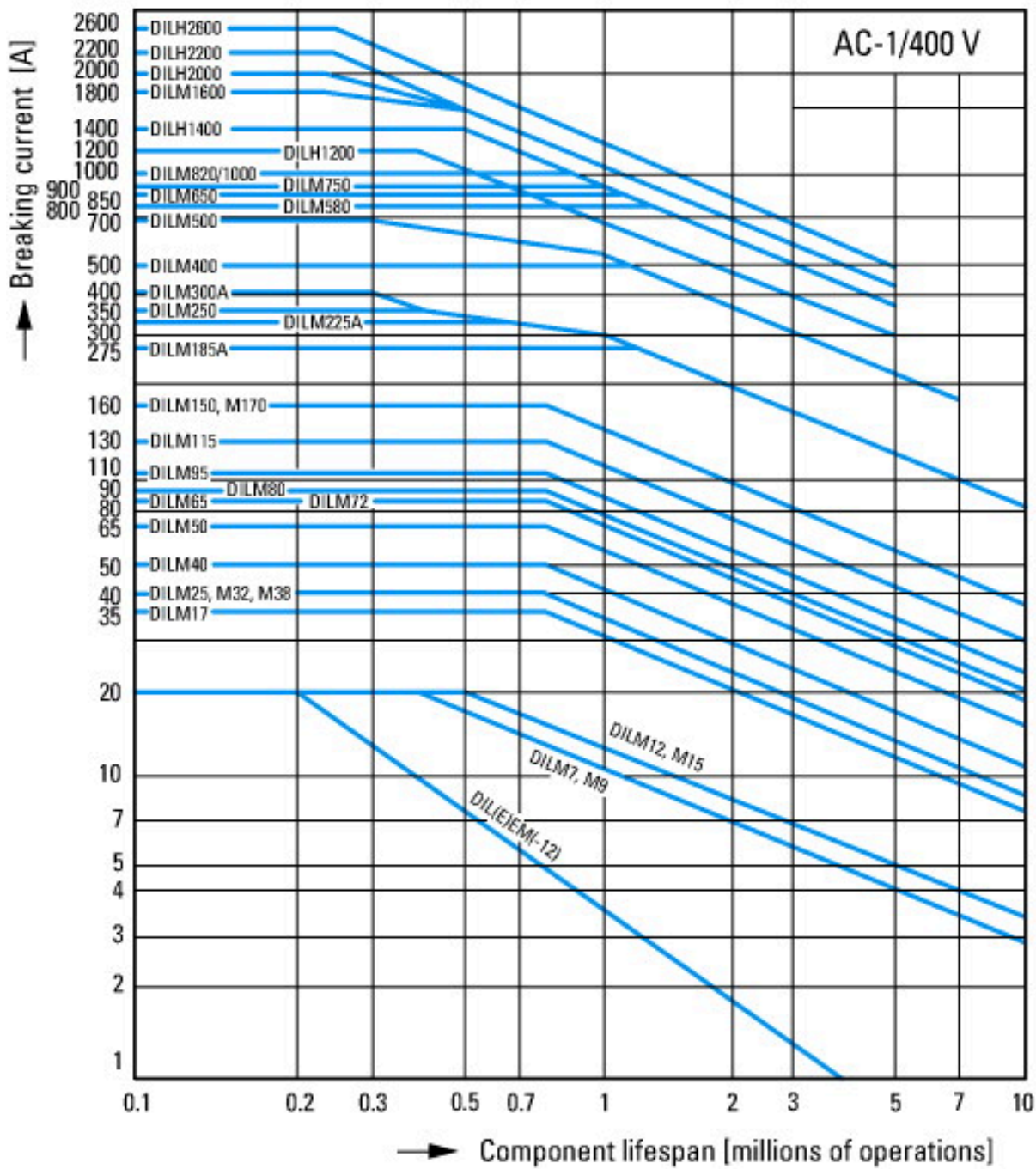

Switching duty for non-motor loads, 3-pole, 4-pole
 Operating characteristics
 Non-inductive or slightly inductive loads
 Electrical characteristics
 Make: 1 x rated current
 Break: 1 x rated current
 Utilization category
 100 % AC-1
 Typical applications
 Electric heat

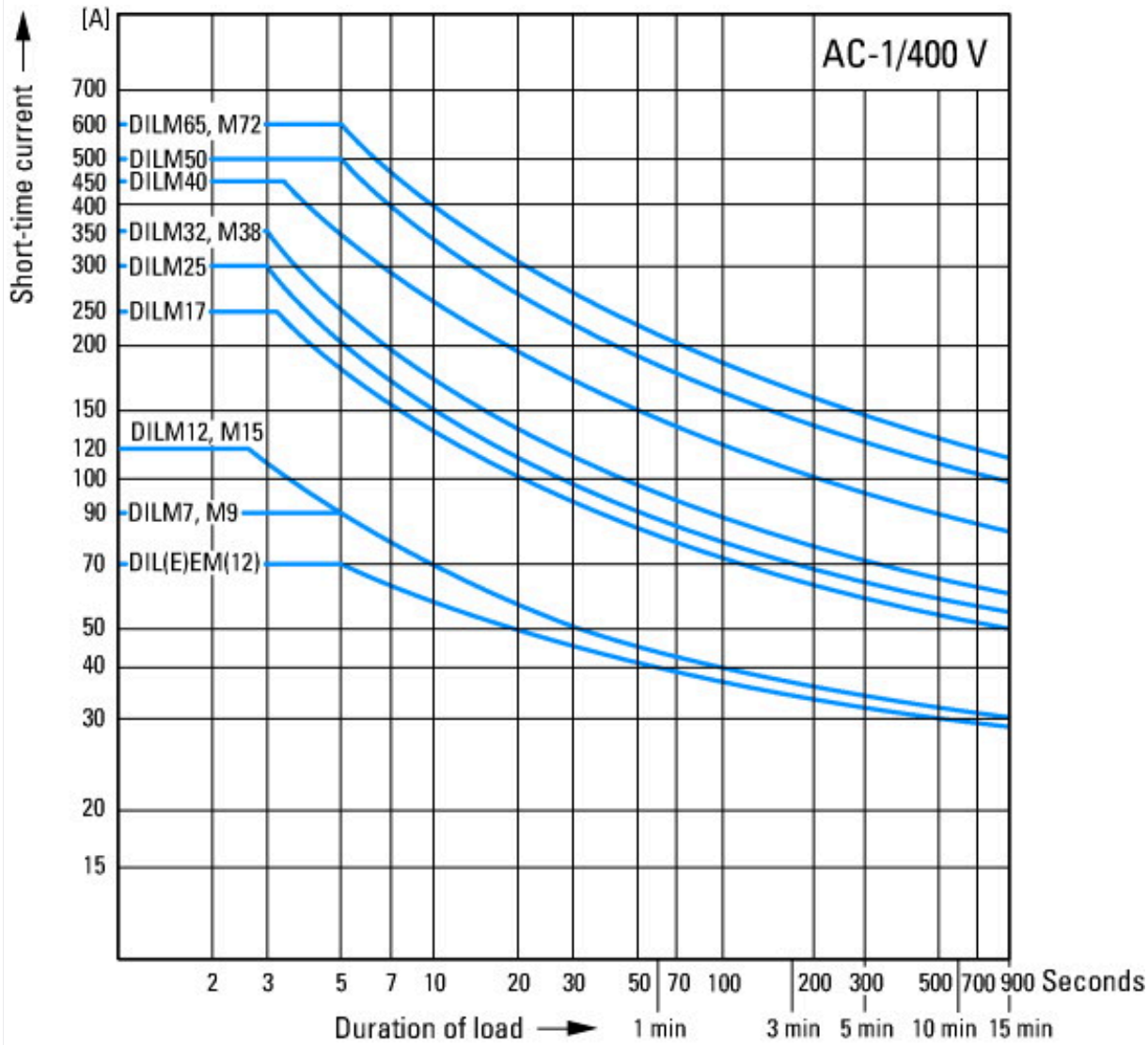

Short-time loading, 3-pole
 Time interval between two loading cycles: 15 minutes

Dimensions

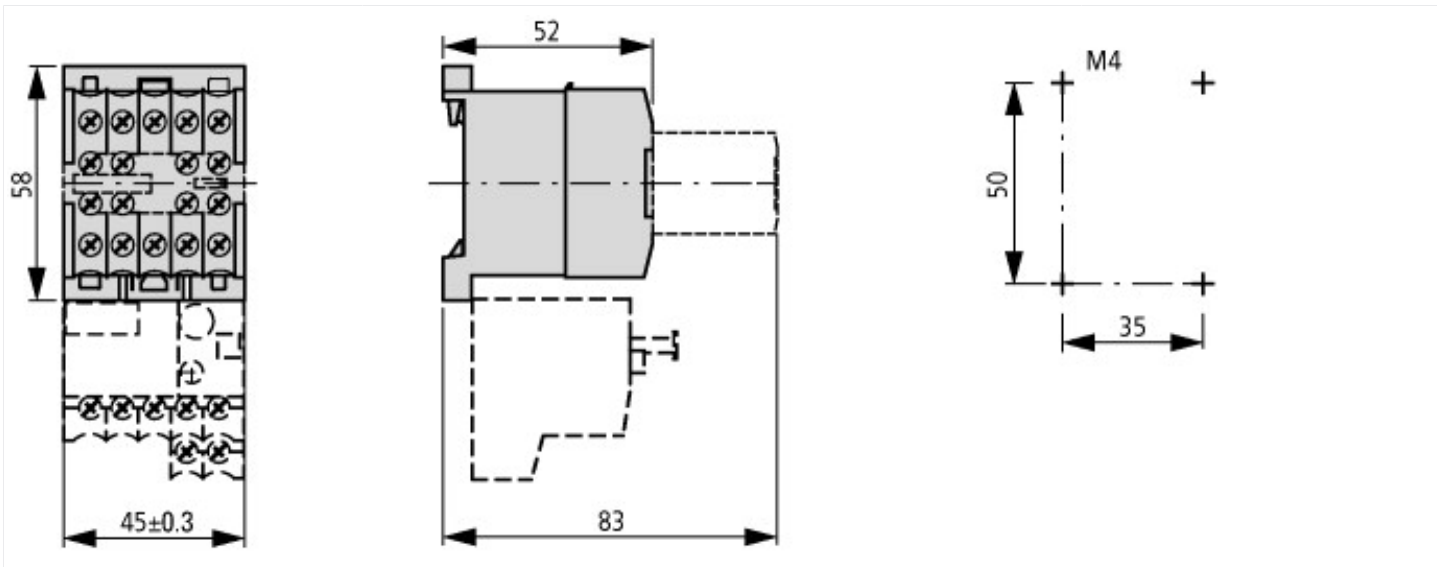

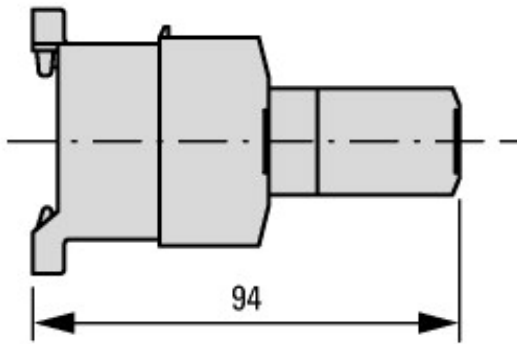
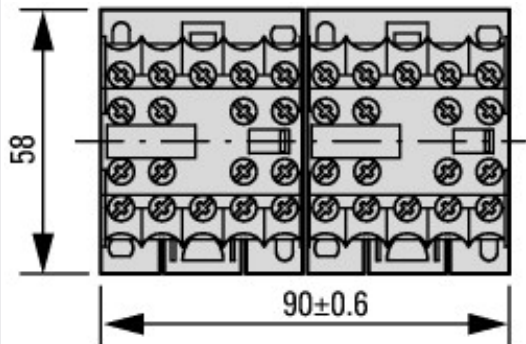

2DILE-... + MVDILE + ...DILE
2DILE-...-G + MVDILE + ...DILE

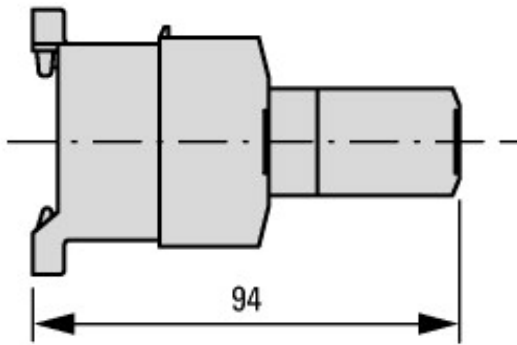
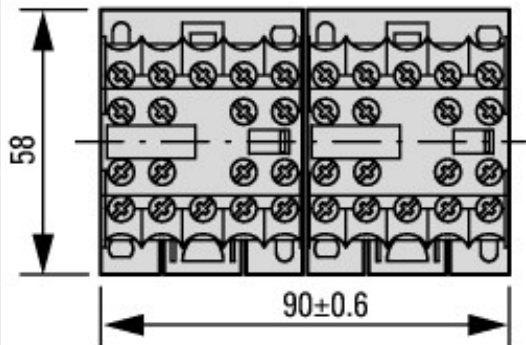

2DILE-... + MVDILE + ...DILE
2DILE-...-G + MVDILE + ...DILE

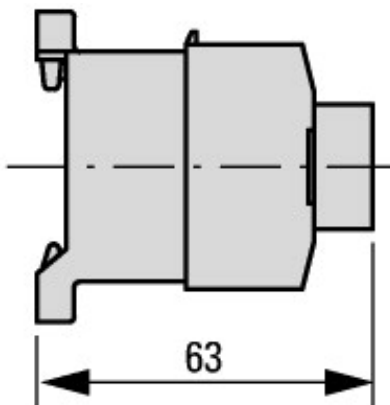
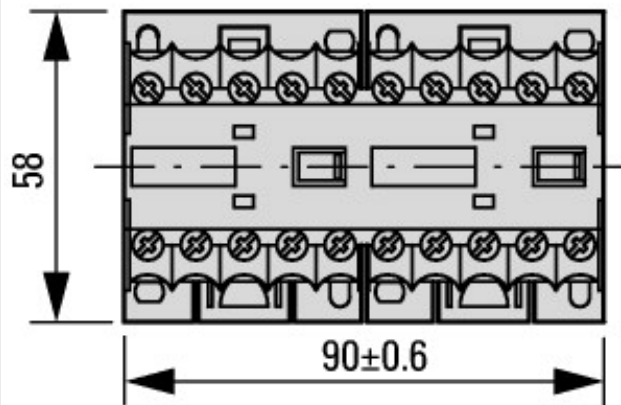

2DILE-... + MVDILE
2DILE-...-G + MVDILE



SCATTERGOOD & JOHNSON LTD

ELECTRICAL ENGINEERING & FLUID CONTROL DISTRIBUTORS

Est.1899

At Scattergood & Johnson Ltd, we pride ourselves on being a technical distributor to specialist industries.

Working with a range of quality product suppliers across a number of specialist markets, we are not your average 'box shifter' - we are your technical and supply chain partner.

We fully support every product we sell - for free! Our internal team and external sales engineers can answer any product or application question, no matter the complexity.

Backing up this technical ability is a range of 50,000+ products available from stock for nationwide next day delivery (same day if required!), or you can collect what you need from any of our trade counters around the UK.

Select your specialist interest below to learn more about how we can help.

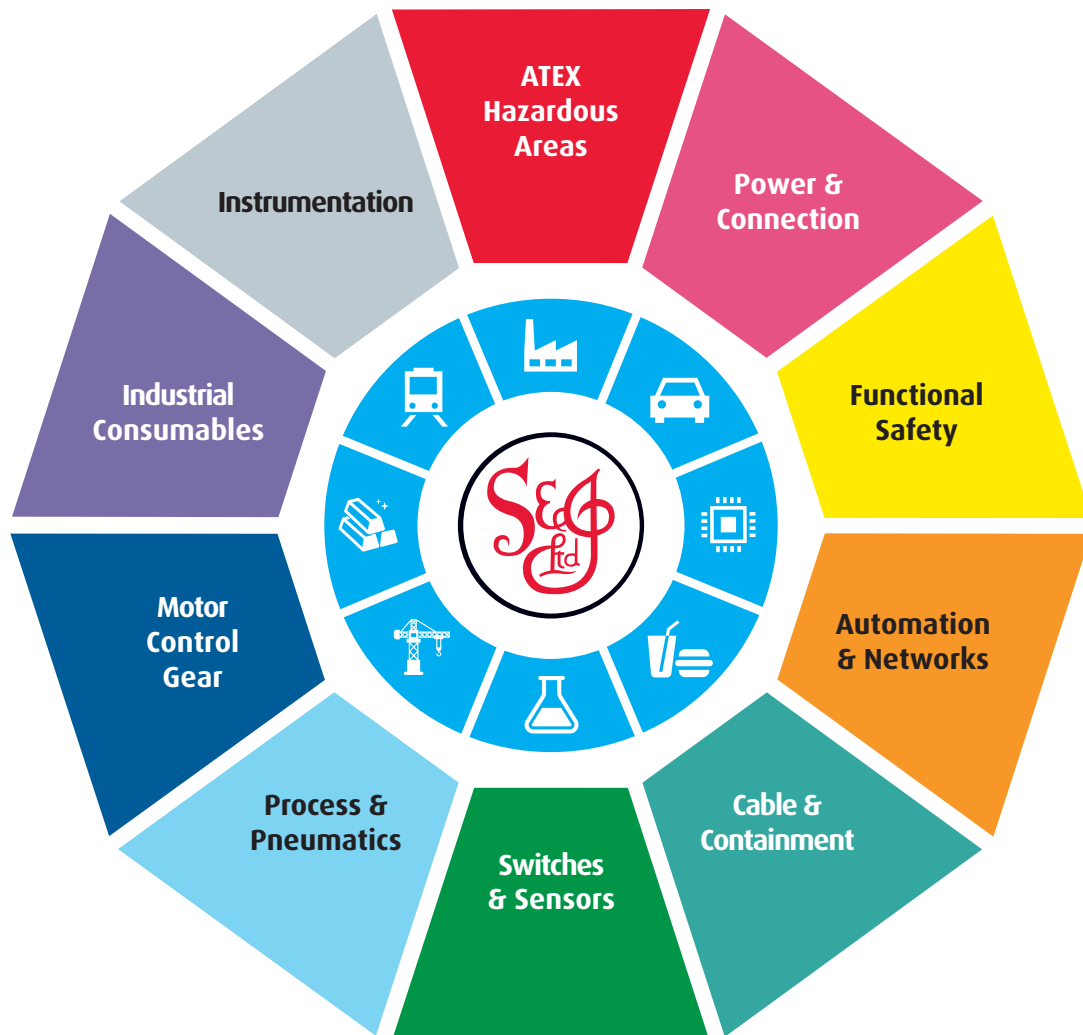

Online, In Branch and On the Road - Scattergood & Johnson Ltd, there when you need us.

www.scatts.co.uk