

## DATASHEET - PKZM0-1



## Motor-protective circuit-breaker, 3p, Ir=0.63-1A, screw connection



Part no. PKZM0-1  
 Catalog No. 072734  
 Alternate Catalog No. XTPR001BC1NL  
 EL-Nummer (Norway) 4355125

## Delivery program

|  |       |          |   |   |
|--|-------|----------|---|---|
| Product range  |       |          |   | PKZM0 motor protective circuit-breakers up to 32 A  |
| Basic function   |       |          |   | Motor protection  |
|  |       |          |   |   |
| Notes  |       |          |   | Also suitable for motors with efficiency class IE3.<br>IE3-ready devices are identified by the logo on their packaging. |
| Connection technique   |       |          |   | Screw terminals   |
| Contact sequence   |       |          |   |   |
| <b>Max. motor rating</b>   |       |          |   |   |
| AC-3   |       |          |   |   |
| 220 V 230 V 240 V  | P     | kW       |   | 0.12  |
| 380 V 400 V 415 V  | P     | kW       |   | 0.25  |
| 440 V  | P     | kW       |   | 0.25  |
| 500 V  | P     | kW       |   | 0.37  |
| 660 V 690 V  | P     | kW       |   | 0.55  |
| Rated uninterrupted current  | $I_u$ | A        |   | 1   |
| <b>Setting range</b>   |       |          |   |   |
| Overload releases  |       | $I_r$    | A | 0.63 - 1  |
| short-circuit release  |       |          |   |   |
| max.   |       | $I_{rm}$ | A | 15.5  |
| Phase-failure sensitivity  |       |          |   | IEC/EN 60947-4-1, VDE 0660 Part 102   |
| Explosion protection (according to ATEX 94/9/EC)   |       |          |   | PTB 10, ATEX 3013, Ex II(2) GD<br>Observe manual MNO3402003Z-DE/EN.   |
| <b>Notes</b> Overload trigger: tripping class 10 A<br>Can be snapped on to IEC/EN 60715 top-hat rail with 7.5 or 15 mm height. |       |          |   |   |

## Technical data

|                     |  |    |  |  |
|---------------------|--|----|--|--|
| <b>General</b>      |  |    |  |  |
| Standards           |  |    |  | IEC/EN 60947, VDE 0660, UL, CSA  |
| Climatic proofing   |  |    |  | Damp heat, constant, to IEC 60068-2-78<br>Damp heat, cyclic, to IEC 60068-2-30 |
| Ambient temperature |  |    |  |  |
| Storage             |  | °C |  | - 40 - 80  |
| Open                |  | °C |  | -25 - +55  |
| Enclosed            |  | °C |  | - 25 - 40  |

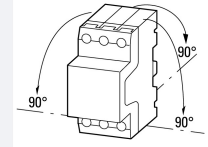
|   |  |                 |   |
|---|--|-----------------|---|
| Mounting position   |  |                 |  |
| Direction of incoming supply  |  |                 | as required   |
| Degree of protection  |  |                 |   |
| Device  |  |                 | IP20  |
| Terminations  |  |                 | IP00  |
| Protection against direct contact when actuated from front (EN 50274)     |  |                 | Finger and back-of-hand proof   |
| Mechanical shock resistance half-sinusoidal shock 10 ms to IEC 60068-2-27 |  | g               | 25  |
| Altitude  |  | m               | Max. 2000   |
| Terminal capacity main cable  |  |                 |   |
| Screw terminals   |  |                 |   |
| Solid   |  | mm <sup>2</sup> | 1 x (1 - 6)<br>2 x (1 - 6)  |
| Flexible with ferrule to DIN 46228  |  | mm <sup>2</sup> | 1 x (1 - 6)<br>2 x (1 - 6)  |
| Solid or stranded   |  | AWG             | 18 - 10   |
| Stripping length  |  | mm              | 10  |
| Specified tightening torque for terminal screws                           |  |                 |   |
| Main cable  |  | Nm              | 1.7   |
| Control circuit cables  |  | Nm              | 1   |

**Main conducting paths**

|   |             |               |                          |
|---|-------------|---------------|--------------------------|
| Rated impulse withstand voltage                         | $U_{imp}$   | V AC          | 6000                     |
| Overvoltage category/pollution degree                   |             |               | III/3                    |
| Rated operational voltage                               | $U_e$       | V AC          | 690                      |
| Rated uninterrupted current = rated operational current | $I_u = I_e$ | A             | 1                        |
| Rated frequency   | f           | Hz            | 40 - 60                  |
| Current heat loss (3 pole at operating temperature)     |             | W             | 5.33                     |
| Impedance per pole                                      |             | mΩ            | 1700                     |
| Lifespan, mechanical                                    | Operations  | $\times 10^6$ | 0.1                      |
| Lifespan, electrical (AC-3 at 400 V)                    |             |               |                          |
| Lifespan, electrical                                    | Operations  | $\times 10^6$ | 0.1                      |
| Max. operating frequency                                |             | Ops/h         | 40                       |
| Short-circuit rating                                    |             |               |                          |
| DC  |             |               |                          |
| Short-circuit rating                                    |             | kA            | 60                       |
| Notes   |             |               | up to 250 V              |
| Motor switching capacity                                |             |               |                          |
| AC-3 (up to 690V)                                       |             | A             | 1                        |
| DC-5 (up to 250V)                                       |             | A             | 1 (3 contacts in series) |

**Trip blocks**

|   |  |              |  |
|---|--|--------------|--|
| Temperature compensation                              |  |              |  |
| to IEC/EN 60947, VDE 0660                             |  | °C           | - 5 ... 40                             |
| Operating range                                       |  | °C           | - 25 ... 55                            |
| Temperature compensation residual error for T > 40 °C |  |              | ≤ 0.25 %/K                             |
| Setting range of overload releases                    |  | $\times I_u$ | 0.6 - 1                                |
| short-circuit release                                 |  |              | Basic device, fixed: 15.5 $\times I_u$ |
| Short-circuit release tolerance                       |  |              | ± 20%                                  |
| Phase-failure sensitivity                             |  |              | IEC/EN 60947-4-1, VDE 0660 Part 102    |

**Rating data for approved types**

|                      |  |    |   |
|----------------------|--|----|---|
| Switching capacity   |  |    |   |
| Maximum motor rating |  |    |   |
| Three-phase          |  |    |   |
| 200 V<br>208 V       |  | HP | Hinweis: Motorleistung in diesem Bereich nach Bemessungsstrom berechnen.<br>Angegebene Werte nach NEC Table 430-150 |

|  |      |   |
|--|------|---|
| 230 V<br>240 V                                 | HP   | Hinweis: Motorleistung in diesem Bereich nach Bemessungsstrom berechnen.<br>Angegebene Werte nach NEC Table 430-150 |
| 460 V<br>480 V                                 | HP   | Hinweis: Motorleistung in diesem Bereich nach Bemessungsstrom berechnen.<br>Angegebene Werte nach NEC Table 430-150 |
| 575 V<br>600 V                                 | HP   | Hinweis: Motorleistung in diesem Bereich nach Bemessungsstrom berechnen.<br>Angegebene Werte nach NEC Table 430-150 |
| Short Circuit Current Rating, type E           | SCCR |   |
| 240 V  | kA   | 65  |
| 480 Y / 277 V                                  | kA   | 65  |
| 600 Y / 347 V                                  | kA   | 50  |
| Accessories required                           |      | BK25/3-PKZ0-E   |
| Short Circuit Current Rating, group protection | SCCR |   |
| 600 V High Fault                               |      |   |
| SCCR (fuse)                                    | kA   | 50  |
| max. Fuse                                      | A    | 600   |
| SCCR (CB)                                      | kA   | 50  |
| max. CB  | A    | 600   |

### Design verification as per IEC/EN 61439

|  |            |    |  |
|--|------------|----|--|
| Technical data for design verification   |            |    |  |
| Rated operational current for specified heat dissipation   | $I_n$      | A  | 1  |
| Heat dissipation per pole, current-dependent   | $P_{vid}$  | W  | 1.78   |
| Equipment heat dissipation, current-dependent  | $P_{vid}$  | W  | 5.33   |
| Static heat dissipation, non-current-dependent   | $P_{vs}$   | W  | 0  |
| Heat dissipation capacity  | $P_{diss}$ | W  | 0  |
| Operating ambient temperature min.   |            | °C | -25  |
| Operating ambient temperature max.   |            | °C | 55   |
| IEC/EN 61439 design verification   |            |    |  |
| 10.2 Strength of materials and parts   |            |    |  |
| 10.2.2 Corrosion resistance  |            |    | Meets the product standard's requirements.   |
| 10.2.3.1 Verification of thermal stability of enclosures   |            |    | Meets the product standard's requirements.   |
| 10.2.3.2 Verification of resistance of insulating materials to normal heat   |            |    | Meets the product standard's requirements.   |
| 10.2.3.3 Verification of resistance of insulating materials to abnormal heat and fire due to internal electric effects |            |    | Meets the product standard's requirements.   |
| 10.2.4 Resistance to ultra-violet (UV) radiation   |            |    | Meets the product standard's requirements.   |
| 10.2.5 Lifting   |            |    | Does not apply, since the entire switchgear needs to be evaluated.   |
| 10.2.6 Mechanical impact   |            |    | Does not apply, since the entire switchgear needs to be evaluated.   |
| 10.2.7 Inscriptions  |            |    | Meets the product standard's requirements.   |
| 10.3 Degree of protection of ASSEMBLIES  |            |    | Does not apply, since the entire switchgear needs to be evaluated.   |
| 10.4 Clearances and creepage distances   |            |    | Meets the product standard's requirements.   |
| 10.5 Protection against electric shock   |            |    | Does not apply, since the entire switchgear needs to be evaluated.   |
| 10.6 Incorporation of switching devices and components   |            |    | Does not apply, since the entire switchgear needs to be evaluated.   |
| 10.7 Internal electrical circuits and connections  |            |    | Is the panel builder's responsibility.   |
| 10.8 Connections for external conductors   |            |    | Is the panel builder's responsibility.   |
| 10.9 Insulation properties   |            |    |  |
| 10.9.2 Power-frequency electric strength   |            |    | Is the panel builder's responsibility.   |
| 10.9.3 Impulse withstand voltage   |            |    | Is the panel builder's responsibility.   |
| 10.9.4 Testing of enclosures made of insulating material   |            |    | Is the panel builder's responsibility.   |
| 10.10 Temperature rise   |            |    | The panel builder is responsible for the temperature rise calculation. Eaton will provide heat dissipation data for the devices. |
| 10.11 Short-circuit rating   |            |    | Is the panel builder's responsibility. The specifications for the switchgear must be observed.                                   |
| 10.12 Electromagnetic compatibility  |            |    | Is the panel builder's responsibility. The specifications for the switchgear must be observed.                                   |
| 10.13 Mechanical function  |            |    | The device meets the requirements, provided the information in the instruction leaflet (IL) is observed.                         |

### Technical data ETIM 7.0

## Low-voltage industrial components (EG000017) / Motor protection circuit-breaker (EC000074)

Electric engineering, automation, process control engineering / Low-voltage switch technology / Circuit breaker (LV &lt; 1 kV) / Motor protection circuit-breaker (ecl@ss10.0.1-27-37-04-01 [AGZ529016])

|  |    |  |
|--|----|--|
| Overload release current setting                                   | A  | 0.63 - 1                                 |
| Adjustment range undelayed short-circuit release                   | A  | 15.5 - 15.5                              |
| With thermal protection  |    | Yes                                      |
| Phase failure sensitive  |    | Yes                                      |
| Switch off technique   |    | Thermomagnetic                           |
| Rated operating voltage  | V  | 690 - 690                                |
| Rated permanent current I <sub>u</sub>                             | A  | 1  |
| Rated operation power at AC-3, 230 V                               | kW | 0.12                                     |
| Rated operation power at AC-3, 400 V                               | kW | 0.25                                     |
| Type of electrical connection of main circuit                      |    | Screw connection                         |
| Type of control element  |    | Turn button                              |
| Device construction  |    | Built-in device fixed built-in technique |
| With integrated auxiliary switch                                   |    | No                                       |
| With integrated under voltage release                              |    | No                                       |
| Number of poles  |    | 3  |
| Rated short-circuit breaking capacity I <sub>cu</sub> at 400 V, AC | kA | 150                                      |
| Degree of protection (IP)  |    | IP20                                     |
| Height   | mm | 93                                       |
| Width  | mm | 45                                       |
| Depth  | mm | 76                                       |

## Approvals

|                                      |  |  |
|--------------------------------------|--|--|
| Product Standards                    |  | IEC/EN 60947-4-1; UL 60947-4-1; CSA - C22.2 No. 60947-4-1-14; CE marking                 |
| UL File No.                          |  | E36332   |
| UL Category Control No.              |  | NLRV   |
| CSA File No.                         |  | 165628   |
| CSA Class No.                        |  | 3211-05  |
| North America Certification          |  | UL listed, CSA certified   |
| Specially designed for North America |  | No   |
| Suitable for                         |  | Branch circuit: Manual type E if used with terminal, or suitable for group installations |

Characteristics

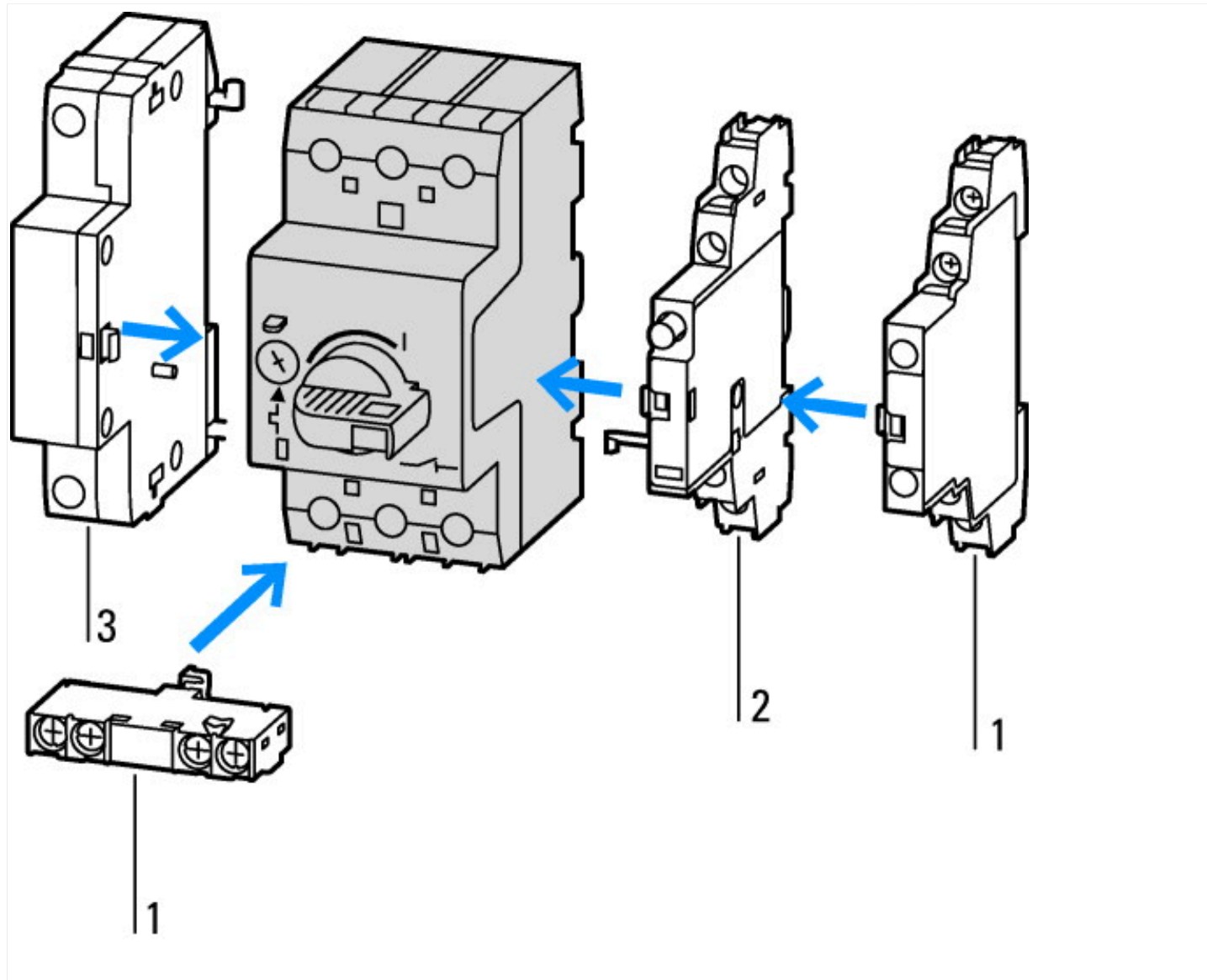

- 1: Standard auxiliary contact
- 2: Trip-indicating auxiliary contact
- 3: Shunt releases, undervoltage releases

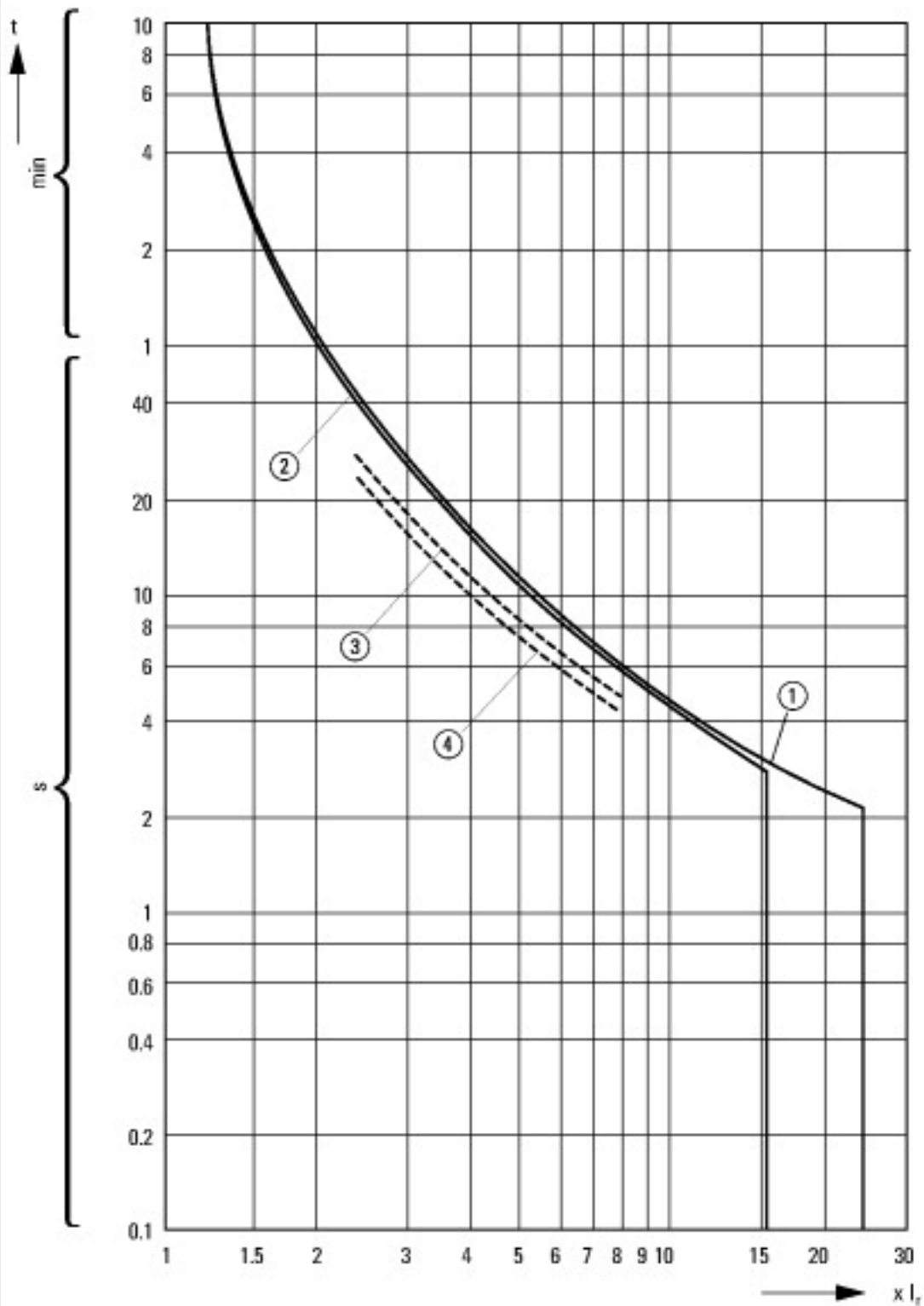

Tripping characteristics motor circuit breaker PKZM0-..., PKZM01  
 1: Minimum level, 3-phase  
 2: Maximum level, 3-phase  
 3: Minimum marker, 2-phase  
 4: Highest marker, 2-phase

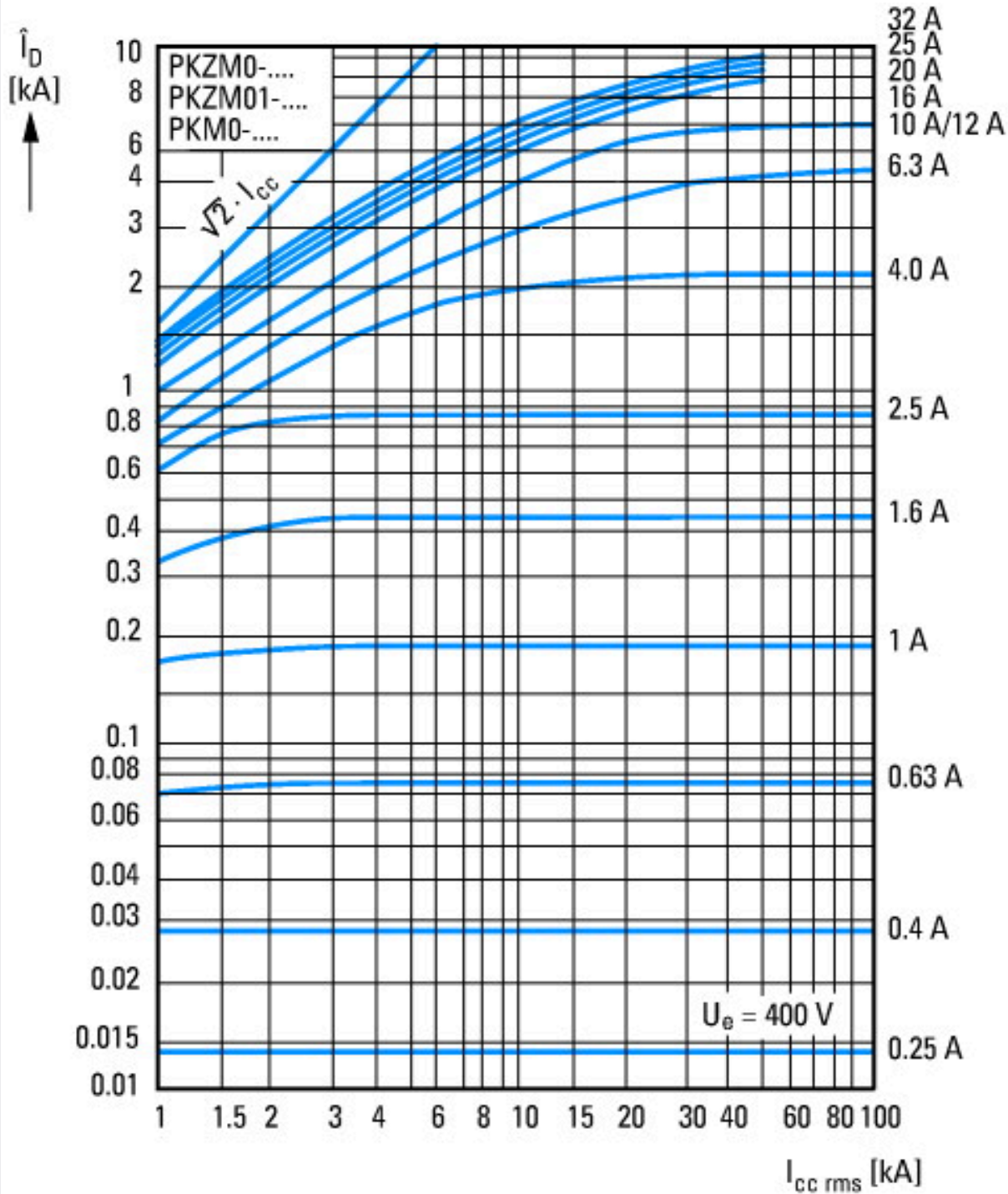

Let-through current

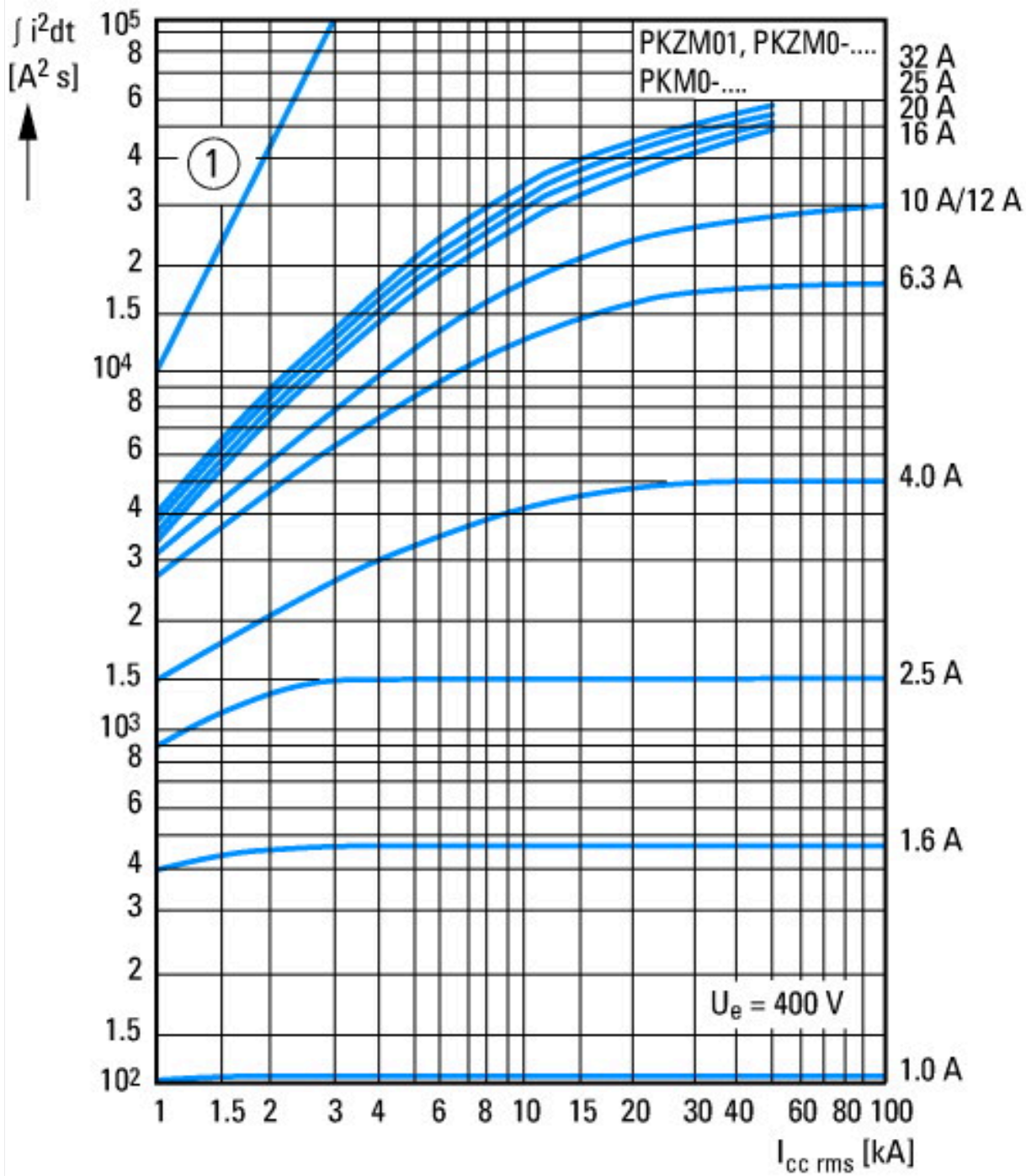

① 1 half-cycle  
Let-through energy

**Dimensions**

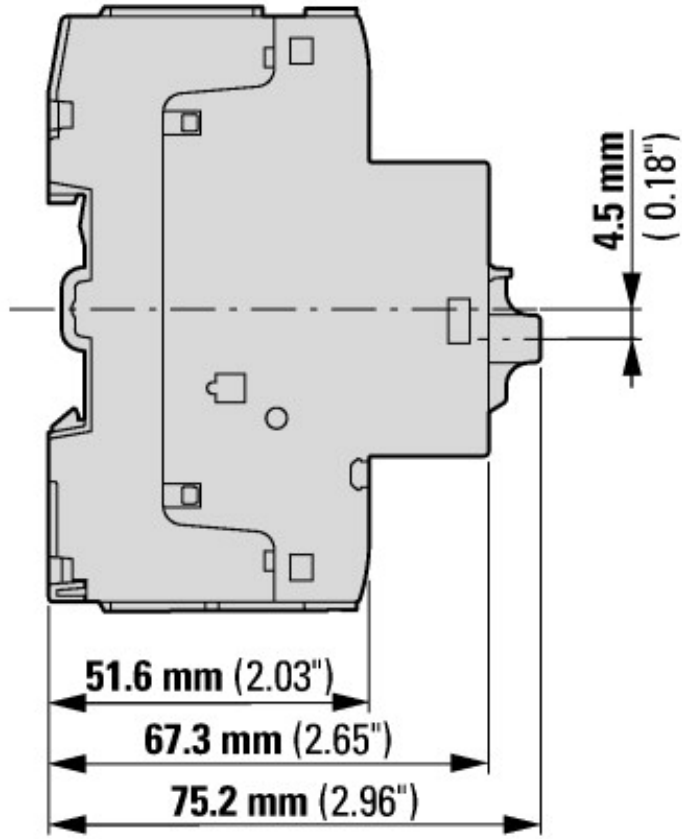
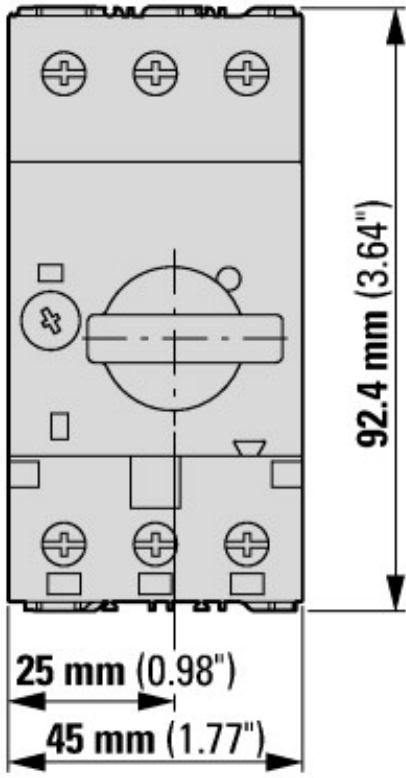

Motor-protective circuit-breaker with standard auxiliary contact  
 PKZM0-...(+NHI-E-...-PKZ0)  
 PKZM0-...-T(+NHI-E-...-PKZ0)  
 PKM0-...(+NHI-E-...-PKZ0)

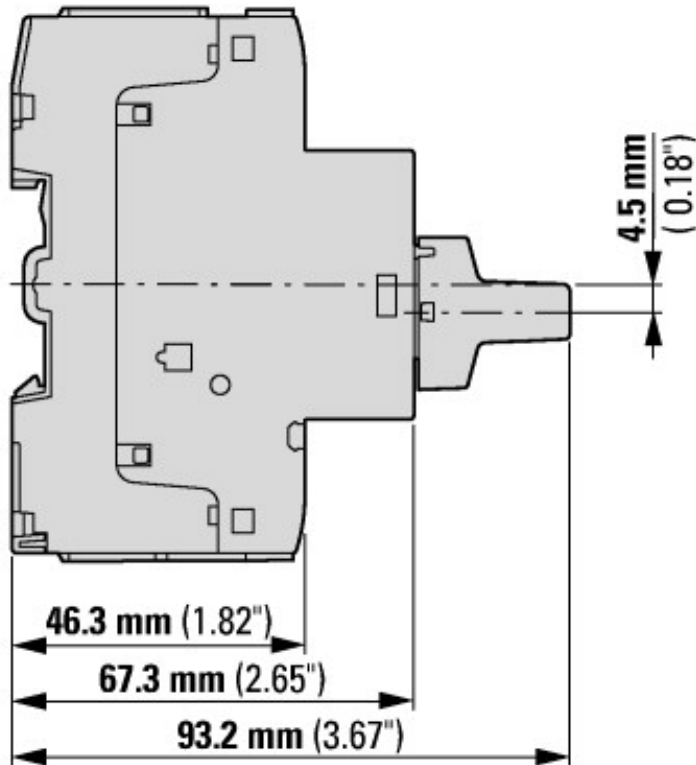
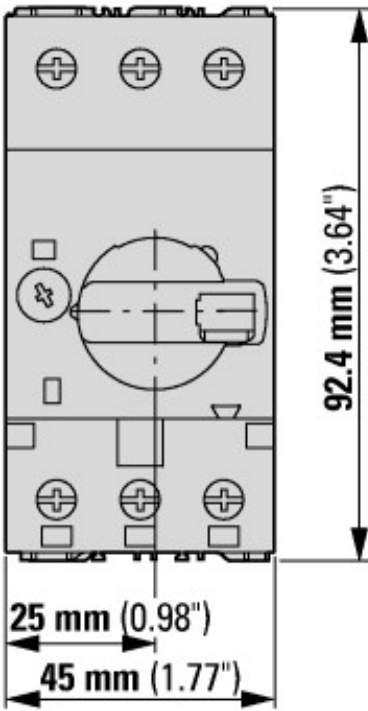

Motor-protective circuit-breakers with lockable rotary handles  
 PKZM0-...+AK-PKZ0

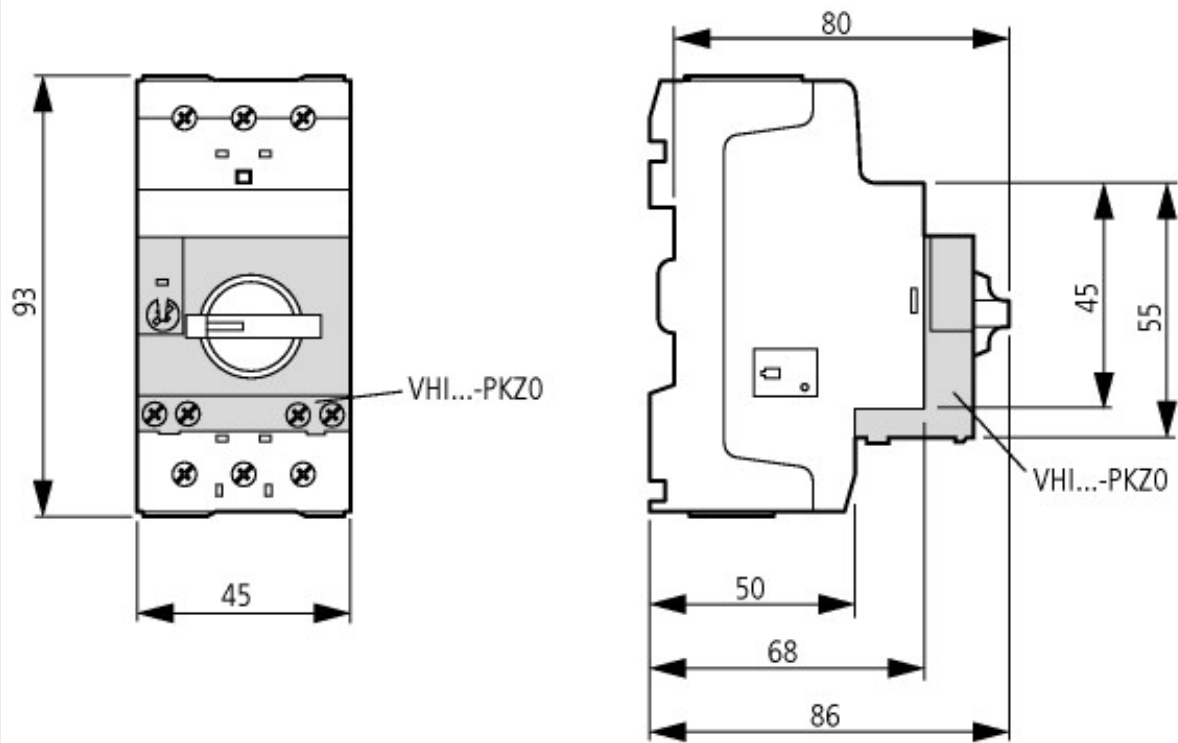

Motor-protective circuit-breakers with early-make auxiliary contacts  
PKZM0-...+VHI-...-PKZ0



# SCATTERGOOD & JOHNSON LTD

ELECTRICAL ENGINEERING & FLUID CONTROL DISTRIBUTORS

Est.1899

At Scattergood & Johnson Ltd, we pride ourselves on being a technical distributor to specialist industries.

Working with a range of quality product suppliers across a number of specialist markets, we are not your average 'box shifter' - we are your technical and supply chain partner.

We fully support every product we sell - for free! Our internal team and external sales engineers can answer any product or application question, no matter the complexity.

Backing up this technical ability is a range of 50,000+ products available from stock for nationwide next day delivery (same day if required!), or you can collect what you need from any of our trade counters around the UK.

Select your specialist interest below to learn more about how we can help.



Online, In Branch and On the Road - Scattergood & Johnson Ltd, there when you need us.

# [www.scatts.co.uk](http://www.scatts.co.uk)