

NI4-M12-VP6X

Inductive sensor

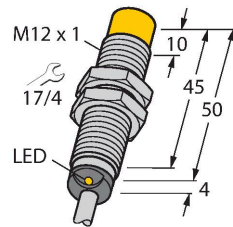

Features

- M12 × 1 threaded barrel
- Chrome-plated brass
- DC 4-wire, 10...30 VDC
- Changeover contact, PNP output
- Cable connection

Wiring diagram

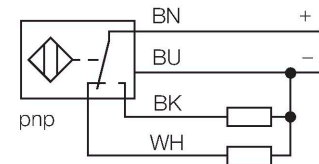

Technical data

Type	NI4-M12-VP6X
Ident. no.	16304
Rated switching distance	4 mm
Mounting conditions	Non-flush
Secured operating distance	≤ (0,81 × S _n) mm
Correction factors	St37 = 1; Al = 0.3; stainless steel = 0.7; Ms = 0.4
Repeat accuracy	≤ 2 % of full scale
Temperature drift	≤ ± 10 %
Hysteresis	3...15 %
Ambient temperature	-25...+70 °C
Operating voltage	10...30 VDC
Residual ripple	≤ 10 % U _{ss}
DC rated operational current	≤ 200 mA
No-load current	≤ 15 mA
Residual current	≤ 0.1 mA
Isolation test voltage	≤ 0.5 kV
Short-circuit protection	yes / Cyclic
Voltage drop at	≤ 1.8 V
Wire breakage/Reverse polarity protection	yes / Complete
Output function	4-wire, Complementary contact, PNP
Switching frequency	2 kHz
Design	Threaded barrel, M12 × 1
Dimensions	54 mm
Housing material	Metal, CuZn, Chrome-plated

Functional principle

Inductive sensors detect metal objects contactless and wear-free. For this, they use a high-frequency electromagnetic AC field that interacts with the target. Inductive sensors generate this field via an RLC circuit with a ferrite coil.

Technical data

Active area material	Plastic, PA12-GF30
End cap	Plastic, EPTR
Max. tightening torque housing nut	10 Nm
Electrical connection	Cable
Cable quality	Ø 5.2 mm, Gray, LifYY, PVC, 2 m
Core cross-section	4 x 0.34 mm ²
Vibration resistance	55 Hz (1 mm)
Shock resistance	30 g (11 ms)
Protection class	IP67
MTTF	2283 years acc. to SN 29500 (Ed. 99) 40 °C
Switching state	LED, Yellow

Mounting instructions

Mounting instructions/Description

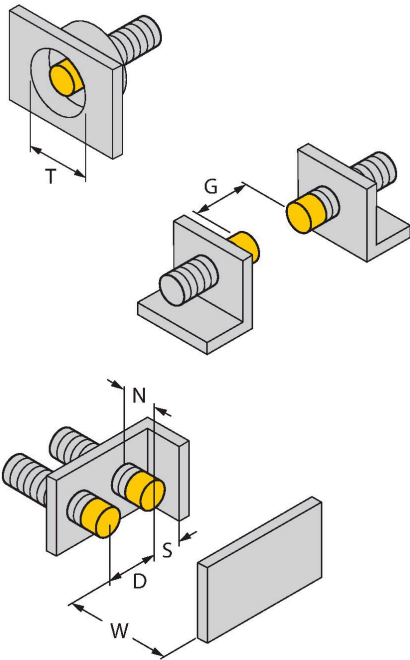

Distance D	3 x B
Distance T	45 mm
Distance S	6 mm
Distance N	2 x Sn
Diameter active area B	Ø 12 mm

Accessories

QM-12

6945101

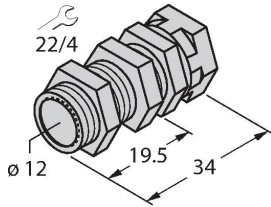

Quick-mount bracket with dead-stop; material: Chrome-plated brass. Male thread M16 × 1. Note: The switching distance of the proximity switches may change when using quick-mount brackets.

BST-12B

6947212

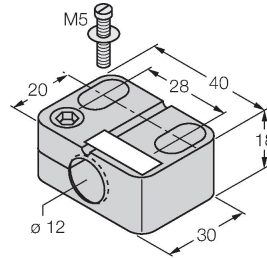

Mounting clamp for threaded barrel sensors, with dead-stop; material: PA6

MW12

6945003

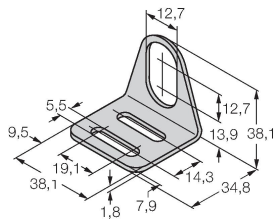

Mounting bracket for threaded barrel sensors; material: Stainless steel A2 1.4301 (AISI 304)

BSS-12

6901321

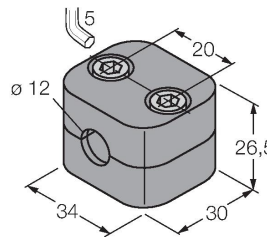

Mounting clamp for smooth and threaded barrel sensors; material: Polypropylene



SCATTERGOOD & JOHNSON LTD

ELECTRICAL ENGINEERING & FLUID CONTROL DISTRIBUTORS

Est.1899

At Scattergood & Johnson Ltd, we pride ourselves on being a technical distributor to specialist industries.

Working with a range of quality product suppliers across a number of specialist markets, we are not your average 'box shifter' - we are your technical and supply chain partner.

We fully support every product we sell - for free! Our internal team and external sales engineers can answer any product or application question, no matter the complexity.

Backing up this technical ability is a range of 50,000+ products available from stock for nationwide next day delivery (same day if required!), or you can collect what you need from any of our trade counters around the UK.

Select your specialist interest below to learn more about how we can help.



Online, In Branch and On the Road - Scattergood & Johnson Ltd, there when you need us.

www.scatts.co.uk