

# SI15-K30-AZ3

## Inductive sensor – Slot-type

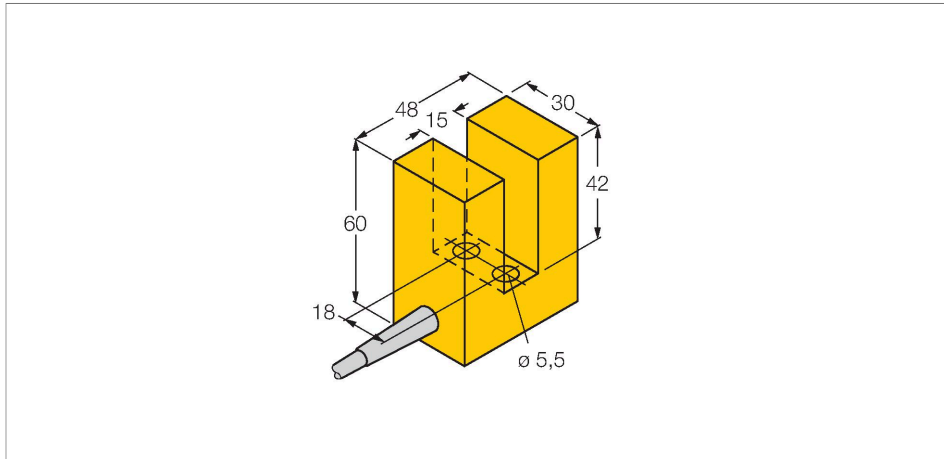

### Features

- Height 30mm
- Plastic, PBT-GF30-V0
- AC 2-wire, 20...250 VAC
- DC 2-wire, 10...300 VDC
- NO contact
- Cable connection

### Wiring diagram

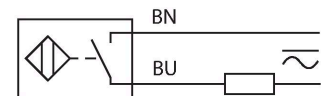

### Technical data

Type	SI15-K30-AZ3
Ident. no.	13069
Slot width	15 mm
Repeat accuracy	≤ 2 % of full scale
Temperature drift	≤ ± 10 %
Hysteresis	3...15 %
Ambient temperature	-25...+70 °C
Operating voltage	20...250 VAC
Operating voltage	10...300 VDC
AC rated operational current	≤ 400 mA
DC rated operational current	≤ 300 mA
Frequency	≥ 50...≤ 60 Hz
Residual current	≤ 1.7 mA
Isolation test voltage	≤ 1.5 kV
Surge current	≤ 8 A (≤ 10 ms max. 5 Hz)
Voltage drop at I <sub>e</sub>	≤ 6 V
Output function	2-wire, NO contact
Smallest operating current	≥ 3 mA
Switching frequency	0.02 kHz
Design	Slot sensor, K30
Dimensions	48 x 60 x 30 mm
Housing material	Plastic, PBT-GF30-V0
Active area material	Plastic, PBT-GF30-V0
Electrical connection	Cable

### Functional principle

Inductive sensors detect metal objects contactless and wear-free. For this purpose they use a high-frequency electromagnetic AC field that interacts with the target. The sensors hosting a ferrite core coil generate the AC field through an LC resonant circuit.

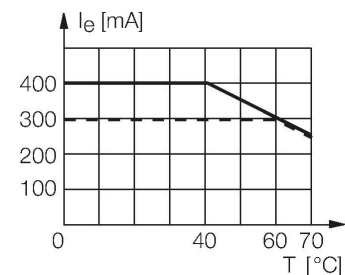

## Technical data

Cable quality	Ø 5.2 mm, LifYY, PVC, 2 m
Core cross-section	2 x 0.34 mm <sup>2</sup>
Vibration resistance	55 Hz (1 mm)
Shock resistance	30 g (11 ms)
Protection class	IP67
MTTF	2283 years acc. to SN 29500 (Ed. 99) 40 °C

## Mounting instructions

### Mounting instructions/Description

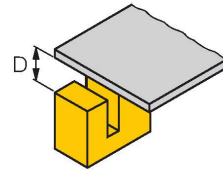
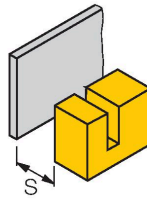
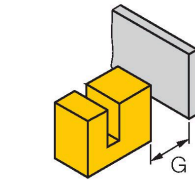
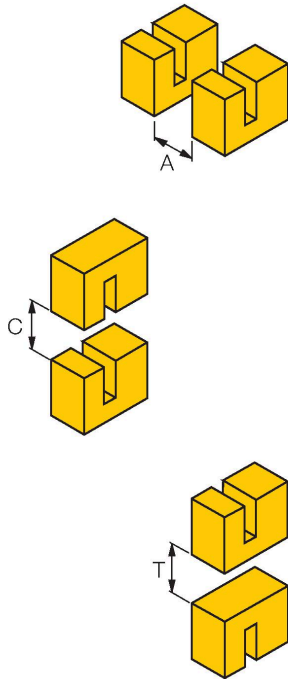

Distance D	5 mm
Distance T	10 mm
Distance S	5 mm
Distance G	5 mm
Distance A	30 mm
Distance C	30 mm



# SCATTERGOOD & JOHNSON LTD

ELECTRICAL ENGINEERING & FLUID CONTROL DISTRIBUTORS

Est.1899

At Scattergood & Johnson Ltd, we pride ourselves on being a technical distributor to specialist industries.

Working with a range of quality product suppliers across a number of specialist markets, we are not your average 'box shifter' - we are your technical and supply chain partner.

We fully support every product we sell - for free! Our internal team and external sales engineers can answer any product or application question, no matter the complexity.

Backing up this technical ability is a range of 50,000+ products available from stock for nationwide next day delivery (same day if required!), or you can collect what you need from any of our trade counters around the UK.

Select your specialist interest below to learn more about how we can help.



Online, In Branch and On the Road - Scattergood & Johnson Ltd, there when you need us.

# [www.scatts.co.uk](http://www.scatts.co.uk)