

EURONORD P 080806



Sample photo

Order symbol: P 080806
Product nbr: 7094140
Description: Enclosure
Remarks: Polyester

EAN: 6418074004338
EI. number:
 Finland: 3423655
 Electric No. 8212005604
 Denmark:
 Electric No. Italy: 7331010
 Electric No. Sweden: 2536205

Including: Base, cover with EPDM gasket and stainless steel cover screws.

Dimensions:				Rating:
	Length	Width	Height	
mm:	80	75	55	Ingress Protection (EN 60529): IP66
inch:	3.1	3.0	2.2	Impact Resistance (EN 62262): IK08
Materials:				Electrical insulation: Totally insulated
Material:	Polyester			Halogen free (DIN/VDE 0472, Part 815): 1
Base colour:	RAL 7001			UV resistance: UL 508
Cover screws material:	Stainless steel			Flammability Rating: UL 94 V0
Cover colour:	RAL 7001			Glow Wire Test (IEC 695-2-1) °C: 960
Gasket material:	EPDM			NEMA Class: NEMA 1, 4, 4X, 12, 13
Temperatures:				
Temperature °C (short term):	-50 ... 120 °C			
Temperature °C (continuous):	-40 ... 80 °C			
Temperature °F (short term):	-60 ... 250 °F			
Temperature °F (continuous):	-40 ... 175 °F			

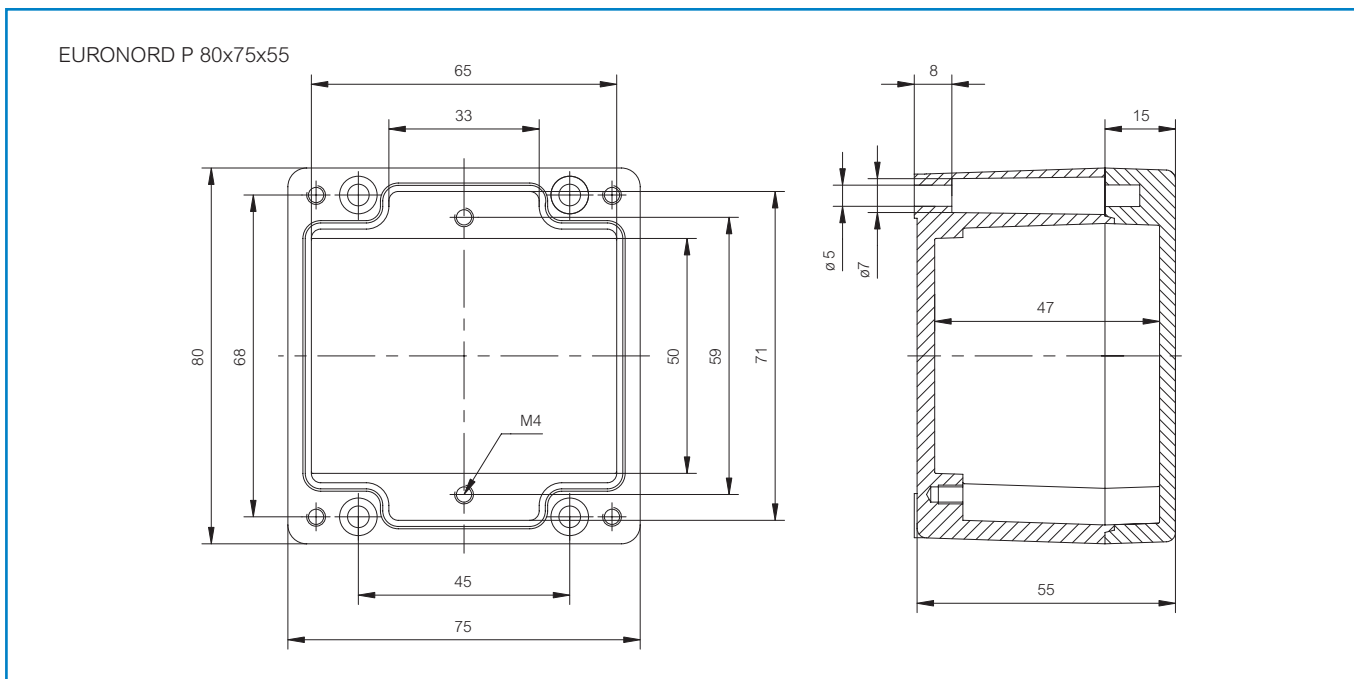



SCATTERGOOD & JOHNSON LTD

ELECTRICAL ENGINEERING & FLUID CONTROL DISTRIBUTORS

Est.1899

At Scattergood & Johnson Ltd, we pride ourselves on being a technical distributor to specialist industries.

Working with a range of quality product suppliers across a number of specialist markets, we are not your average 'box shifter' - we are your technical and supply chain partner.

We fully support every product we sell - for free! Our internal team and external sales engineers can answer any product or application question, no matter the complexity.

Backing up this technical ability is a range of 50,000+ products available from stock for nationwide next day delivery (same day if required!), or you can collect what you need from any of our trade counters around the UK.

Select your specialist interest below to learn more about how we can help.



Online, In Branch and On the Road - Scattergood & Johnson Ltd, there when you need us.

www.scatts.co.uk