

Data sheet | Item number: 750-306
Fieldbus Coupler DeviceNet; light gray

www.wago.com/750-306

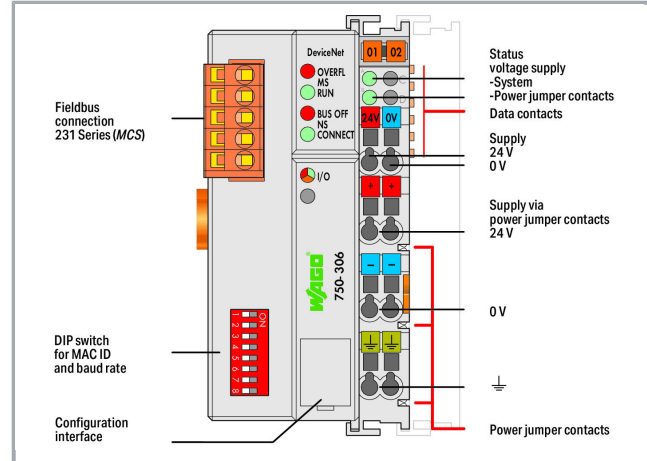
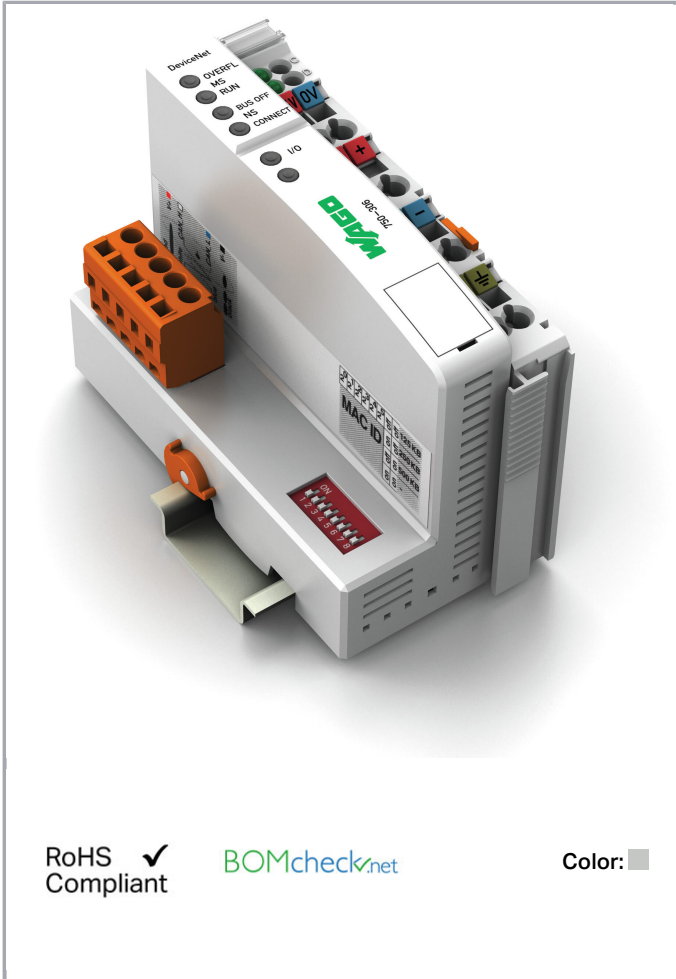

RoHS Compliant

BOMcheck.net

Color:

Subject to changes. Please also observe the further product documentation!

WAGO Kontakttechnik GmbH & Co. KG
 Hansastr. 27
 32423 Minden
 Phone: +49571 887-0 | Fax: +49571 887-169
 Email: info.de@wago.com | Web: www.wago.com

Do you have any questions about our products?
 We are always happy to take your call at 01788 568 008.

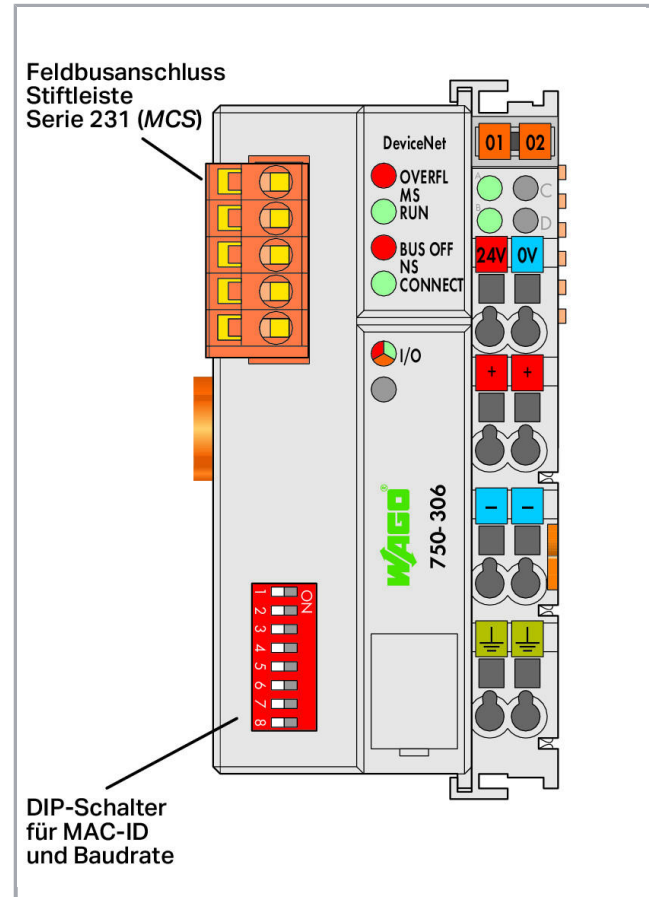
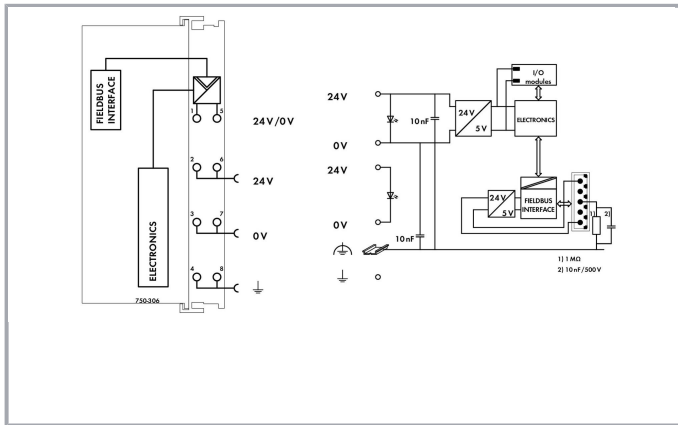
Data sheet | Item number: 750-306www.wago.com/750-306**Item description**

This fieldbus coupler connects the WAGO I/O System as a slave to the DeviceNet fieldbus.

The fieldbus coupler detects all connected I/O modules and creates a local process image. Analog and specialty module data is sent via words and /or bytes; digital data is sent bit by bit.

The process image can be transferred via the DeviceNet fieldbus to the memory of the control system.

The local process image is divided into two data zones containing the data received and the data to be sent. The process data can be sent via the DeviceNet™ to a control system for further processing. The process output data is sent via DeviceNet™.

The data of the analog modules is stored in the process image that is created automatically according to the order in which the modules are connected to the coupler. The bits of the digital modules are sent byte by byte and added to the analog data. If the amount of digital I/O information exceeds eight bits, the coupler automatically starts with a new byte.

Note:

Note: Configuration files required (EDS)!

Subject to changes. Please also observe the further product documentation!

WAGO Kontakttechnik GmbH & Co. KG
 Hansastr. 27
 32423 Minden
 Phone: +49571 887-0 | Fax: +49571 887-169
 Email: info.de@wago.com | Web: www.wago.com

Do you have any questions about our products?
 We are always happy to take your call at 01788 568 008.

Data sheet | Item number: 750-306www.wago.com/750-306**Data****Technical Data**

Communication	DeviceNet
Number of fieldbus nodes on master (max.)	64
Number of I/O points	6,000
Baud rate	500 kBd (125 kBd, 250 kBd, 500 kBd)
Bus segment length (max.)	500 m
Transmission medium	Shielded Cu cable; Remote bus cable: 2 x 0.82 mm ² + 2 x 1.7 mm ² ; Drop cable: 2 x 0.2 mm ² + 2 x 0.32 mm ²
Number of modules per node (max.)	64
DeviceNet features	Polled I/O message connection Strobed I/O message connection Change of state Cyclic message connection Group 2 only Slave
Input and output (fieldbus) process image (max.)	512 Byte/512 Byte
Supply voltage (system)	DC 24 V(-25 ... +30 %); via pluggable connector (CAGE CLAMP [®] connection)
Power consumption (5 V system supply)	350 mA
Total current (system supply)	1,650 mA
Supply voltage (field)	DC 24 V (-25 ... +30 %); via power jumper contacts
Input current via DeviceNet interface at 11 V	120 mA
Input current (typ.) at nominal load (24 V)	500 mA
Power supply efficiency (typ.) at nominal load (24 V)	87 %
Isolation	500 V system/field
Number of outgoing power jumper contacts	3
Current carrying capacity (power jumper contacts)	10 A
Certification	ODVA

Connection data

Connection technology: communication/fieldbus	DeviceNet: 1 x Male connector; 5-pole
Connection technology: field supply	6 x CAGE CLAMP [®]
Connection technology: system supply	2 x CAGE CLAMP [®]
Connection technology: Device configuration	1 x Male connector; 4-pole
Connection type (1)	System/field supply
Solid conductor	0.08 ... 2.5 mm ² / 28 ... 14 AWG
Fine-stranded conductor	0.08 ... 2.5 mm ² / 28 ... 14 AWG

Subject to changes. Please also observe the further product documentation!

WAGO Kontakttechnik GmbH & Co. KG
 Hansastr. 27
 32423 Minden
 Phone: +49571 887-0 | Fax: +49571 887-169
 Email: info.de@wago.com | Web: www.wago.com

Do you have any questions about our products?
 We are always happy to take your call at 01788 568 008.

Data sheet | Item number: 750-306www.wago.com/750-306

Strip length	8 ... 9 mm / 0.31 ... 0.35 inch
--------------	---------------------------------

Geometrical Data

Width	50.5 mm / 1.988 inch
Height	100 mm / 3.937 inch
Depth	71.1 mm / 2.799 inch
Depth from upper edge of DIN-rail	63.9 mm / 2.516 inch

Mechanical data

Mounting type	DIN-35 rail
---------------	-------------

Material Data

Color	light gray
Housing material	Polycarbonate, polyamide 6.6
Fire load	3.073 MJ
Weight	200 g
Conformity marking	CE

Environmental Requirements

Surrounding air temperature (operation)	0 ... 55 °C
Surrounding air temperature (storage)	-40 ... 85 °C
Protection type	IP20
Pollution degree (5)	2 per IEC 61131-2
Operating altitude	0 ... 2000 m
Mounting position	horizontal (standing/lying); vertical
Relative humidity (without condensation)	95 %
Vibration resistance	4g per IEC 60068-2-6
Shock resistance	15g per IEC 60068-2-27
EMC immunity to interference	per EN 61000-6-2, marine applications
EMC emission of interference	per EN 61000-6-4, marine applications
Exposure to pollutants	Per IEC 60068-2-42 and IEC 60068-2-43
Permissible H ₂ S contaminant concentration at a relative humidity 75 %	10 ppm
Permissible SO ₂ contaminant concentration at a relative humidity 75 %	25 ppm

Subject to changes. Please also observe the further product documentation!

WAGO Kontakttechnik GmbH & Co. KG
 Hansastr. 27
 32423 Minden
 Phone: +49571 887-0 | Fax: +49571 887-169
 Email: info.de@wago.com | Web: www.wago.com

Do you have any questions about our products?
 We are always happy to take your call at 01788 568 008.

Data sheet | Item number: 750-306



www.wago.com/750-306

Commercial data

Product Group	15 (Remote I/O)
Packaging type	BOX
Country of origin	DE
GTIN	4045454526542
Customs tariff number	85176200000

Approvals / Certificates

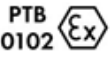
Ex-Approvals

Logo	Approval	Additional Approval Text	Certificate name
	ATEX TUEV Nord Cert GmbH	EN 60079-0	TÜV 07 ATEX 554086 X en.
	TUEV Nord TUEV Nord Cert GmbH	IEC 60079-0	IECEX TUN 09.0001 X
	UL Underwriters Laboratories Inc. (HAZARDOUS LOCATIONS)	UL 121201	E198726 Sec.1

Country specific Approvals

Logo	Approval	Additional Approval Text	Certificate name
	KC National Radio Research Agency	Article 58-2, Clause 3	MSIP- REM-W43- FBC750

Ship Approvals

Logo	Approval	Additional Approval Text	Certificate name
	ABS American Bureau of Shipping	-	19- HG1821926
	BV Bureau Veritas S.A.	-	13453/DO BV







Subject to changes. Please also observe the further product documentation!

WAGO Kontakttechnik GmbH & Co. KG
Hansastr. 27
32423 Minden
Phone: +49571 887-0 | Fax: +49571 887-169
Email: info.de@wago.com | Web: www.wago.com

Do you have any questions about our products?
We are always happy to take your call at 01788 568 008.

Data sheet | Item number: 750-306

www.wago.com/750-306

	DNV GL Det Norske Veritas, Germanischer Lloyd	-	TAA0000194
			
	KR Korean Register of Shipping	-	KR HMB05880- AC001
	LR Lloyds Register	-	02/20026 (E6)
	NK Nippon Kaiji Kyokai	-	TA17255M
	PRS Polski Rejestr Statków	-	TE/2236 /880590/19
	RINA RINA Germany GmbH	-	ELE066419XG

UL-Approvals

Logo	Approval	Additional Approval Text	Certificate name
	UL UL International Netherlands B.V. (ORDINARY LOCATIONS)	UL 508	E175199 Sec.1

Product family

750/753 Series – I/O System
[Show all products from the family](#)

Subject to changes. Please also observe the further product documentation!

WAGO Kontakttechnik GmbH & Co. KG
 Hansastr. 27
 32423 Minden
 Phone: +49571 887-0 | Fax: +49571 887-169
 Email: info.de@wago.com | Web: www.wago.com

Do you have any questions about our products?
 We are always happy to take your call at 01788 568 008.



SCATTERGOOD & JOHNSON LTD

ELECTRICAL ENGINEERING & FLUID CONTROL DISTRIBUTORS

Est.1899

At Scattergood & Johnson Ltd, we pride ourselves on being a technical distributor to specialist industries.

Working with a range of quality product suppliers across a number of specialist markets, we are not your average 'box shifter' - we are your technical and supply chain partner.

We fully support every product we sell - for free! Our internal team and external sales engineers can answer any product or application question, no matter the complexity.

Backing up this technical ability is a range of 50,000+ products available from stock for nationwide next day delivery (same day if required!), or you can collect what you need from any of our trade counters around the UK.

Select your specialist interest below to learn more about how we can help.



Online, In Branch and On the Road - Scattergood & Johnson Ltd, there when you need us.

www.scatts.co.uk