

Data sheet | Item number: 750-502
 2-channel digital output; 24 VDC; 2.0 A; light gray

www.wago.com/750-502

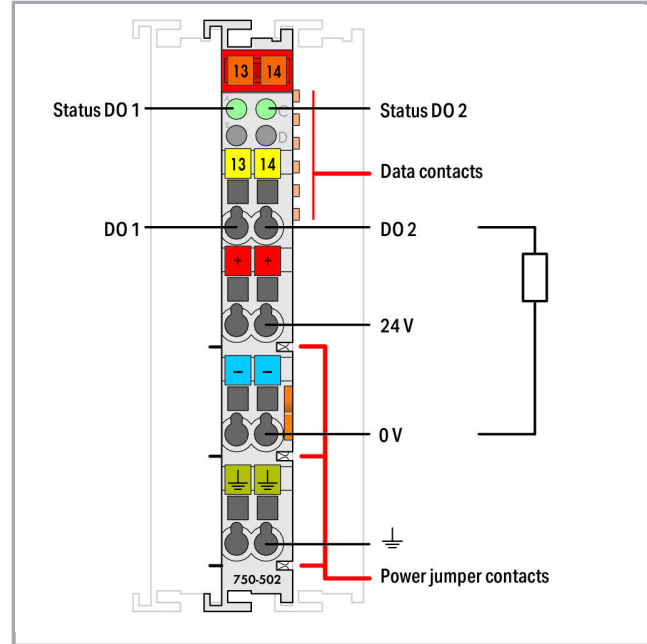
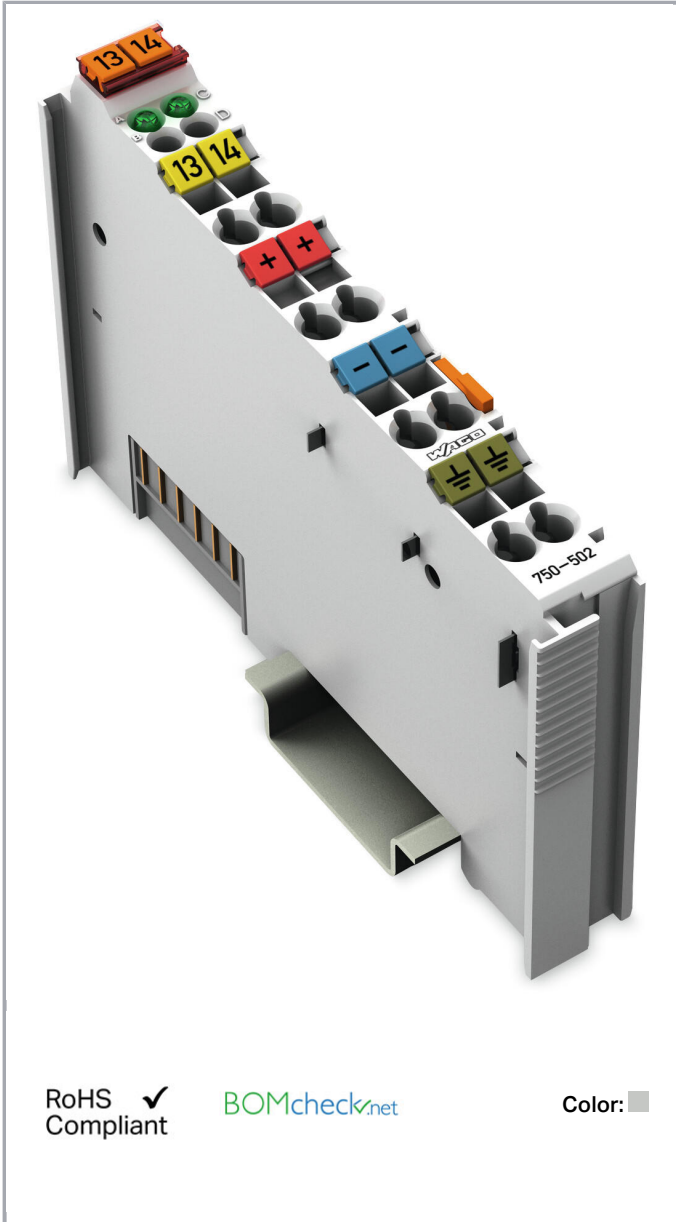

RoHS Compliant

[BOMcheck.net](https://www.bomcheck.net)

Color:

Subject to changes. Please also observe the further product documentation!

WAGO Kontakttechnik GmbH & Co. KG
 Hansastr. 27
 32423 Minden
 Phone: +49571 887-0 | Fax: +49571 887-169
 Email: info.de@wago.com | Web: www.wago.com

Do you have any questions about our products?
 We are always happy to take your call at 01788 568 008.

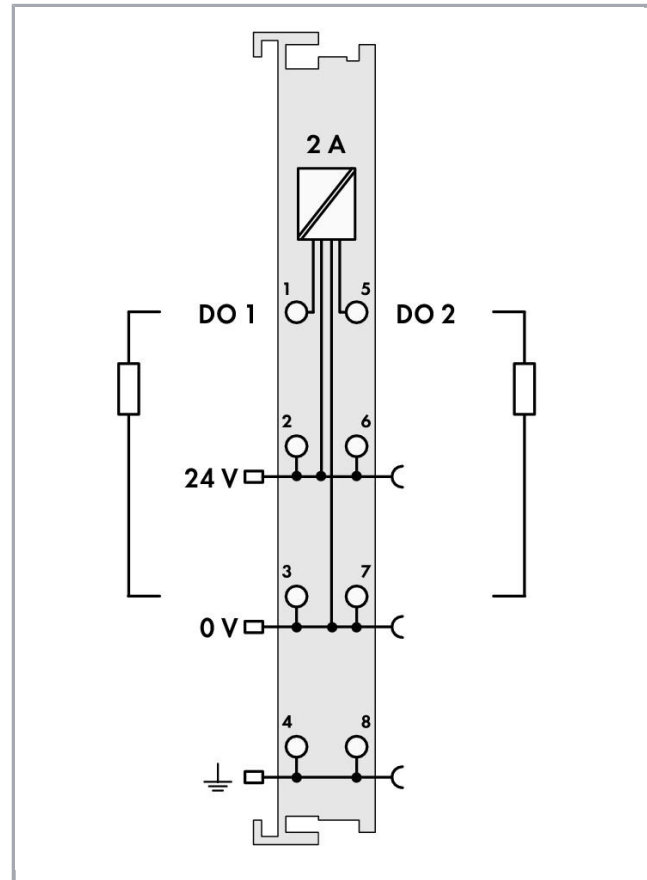
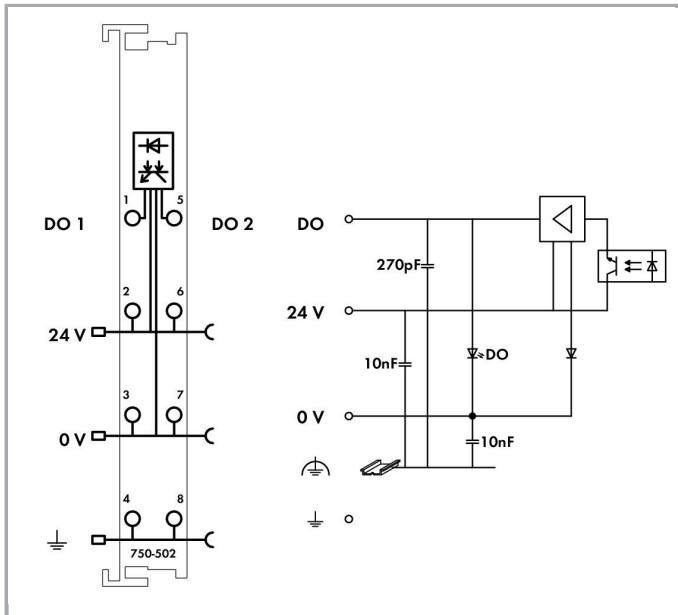
Data sheet | Item number: 750-502www.wago.com/750-502**Item description**

This digital output module transmits control signals from the automation device to the connected actuators.

All outputs are short-circuit-protected.

Field and system levels are electrically isolated.

Data**Technical Data**

Number of digital outputs	2
Total number of channels (module)	2
Signal type	Voltage
Voltage signal type	DC 24 V
Actuator connection	2 x (2-wire, 3-wire, 4-wire)
Output characteristic	high-side switching
Output current per channel	2 A

Subject to changes. Please also observe the further product documentation!

WAGO Kontakttechnik GmbH & Co. KG
 Hansastr. 27
 32423 Minden
 Phone: +49571 887-0 | Fax: +49571 887-169
 Email: info.de@wago.com | Web: www.wago.com

Do you have any questions about our products?
 We are always happy to take your call at 01788 568 008.

Data sheet | Item number: 750-502
www.wago.com/750-502

Output current	short-circuit-protected
Switching frequency (max.)	2.5 kHz
Load type	Resistive, inductive, lamp load
Short-circuit limitation (typ.) PWM	35 A
Inductive load switch-off energy dissipation (max.)	0.14 J
Output (internal) data width (max.)	2 Bit
Supply voltage (system)	DC 5 V; via data contacts
Power consumption (5 V system supply)	3.5 mA
Supply voltage (field)	DC 24 V (-25 ... +30 %); via power jumper contacts (power supply via blade contact; transmission via spring contact)
Power consumption, field supply (module with no external load)	15 mA
Isolation	500 V system/field
Indicators	LED (A, C) green: Status DO 1, DO 2
Number of incoming power jumper contacts	3
Number of outgoing power jumper contacts	3
Current carrying capacity (power jumper contacts)	10 A

Connection data

Connection technology: inputs/outputs	8 x CAGE CLAMP®
Connection type (1)	Inputs/Outputs
Solid conductor	0.08 ... 2.5 mm ² / 28 ... 14 AWG
Fine-stranded conductor	0.08 ... 2.5 mm ² / 28 ... 14 AWG
Strip length	8 ... 9 mm / 0.31 ... 0.35 inch

Geometrical Data

Width	12 mm / 0.472 inch
Height	100 mm / 3.937 inch
Depth	69.8 mm / 2.748 inch
Depth from upper edge of DIN-rail	62.6 mm / 2.465 inch

Mechanical data

Mounting type	DIN-35 rail
---------------	-------------

Material Data

Color	light gray
Housing material	Polycarbonate, polyamide 6.6

Subject to changes. Please also observe the further product documentation!

WAGO Kontakttechnik GmbH & Co. KG
 Hansastr. 27
 32423 Minden
 Phone: +49571 887-0 | Fax: +49571 887-169
 Email: info.de@wago.com | Web: www.wago.com

Do you have any questions about our products?
 We are always happy to take your call at 01788 568 008.

Data sheet | Item number: 750-502www.wago.com/750-502

Fire load	1.153 MJ
Weight	47.2 g
Conformity marking	CE

Environmental Requirements

Surrounding air temperature (operation)	0 ... 55 °C
Surrounding air temperature (storage)	-40 ... 85 °C
Protection type	IP20
Pollution degree (5)	2 per IEC 61131-2
Operating altitude	0 ... 2000 m
Mounting position	horizontal (standing/lying); vertical
Relative humidity (without condensation)	95 %
Vibration resistance	4g per IEC 60068-2-6
Shock resistance	15g per IEC 60068-2-27
EMC immunity to interference	per EN 61000-6-2, marine applications
EMC emission of interference	per EN 61000-6-4, marine applications
Exposure to pollutants	Per IEC 60068-2-42 and IEC 60068-2-43
Permissible H ₂ S contaminant concentration at a relative humidity 75 %	10 ppm
Permissible SO ₂ contaminant concentration at a relative humidity 75 %	25 ppm

Commercial data

Product Group	15 (Remote I/O)
Packaging type	BOX
Country of origin	DE
GTIN	4045454586652
Customs tariff number	85371098990

Approvals / Certificates**Ex-Approvals**

Logo	Approval	Additional Approval Text	Certificate name
	ATEX TUEV Nord Cert GmbH	EN 60079-0	TÜV 07 ATEX 554086 X en.
	TUEV Nord	IEC 60079-0	IECEX

Subject to changes. Please also observe the further product documentation!

WAGO Kontakttechnik GmbH & Co. KG
 Hansastr. 27
 32423 Minden
 Phone: +49571 887-0 | Fax: +49571 887-169
 Email: info.de@wago.com | Web: www.wago.com

Do you have any questions about our products?
 We are always happy to take your call at 01788 568 008.

Data sheet | Item number: 750-502

www.wago.com/750-502

TUEV Nord Cert GmbH

TUN
09.0001 XUL
Underwriters Laboratories Inc. (HAZARDOUS
LOCATIONS)





UL 121201

E198726
Sec.1

Country specific Approvals

Logo	Approval	Additional Approval Text	Certificate name
	KC National Radio Research Agency	Article 58-2, Clause 3	MSIP- REM-W43- DOM750

Ship Approvals

Logo	Approval	Additional Approval Text	Certificate name
	ABS American Bureau of Shipping	-	19- HG1821926
	BV Bureau Veritas S.A.	-	13453/DO BV
	DNV GL Det Norske Veritas, Germanischer Lloyd	-	TAA0000194
	KR Korean Register of Shipping	-	KR HMB05880- AC001
	LR Lloyds Register	-	02/20026 (E6)
	NK Nippon Kaiji Kyokai	-	TA17255M

Subject to changes. Please also observe the further product documentation!

WAGO Kontakttechnik GmbH & Co. KG
Hansastr. 27
32423 Minden
Phone: +49571 887-0 | Fax: +49571 887-169
Email: info.de@wago.com | Web: www.wago.com

Do you have any questions about our products?
We are always happy to take your call at 01788 568 008.

Data sheet | Item number: 750-502

www.wago.com/750-502

	PRS Polski Rejestr Statków	-	TE/2236 /880590/19
	RINA RINA Germany GmbH	-	ELE066419XG

UL-Approvals

Logo	Approval	Additional Approval Text	Certificate name
	UL UL International Netherlands B.V. (ORDINARY LOCATIONS)	UL 508	E175199 Sec.1

Product family

750/753 Series – I/O System[Show all products from the family](#)

Subject to changes. Please also observe the further product documentation!

WAGO Kontakttechnik GmbH & Co. KG
Hansastr. 27
32423 Minden
Phone: +49571 887-0 | Fax: +49571 887-169
Email: info.de@wago.com | Web: www.wago.com

Do you have any questions about our products?
We are always happy to take your call at 01788 568 008.



SCATTERGOOD & JOHNSON LTD

ELECTRICAL ENGINEERING & FLUID CONTROL DISTRIBUTORS

Est.1899

At Scattergood & Johnson Ltd, we pride ourselves on being a technical distributor to specialist industries.

Working with a range of quality product suppliers across a number of specialist markets, we are not your average 'box shifter' - we are your technical and supply chain partner.

We fully support every product we sell - for free! Our internal team and external sales engineers can answer any product or application question, no matter the complexity.

Backing up this technical ability is a range of 50,000+ products available from stock for nationwide next day delivery (same day if required!), or you can collect what you need from any of our trade counters around the UK.

Select your specialist interest below to learn more about how we can help.



Online, In Branch and On the Road - Scattergood & Johnson Ltd, there when you need us.

www.scatts.co.uk