

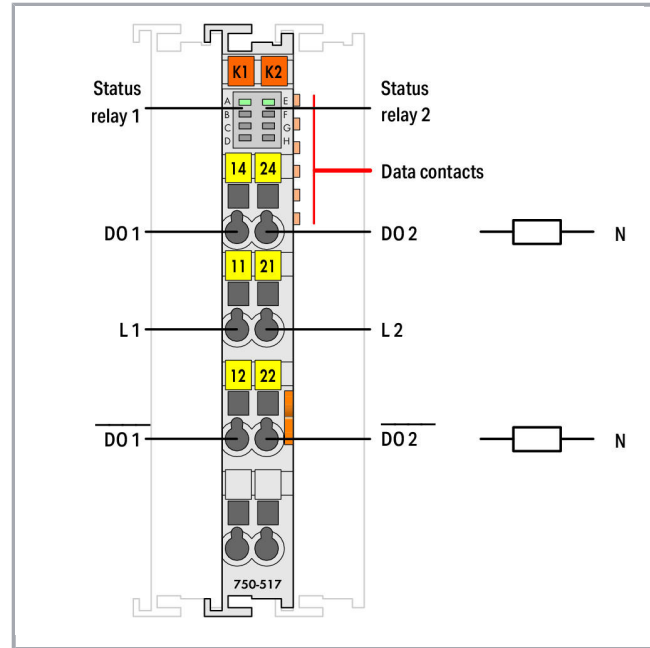

Data sheet | Item number: 750-517

2-channel relay output; AC 250 V; 1 A; Potential-free; 2 changeover contacts; light gray

www.wago.com/750-517



RoHS Compliant

BOMcheck.net

Color:

Subject to changes. Please also observe the further product documentation!

WAGO Kontakttechnik GmbH & Co. KG
 Hansastr. 27
 32423 Minden
 Phone: +49571 887-0 | Fax: +49571 887-169
 Email: info.de@wago.com | Web: www.wago.com

Do you have any questions about our products?
 We are always happy to take your call at 01788 568 008.

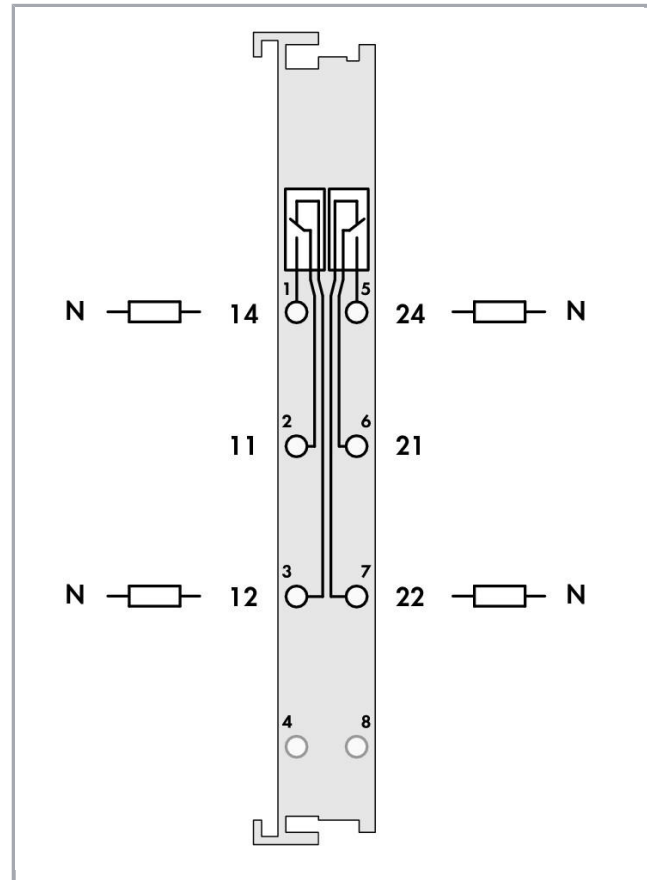
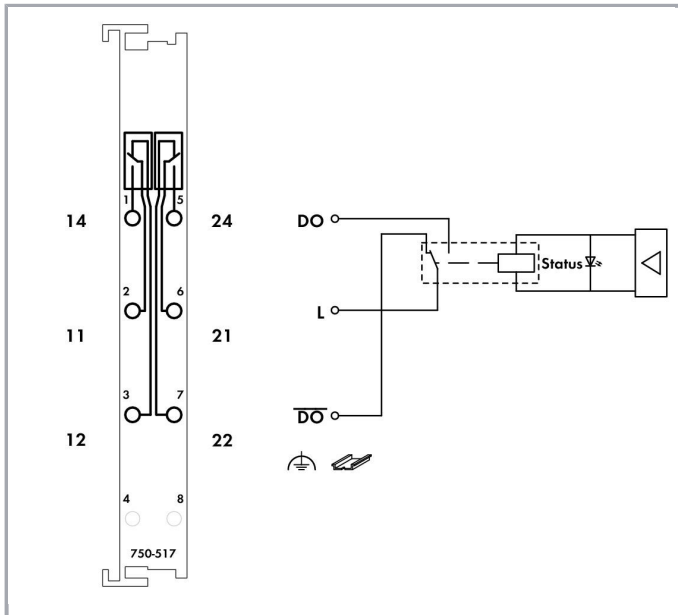
Data sheet | Item number: 750-517www.wago.com/750-517**Item description**

This digital output module transmits control signals from the automation device to the connected actuators.

The internal system voltage triggers the relay.

The NO contacts are electrically isolated.

The state of the relay is indicated by a LED.

Data**Technical Data**

Number of digital outputs	2
Total number of channels (module)	2
Actuator connection	2 x (1-wire)
Output circuit design	2 changeover contacts Relays
Output characteristic	potential-free

Subject to changes. Please also observe the further product documentation!

WAGO Kontakttechnik GmbH & Co. KG
 Hansastr. 27
 32423 Minden
 Phone: +49571 887-0 | Fax: +49571 887-169
 Email: info.de@wago.com | Web: www.wago.com

Do you have any questions about our products?
 We are always happy to take your call at 01788 568 008.

Data sheet | Item number: 750-517www.wago.com/750-517

Switching frequency (max.)	0.1 Hz; Nominal load
Load type of switching frequency	Nominal load
Switching voltage (max.)	250 VAC, 300 VDC V
Switching current (max.)	1 A
Switching current (note)	1 A at 250 VAC and 40 VDC; 0.15 A at 300 VDC
Switching voltage (min.)	12 V
Switching current (min.)	100 mA
Pull-in time (max.)	8 ms
Drop-out time (max.)	4 ms
Electrical switching operations (min.) (at max. resistive load)	10
Mechanical switching operations (min.) (at max. resistive load)	5
Output (internal) data width (max.)	2 Bit
Supply voltage (system)	DC 5 V; via data contacts
Power consumption (5 V system supply)	90 mA
Isolation	1500 V (system/field)
Indicators	LED (A, E) green: Status relay 1, relay 2

Connection data

Connection technology: inputs/outputs	8 x CAGE CLAMP®
Connection type (1)	Inputs/Outputs
Solid conductor	0.08 ... 2.5 mm ² / 28 ... 14 AWG
Fine-stranded conductor	0.08 ... 2.5 mm ² / 28 ... 14 AWG
Strip length	8 ... 9 mm / 0.31 ... 0.35 inch

Geometrical Data

Width	12 mm / 0.472 inch
Height	100 mm / 3.937 inch
Depth	67.8 mm / 2.669 inch
Depth from upper edge of DIN-rail	60.6 mm / 2.386 inch

Mechanical data

Mounting type	DIN-35 rail
---------------	-------------

Material Data

Color	light gray
Contact material	Ag alloy

Subject to changes. Please also observe the further product documentation!

WAGO Kontakttechnik GmbH & Co. KG
 Hansastr. 27
 32423 Minden
 Phone: +49571 887-0 | Fax: +49571 887-169
 Email: info.de@wago.com | Web: www.wago.com

Do you have any questions about our products?
 We are always happy to take your call at 01788 568 008.

Data sheet | Item number: 750-517www.wago.com/750-517

Housing material	Polycarbonate, polyamide 6.6
Fire load	1.394 MJ
Weight	52.4 g
Conformity marking	CE

Environmental Requirements

Surrounding air temperature (operation)	0 ... 55 °C
Surrounding air temperature (storage)	-40 ... 85 °C
Protection type	IP20
Pollution degree (5)	2 per IEC 61131-2
Operating altitude	0 ... 2000 m
Mounting position	horizontal (standing/lying); vertical
Relative humidity (without condensation)	95 %
Vibration resistance	4g per IEC 60068-2-6
Shock resistance	15g per IEC 60068-2-27
EMC immunity to interference	per EN 61000-6-2, marine applications
EMC emission of interference	per EN 61000-6-4, marine applications
Exposure to pollutants	Per IEC 60068-2-42 and IEC 60068-2-43
Permissible H ₂ S contaminant concentration at a relative humidity 75 %	10 ppm
Permissible SO ₂ contaminant concentration at a relative humidity 75 %	25 ppm

Commercial data

Product Group	15 (Remote I/O)
Packaging type	BOX
Country of origin	DE
GTIN	4045454393519
Customs tariff number	85371098990

Approvals / Certificates**Ex-Approvals**

Logo	Approval	Additional Approval Text	Certificate name
	ATEX TUEV Nord Cert GmbH	EN 60079-0	TÜV 07 ATEX 554086 X en.



Subject to changes. Please also observe the further product documentation!

WAGO Kontakttechnik GmbH & Co. KG
 Hansastr. 27
 32423 Minden
 Phone: +49571 887-0 | Fax: +49571 887-169
 Email: info.de@wago.com | Web: www.wago.com

Do you have any questions about our products?
 We are always happy to take your call at 01788 568 008.

Data sheet | Item number: 750-517





www.wago.com/750-517

	TUEV Nord TUEV Nord Cert GmbH	IEC 60079-0	IECEX TUN 09.0001 X
	UL Underwriters Laboratories Inc. (HAZARDOUS LOCATIONS)	UL 121201	E198726 Sec.1

Country specific Approvals

Logo	Approval	Additional Approval Text	Certificate name
	KC National Radio Research Agency	Article 58-2, Clause 3	MSIP- REM-W43- DOM750

Ship Approvals

Logo	Approval	Additional Approval Text	Certificate name
	ABS American Bureau of Shipping	-	19- HG1821926
	BV Bureau Veritas S.A.	-	13453/DO BV
	DNV GL Det Norske Veritas, Germanischer Lloyd	-	TAA0000194
	KR Korean Register of Shipping	-	KR HMB05880- AC001
	LR Lloyds Register	-	02/20026 (E6)
	NK Nippon Kaiji Kyokai	-	TA17255M

Subject to changes. Please also observe the further product documentation!

WAGO Kontakttechnik GmbH & Co. KG
Hansastr. 27
32423 Minden
Phone: +49571 887-0 | Fax: +49571 887-169
Email: info.de@wago.com | Web: www.wago.com

Do you have any questions about our products?
We are always happy to take your call at 01788 568 008.

Data sheet | Item number: 750-517

www.wago.com/750-517

PRS

Polski Rejestr Statków

-

TE/2236

/880590/19



RINA

RINA Germany GmbH

-

ELE066419XG

**UL-Approvals**

Logo	Approval	Additional Approval Text	Certificate name
	UL UL International Netherlands B.V. (ORDINARY LOCATIONS)	UL 508	E175199 Sec.1

Product family**750/753 Series – I/O System**[Show all products from the family](#)

Subject to changes. Please also observe the further product documentation!

WAGO Kontakttechnik GmbH & Co. KG
 Hansastr. 27
 32423 Minden
 Phone: +49571 887-0 | Fax: +49571 887-169
 Email: info.de@wago.com | Web: www.wago.com

Do you have any questions about our products?
 We are always happy to take your call at 01788 568 008.



SCATTERGOOD & JOHNSON LTD

ELECTRICAL ENGINEERING & FLUID CONTROL DISTRIBUTORS

Est.1899

At Scattergood & Johnson Ltd, we pride ourselves on being a technical distributor to specialist industries.

Working with a range of quality product suppliers across a number of specialist markets, we are not your average 'box shifter' - we are your technical and supply chain partner.

We fully support every product we sell - for free! Our internal team and external sales engineers can answer any product or application question, no matter the complexity.

Backing up this technical ability is a range of 50,000+ products available from stock for nationwide next day delivery (same day if required!), or you can collect what you need from any of our trade counters around the UK.

Select your specialist interest below to learn more about how we can help.



Online, In Branch and On the Road - Scattergood & Johnson Ltd, there when you need us.

www.scatts.co.uk