

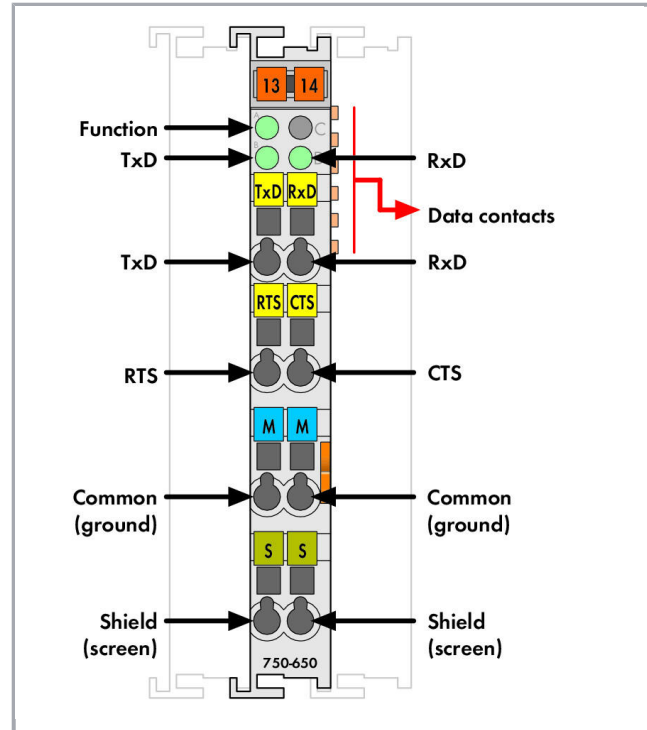

Data sheet | Item number: 750-650/003-000
RS-232 C Serial Interface; Adjustable; light gray

www.wago.com/750-650/003-000



RoHS Compliant

BOMcheck.net

Color:

Subject to changes. Please also observe the further product documentation!

WAGO Kontakttechnik GmbH & Co. KG
 Hansastr. 27
 32423 Minden
 Phone: +49571 887-0 | Fax: +49571 887-169
 Email: info.de@wago.com | Web: www.wago.com

Do you have any questions about our products?
 We are always happy to take your call at 01788 568 008.

Data sheet | Item number: 750-650/003-000

www.wago.com/750-650/003-000

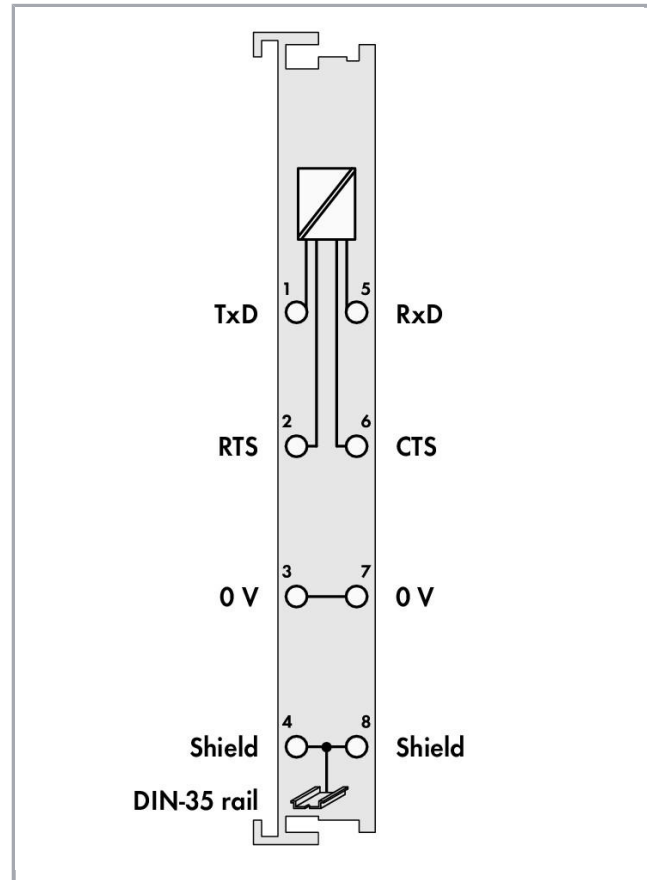
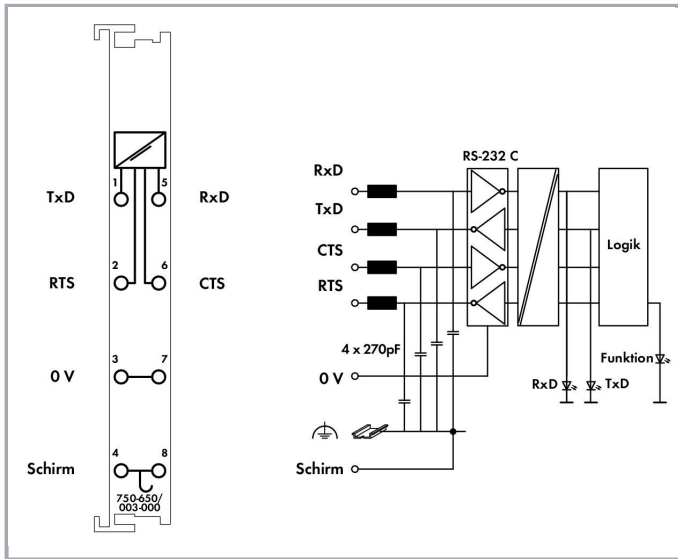

Item description

The I/O module's serial interface connects to RS-232 C interface devices.

The interface operates in accordance with the TIA/EIA-F, CCITT V.28/DIN 66259-1 standard.

The connected device communicates directly with the control unit via the fieldbus coupler. The active communication channel works independently of the higher-level fieldbus system and allows full duplex operation up to 57600 baud.

The RS-232 C interface guarantees high interference immunity via electrically isolated signals.

The shield directly connects to the DIN-rail.

Data

Technical Data

Device-specific	Bit skew: < 3 %; RS-232-C line length (max.): 15 m
Signal type	RS-232
Baud rate	1.2 kBd ... 57.6 kBd (9600 baud (default setting))
Transmission channels	1 TxD / 1 RxD, full-duplex

Subject to changes. Please also observe the further product documentation!

WAGO Kontakttechnik GmbH & Co. KG
 Hansastr. 27
 32423 Minden
 Phone: +49571 887-0 | Fax: +49571 887-169
 Email: info.de@wago.com | Web: www.wago.com

Do you have any questions about our products?
 We are always happy to take your call at 01788 568 008.

Data sheet | Item number: 750-650/003-000www.wago.com/750-650/003-000

Data width	1 x 24-bit input/output (3-byte user data); 1 x 8-bit control/status
Parity	None/Even, adjustable
Number of data bits	7/8, adjustable
Number of stop bits	1/2, adjustable
Buffer	120-byte input / 16-byte output
Supply voltage (system)	DC 5 V; via data contacts
Power consumption (5 V system supply)	55 mA
Isolation	500 V system/field

Connection data

Connection technology: inputs/outputs	8 x CAGE CLAMP®
Connection type (1)	Inputs/Outputs
Solid conductor	0.08 ... 2.5 mm ² / 28 ... 14 AWG
Fine-stranded conductor	0.08 ... 2.5 mm ² / 28 ... 14 AWG
Strip length	8 ... 9 mm / 0.31 ... 0.35 inch

Geometrical Data

Width	12 mm / 0.472 inch
Height	100 mm / 3.937 inch
Depth	69.8 mm / 2.748 inch
Depth from upper edge of DIN-rail	62.6 mm / 2.465 inch

Mechanical data

Mounting type	DIN-35 rail
---------------	-------------

Material Data

Color	light gray
Housing material	Polycarbonate, polyamide 6.6
Fire load	1.191 MJ
Weight	48.1 g
Conformity marking	CE

Environmental Requirements

Surrounding air temperature (operation)	0 ... 55 °C
Surrounding air temperature (storage)	-40 ... 85 °C
Protection type	IP20

Subject to changes. Please also observe the further product documentation!

WAGO Kontakttechnik GmbH & Co. KG
 Hansastr. 27
 32423 Minden
 Phone: +49571 887-0 | Fax: +49571 887-169
 Email: info.de@wago.com | Web: www.wago.com

Do you have any questions about our products?
 We are always happy to take your call at 01788 568 008.

Data sheet | Item number: 750-650/003-000www.wago.com/750-650/003-000

Pollution degree (5)	2 per IEC 61131-2
Operating altitude	0 ... 2000 m
Mounting position	horizontal (standing/lying); vertical
Relative humidity (without condensation)	95 %
Vibration resistance	4g per IEC 60068-2-6
Shock resistance	15g per IEC 60068-2-27
EMC immunity to interference	per EN 61000-6-2, marine applications
EMC emission of interference	per EN 61000-6-4, marine applications
Exposure to pollutants	Per IEC 60068-2-42 and IEC 60068-2-43
Permissible H ₂ S contaminant concentration at a relative humidity 75 %	10 ppm
Permissible SO ₂ contaminant concentration at a relative humidity 75 %	25 ppm

Commercial data

Product Group	15 (Remote I/O)
Packaging type	BOX
Country of origin	DE
GTIN	4045454394271
Customs tariff number	85389099990

Approvals / Certificates**Ex-Approvals**

Logo	Approval	Additional Approval Text	Certificate name
	ATEX TUEV Nord Cert GmbH	EN 60079-0	TÜV 07 ATEX 554086 X en.
	TUEV Nord TUEV Nord Cert GmbH	IEC 60079-0	IECEX TUN 09.0001 X
	UL Underwriters Laboratories Inc. (HAZARDOUS LOCATIONS)	UL 121201	E198726 Sec.1

Country specific Approvals

Subject to changes. Please also observe the further product documentation!

WAGO Kontakttechnik GmbH & Co. KG
Hansastr. 27
32423 Minden
Phone: +49571 887-0 | Fax: +49571 887-169
Email: info.de@wago.com | Web: www.wago.com



Do you have any questions about our products?
We are always happy to take your call at 01788 568 008.

Data sheet | Item number: 750-650/003-000

www.wago.com/750-650/003-000

Logo	Approval	Additional Approval Text	Certificate name
	KC National Radio Research Agency	-	MSIP- REM-W43- SIM750

Ship Approvals

Logo	Approval	Additional Approval Text	Certificate name
	ABS American Bureau of Shipping	-	19- HG1821926
	BV Bureau Veritas S.A.	-	13453/DO BV
	DNV GL Det Norske Veritas, Germanischer Lloyd	-	TAA0000194
	KR Korean Register of Shipping	-	KR HMB05880- AC001
	LR Lloyds Register	-	02/20026 (E6)
	NK Nippon Kaiji Kyokai	-	TA17255M
	PRS Polski Rejestr Statków	-	TE/2236 /880590/19
	RINA RINA Germany GmbH	-	ELE066419XG

Subject to changes. Please also observe the further product documentation!

WAGO Kontakttechnik GmbH & Co. KG
 Hansastr. 27
 32423 Minden
 Phone: +49571 887-0 | Fax: +49571 887-169
 Email: info.de@wago.com | Web: www.wago.com

Do you have any questions about our products?
 We are always happy to take your call at 01788 568 008.

Data sheet | Item number: 750-650/003-000www.wago.com/750-650/003-000**UL-Approvals**

Logo	Approval	Additional Approval Text	Certificate name
	UL UL International Netherlands B.V. (ORDINARY LOCATIONS)	UL 508	E175199 Sec.1

Product family**750/753 Series – I/O System**[Show all products from the family](#)

Subject to changes. Please also observe the further product documentation!

WAGO Kontakttechnik GmbH & Co. KG
 Hansastr. 27
 32423 Minden
 Phone: +49571 887-0 | Fax: +49571 887-169
 Email: info.de@wago.com | Web: www.wago.com

Do you have any questions about our products?
 We are always happy to take your call at 01788 568 008.



SCATTERGOOD & JOHNSON LTD

ELECTRICAL ENGINEERING & FLUID CONTROL DISTRIBUTORS

Est.1899

At Scattergood & Johnson Ltd, we pride ourselves on being a technical distributor to specialist industries.

Working with a range of quality product suppliers across a number of specialist markets, we are not your average 'box shifter' - we are your technical and supply chain partner.

We fully support every product we sell - for free! Our internal team and external sales engineers can answer any product or application question, no matter the complexity.

Backing up this technical ability is a range of 50,000+ products available from stock for nationwide next day delivery (same day if required!), or you can collect what you need from any of our trade counters around the UK.

Select your specialist interest below to learn more about how we can help.



Online, In Branch and On the Road - Scattergood & Johnson Ltd, there when you need us.

www.scatts.co.uk