

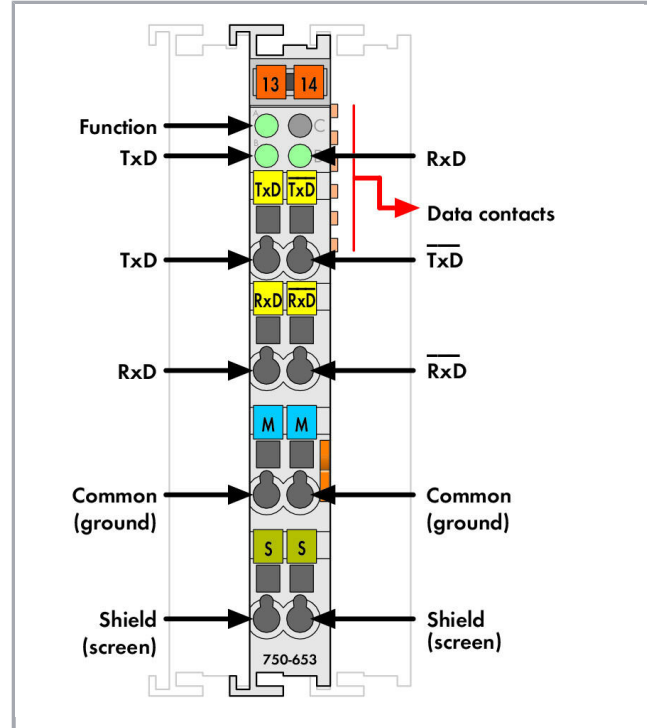

**Data sheet | Item number: 750-653**

RS-485 Serial Interface; 9600 baud; None; 8/1 bits; light gray

[www.wago.com/750-653](http://www.wago.com/750-653)



RoHS  Compliant

[BOMcheck.net](http://BOMcheck.net)

Color:

Subject to changes. Please also observe the further product documentation!

WAGO Kontakttechnik GmbH & Co. KG  
 Hansastr. 27  
 32423 Minden  
 Phone: +49571 887-0 | Fax: +49571 887-169  
 Email: [info.de@wago.com](mailto:info.de@wago.com) | Web: [www.wago.com](http://www.wago.com)

Do you have any questions about our products?  
 We are always happy to take your call at 01788 568 008.

## Data sheet | Item number: 750-653

www.wago.com/750-653

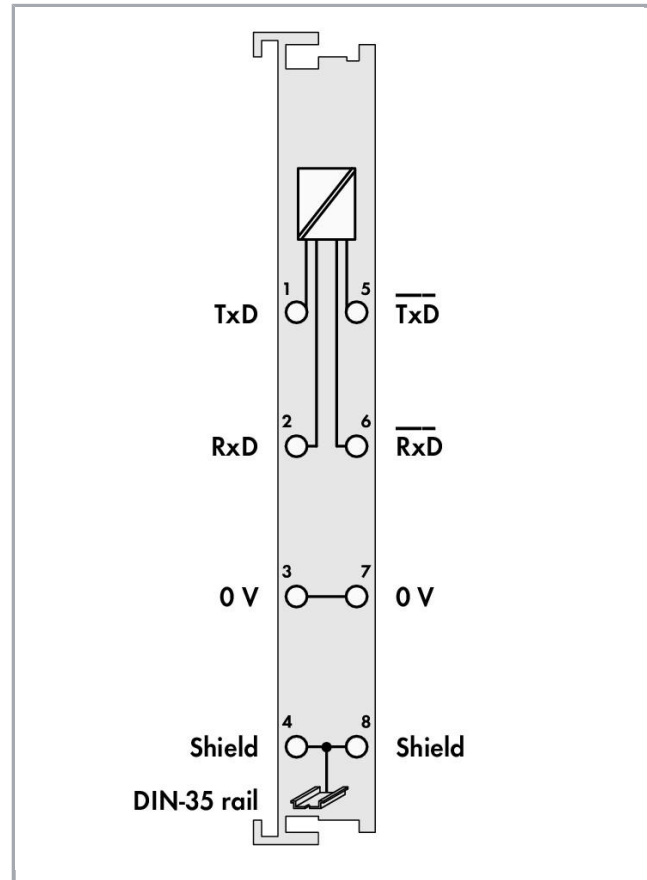
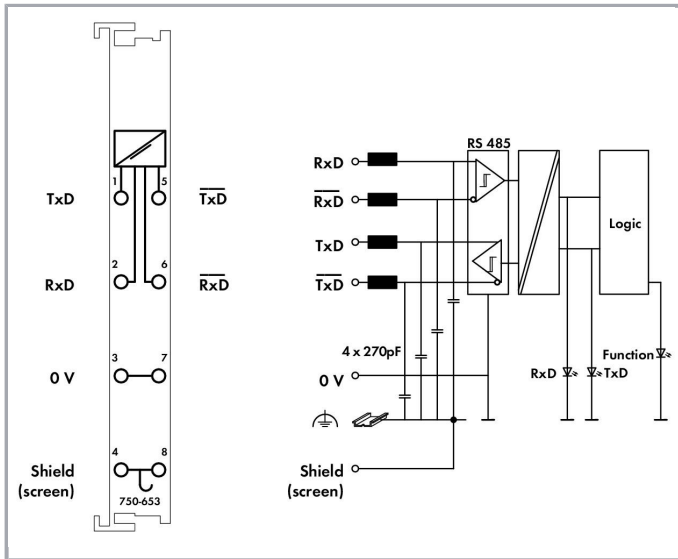

## Item description

The I/O module's serial interface connects to RS-485 interface devices.

The interface operates in accordance with both TIA/EIA-485-A and DIN 66259 standards.

The connected device communicates directly with the control unit via the fieldbus coupler. The active communication channel works independently of the higher-level fieldbus system and allows full duplex operation up to 9600 baud.

The RS-485 interface guarantees high interference immunity via electrically isolated signals.

The shield directly connects to the DIN-rail.

## Data

## Technical Data

Signal type	RS-422 / RS-485
Baud rate	9.6 kBd
Bit transfer	ISO 8482 / DIN 66259 - 4
Transmission channels	1 TxD / 1 RxD, full-duplex

Subject to changes. Please also observe the further product documentation!

WAGO Kontakttechnik GmbH & Co. KG  
 Hansastr. 27  
 32423 Minden  
 Phone: +49571 887-0 | Fax: +49571 887-169  
 Email: info.de@wago.com | Web: www.wago.com

Do you have any questions about our products?  
 We are always happy to take your call at 01788 568 008.

**Data sheet | Item number: 750-653**[www.wago.com/750-653](http://www.wago.com/750-653)

Line length	approx. 1000 m twisted pair
Data width	1 x 24-bit input/output (3-byte user data); 1 x 8-bit control/status
Parity	None
Number of data bits	8
Number of stop bits	1
Buffer	120-byte input / 16-byte output
Supply voltage (system)	DC 5 V; via data contacts
Power consumption (5 V system supply)	65 mA
Isolation	500 V system/field

**Connection data**

Connection technology: inputs/outputs	8 x CAGE CLAMP®
Connection type (1)	Inputs/Outputs
Solid conductor	0.08 ... 2.5 mm <sup>2</sup> / 28 ... 14 AWG
Fine-stranded conductor	0.08 ... 2.5 mm <sup>2</sup> / 28 ... 14 AWG
Strip length	8 ... 9 mm / 0.31 ... 0.35 inch

**Geometrical Data**

Width	12 mm / 0.472 inch
Height	100 mm / 3.937 inch
Depth	69.8 mm / 2.748 inch
Depth from upper edge of DIN-rail	62.6 mm / 2.465 inch

**Mechanical data**

Mounting type	DIN-35 rail
---------------	-------------

**Material Data**

Color	light gray
Housing material	Polycarbonate, polyamide 6.6
Weight	48.8 g
Conformity marking	CE

**Environmental Requirements**

Surrounding air temperature (operation)	0 ... 55 °C
Surrounding air temperature (storage)	-40 ... 85 °C
Protection type	IP20

Subject to changes. Please also observe the further product documentation!

WAGO Kontakttechnik GmbH & Co. KG  
 Hansastr. 27  
 32423 Minden  
 Phone: +49571 887-0 | Fax: +49571 887-169  
 Email: [info.de@wago.com](mailto:info.de@wago.com) | Web: [www.wago.com](http://www.wago.com)

Do you have any questions about our products?  
 We are always happy to take your call at 01788 568 008.

**Data sheet | Item number: 750-653**[www.wago.com/750-653](http://www.wago.com/750-653)

Pollution degree (5)	2 per IEC 61131-2
Operating altitude	0 ... 2000 m
Mounting position	horizontal (standing/lying); vertical
Relative humidity (without condensation)	95 %
Vibration resistance	4g per IEC 60068-2-6
Shock resistance	15g per IEC 60068-2-27
EMC immunity to interference	per EN 61000-6-2, marine applications
EMC emission of interference	per EN 61000-6-4, marine applications
Exposure to pollutants	Per IEC 60068-2-42 and IEC 60068-2-43
Permissible H <sub>2</sub> S contaminant concentration at a relative humidity 75 %	10 ppm
Permissible SO <sub>2</sub> contaminant concentration at a relative humidity 75 %	25 ppm

**Commercial data**

Product Group	15 (Remote I/O)
Packaging type	BOX
Country of origin	DE
GTIN	4045454519582
Customs tariff number	85389099990

**Approvals / Certificates****Ex-Approvals**

Logo	Approval	Additional Approval Text	Certificate name
	ATEX TUEV Nord Cert GmbH	EN 60079-0	TÜV 07 ATEX 554086 X en.
	TUEV Nord TUEV Nord Cert GmbH	IEC 60079-0	IECEX TUN 09.0001 X
	UL Underwriters Laboratories Inc. (HAZARDOUS LOCATIONS)	UL 121201	E198726 Sec.1

**Country specific Approvals**

Subject to changes. Please also observe the further product documentation!

WAGO Kontakttechnik GmbH & Co. KG  
Hansastr. 27  
32423 Minden  
Phone: +49571 887-0 | Fax: +49571 887-169  
Email: [info.de@wago.com](mailto:info.de@wago.com) | Web: [www.wago.com](http://www.wago.com)



Do you have any questions about our products?  
We are always happy to take your call at 01788 568 008.

## Data sheet | Item number: 750-653

[www.wago.com/750-653](http://www.wago.com/750-653)

Logo	Approval	Additional Approval Text	Certificate name
	<b>KC</b> National Radio Research Agency	-	MSIP- REM-W43- SIM750

## Ship Approvals

Logo	Approval	Additional Approval Text	Certificate name
	<b>ABS</b> American Bureau of Shipping	-	19- HG1821926
	<b>BV</b> Bureau Veritas S.A.	-	13453/DO BV
	<b>DNV GL</b> Det Norske Veritas, Germanischer Lloyd	-	TAA0000194
	<b>KR</b> Korean Register of Shipping	-	KR HMB05880- AC001
	<b>LR</b> Lloyds Register	-	02/20026 (E6)
	<b>NK</b> Nippon Kaiji Kyokai	-	TA17255M
	<b>PRS</b> Polski Rejestr Statków	-	TE/2236 /880590/19
	<b>RINA</b> RINA Germany GmbH	-	ELE066419XG

Subject to changes. Please also observe the further product documentation!

WAGO Kontakttechnik GmbH & Co. KG  
 Hansastr. 27  
 32423 Minden  
 Phone: +49571 887-0 | Fax: +49571 887-169  
 Email: [info.de@wago.com](mailto:info.de@wago.com) | Web: [www.wago.com](http://www.wago.com)

Do you have any questions about our products?  
 We are always happy to take your call at 01788 568 008.

**Data sheet | Item number: 750-653**[www.wago.com/750-653](http://www.wago.com/750-653)**UL-Approvals**

Logo	Approval	Additional Approval Text	Certificate name
	<b>UL</b> UL International Netherlands B.V. (ORDINARY LOCATIONS)	UL 508	E175199 Sec.1

**Product family****750/753 Series – I/O System**[Show all products from the family](#)

Subject to changes. Please also observe the further product documentation!

WAGO Kontakttechnik GmbH & Co. KG  
 Hansastr. 27  
 32423 Minden  
 Phone: +49571 887-0 | Fax: +49571 887-169  
 Email: [info.de@wago.com](mailto:info.de@wago.com) | Web: [www.wago.com](http://www.wago.com)

Do you have any questions about our products?  
 We are always happy to take your call at 01788 568 008.



# SCATTERGOOD & JOHNSON LTD

ELECTRICAL ENGINEERING & FLUID CONTROL DISTRIBUTORS

Est.1899

At Scattergood & Johnson Ltd, we pride ourselves on being a technical distributor to specialist industries.

Working with a range of quality product suppliers across a number of specialist markets, we are not your average 'box shifter' - we are your technical and supply chain partner.

We fully support every product we sell - for free! Our internal team and external sales engineers can answer any product or application question, no matter the complexity.

Backing up this technical ability is a range of 50,000+ products available from stock for nationwide next day delivery (same day if required!), or you can collect what you need from any of our trade counters around the UK.

Select your specialist interest below to learn more about how we can help.



Online, In Branch and On the Road - Scattergood & Johnson Ltd, there when you need us.

# [www.scatts.co.uk](http://www.scatts.co.uk)