

6013



Plunger valve 2/2 way direct-acting



Type 6013 can be combined with...



Type 1078



Type 2508

- Direct-acting and compact valve up to diameter of DN 6.0
- Vibration-proof, bolted coil system
- Increased leak-tightness with welded plunger guide tube
- Explosion proof versions
- Energy-saving pulse versions

Valve 6013 is a direct-acting plunger valve. The stopper and plunger guide tube are welded together to enhance pressure resistance and leak-tightness. Various seal material combinations are available depending on the application. A Bürkert-specific flange design (SFB) enables space-saving arrangement of valves on a manifold. The coils are moulded with polyamide or with chemically resistant epoxy. Pulse coils and 'Kick and Drop' electronics are available for overexcitation (plug 2511) for the reduction of electrical power consumption during operation. Optional manual actuation enables quick commissioning and easy maintenance. In combination with a plug in accordance with DIN EN 17301-803 Form A, the valves satisfy protection class IP65. Stainless steel valves satisfy NEMA 4X.

Technical data		
Body material	Type 6013 Type 6013 A	Brass, stainless steel 1.4305 Brass, stainless steel 1.4305
Seal material		FKM, PTFE/Graphite (EPDM on request)
Analysis version	Type 6013 A	Silicon, oil and fat free version Tightness < 10 ⁻⁴ mbar l/s
Limit value for residual carbon	Type 6013 A	< 0.2 mg/dm ²
Medium	Type 6013 Type 6013 A	<ul style="list-style-type: none"> • Technical vacuum • Neutral gases and liquids (e.g. compressed air, water, hydraulic oil) • Neutral medium, which does not attack the body and seal materials (see chemical resistance chart)
Medium temperature	FKM PTFE/Graphite FKM, Circuit function B	- 10 to + 100 °C (PA coil) till 120 °C (Epoxy coil) - 40 to + 180 °C (see chemical resistance chart) - 10 to 100 °C (AC) - 10 to 120 °C (DC)
Ambient temperature		Max. + 55 °C
Viscosity		Max. 21 mm ² /s
Port connection	Type 6013 Type 6013 A	G 1/8, G 1/4, G 3/8, sub-base (SFB) G 1/8, G 1/4
Operating voltage	Type 6013 Type 6013 A	24 V DC, 24 V/50 Hz, 230 V/50 Hz 24 V DC, 230 V/50 Hz (other voltages on request)
Voltage tolerance		± 10 %
Duty cycle/single valve		100 % continuous rating Intermittent operation 60 % (30 min) or with 5 W coil on request
Electrical connection		Tag connector acc. to DIN EN 175301-803 Form A (previously DIN 43650) for cable plug Type 2508 (see accessories) ATEX/IECEx version with 3 m moulded cable
Installation		As required, preferably with actuator upright
Assembly		No oils, fats or silicone to be used during installation
Protection class		IP65 with cable plug, ATEX/IECEx junction box version and cable connection version
Coil insulation class		Polyamide class B Epoxy class H

Circuit Function A

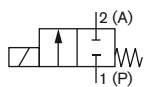

2/2 way direct-acting solenoid valve, normally closed

Circuit Function B

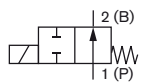

2/2 way direct-acting solenoid valve, normally open

DTS 1000011032 EN Version: AC Status: RL (released | freigegeben | valide) printed: 10.02.2020

Technical data, (continued)

Circuit function A

Orifice [mm]	Port connection	K _v value water [m ³ /h]	Weight [g]	Power consumption ¹⁾ [W]	Electr. power		Coil size	Response times	
					Inrush (AC)	Hold (AC)		opening [ms]	closed [ms]
2.0	G 1/8	0.12	325	8 W AC or 8 W DC (9)	24 VA	17 VA	5 (32 mm)	20	30
2.0	G 1/4	0.12	465	8 W AC or 8 W DC (9)	24 VA	17 VA	5 (32 mm)	20	30
2.0	sub-base	0.12	290	8 W AC or 8 W DC (9)	24 VA	17 VA	5 (32 mm)	20	30
2.5	G 1/8	0.16	325	8 W AC or 8 W DC (9)	24 VA	17 VA	5 (32 mm)	20	30
2.5	G 1/4	0.16	465	8 W AC or 8 W DC (9)	24 VA	17 VA	5 (32 mm)	20	30
3.0	G 1/8	0.23	325	8 W AC or 8 W DC (9)	24 VA	17 VA	5 (32 mm)	20	30
3.0	G 1/4	0.23	465	8 W AC or 8 W DC (9)	24 VA	17 VA	5 (32 mm)	20	30
3.0	G 3/8	0.23	550	10 W AC or 10 W DC (11)	30 VA	22 VA	6 (40 mm)	20	30
4.0	G 1/4	0.30	465	8 W AC or 8 W DC (9)	24 VA	17 VA	5 (32 mm)	20	30
4.0	G 3/8	0.30	550	10 W AC or 10 W DC (11)	30 VA	22 VA	6 (40 mm)	20	30
6.0	G 1/4	0.55	465	8 W AC or 8 W DC (9)	24 VA	17 VA	5 (32 mm)	20	30
6.0	G 3/8	0.55	550	10 W AC or 10 W DC (11)	30 VA	22 VA	6 (40 mm)	20	30

Circuit function B

Orifice [mm]	Port connection	K _v value water [m ³ /h]	Weight [g]	Power consumption ¹⁾ [W]	Electr. power		Coil size	Response times	
					Inrush (AC)	Hold (AC)		opening [ms]	closed [ms]
2.00	G 1/8	0.12	325	7 W(AC) or 8 W DC (9)	24 VA	17 VA	5 (32 mm)	20	30
2.00	G 1/4	0.12	465	7 W(AC) or 8 W DC (9)	24 VA	17 VA	5 (32 mm)	20	30
2.00	sub-base	0.12	290	7 W(AC) or 8 W DC (9)	24 VA	17 VA	5 (32 mm)	20	30
3.00	G 1/8	0.23	325	7 W(AC) or 8 W DC (9)	24 VA	17 VA	5 (32 mm)	20	30
3.00	G 1/4	0.23	465	7 W(AC) or 8 W DC (9)	24 VA	17 VA	5 (32 mm)	20	30
3.00	sub-base	0.23	290	7 W(AC) or 8 W DC (9)	24 VA	17 VA	5 (32 mm)	20	30
4.00	G 1/4	0.3	465	7 W(AC) or 8 W DC (9)	24 VA	17 VA	5 (32 mm)	20	30
6.00	G 1/4	0.55	465	7 W(AC) or 8 W DC (9)	24 VA	17 VA	5 (32 mm)	20	30

¹⁾ Values in brackets at coil temperature 20 °C

Materials

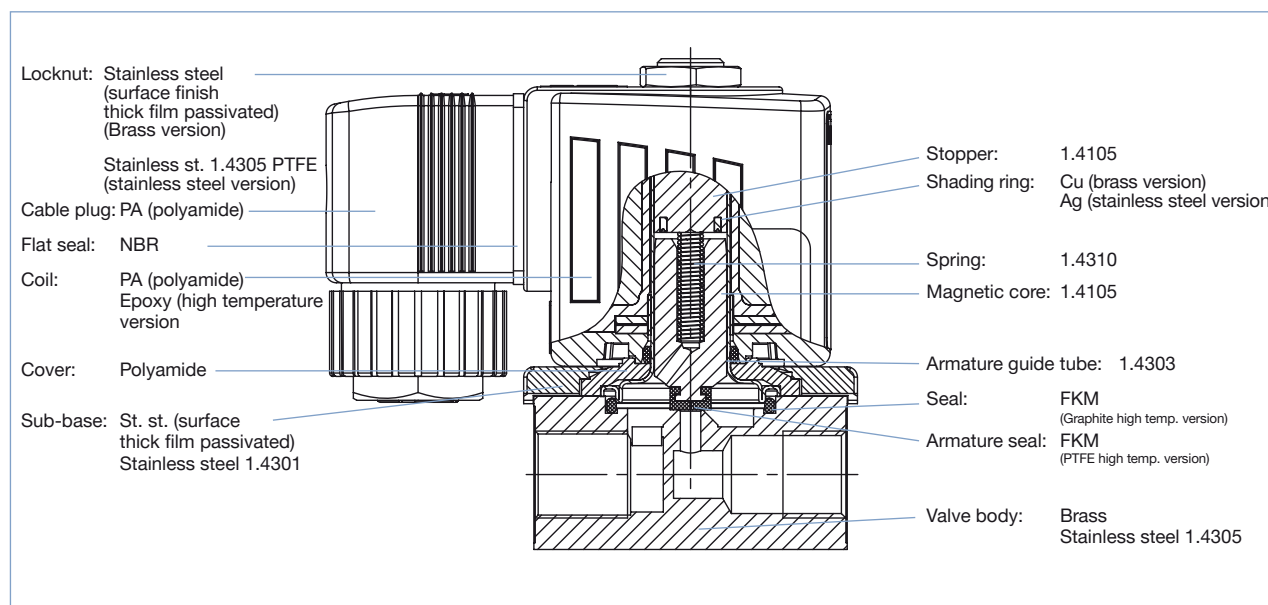

DTS 1000011032 EN Version: AC Status: RL (released | freigegeben | valide) printed: 10.02.2020

Dimensions [mm]

View without cable plug

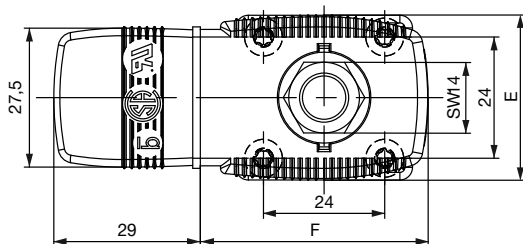
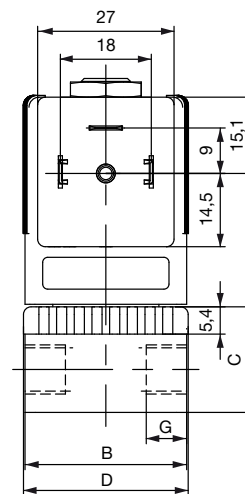
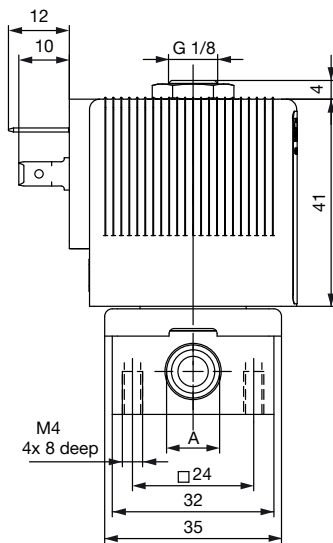

Sub-base version (SFB)
underside view

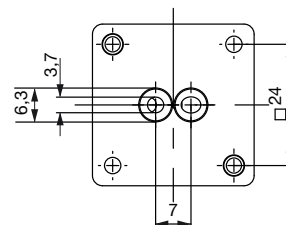

G 3/8 connection

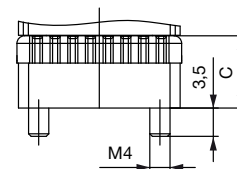
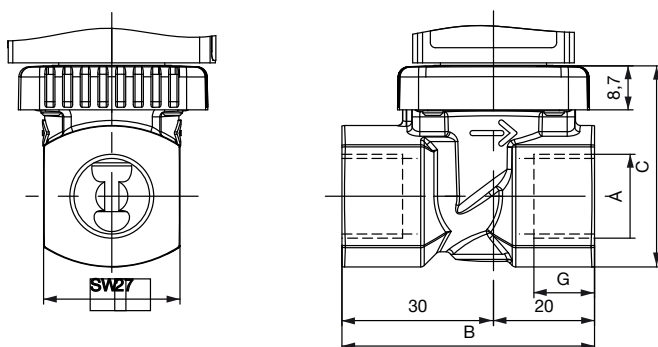

Port connection	Body dimensions [mm]				
	A	B	C	D	G
G 1/8	G 1/8	32	20.8	32.6	8
G 1/4	G 1/4	46	26.8	49	12
G 3/8	G 3/8	50	39.8	49	12
Sub-base (SFB)	-	32	14.3	32.6	-

Coil width E [mm]	Coil depth F [mm]
32 (8 W)	45 (8 W)
32 (8 W)	45 (8 W)
40 (10 W)	51 (10 W)
32 (8 W)	45 (8 W)











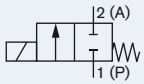









































6013

bürkert

Ordering chart for valves (other versions on request)

6013 Normally closed valve with FKM seal, brass or stainless steel body (class B)

Delivered without cable plug (see accessories)

Circuit function	Orifice [mm]	Port connection	K _v value water [m ³ /h] ¹⁾	Coil power [W]	Pressure range [bar] ²⁾	Voltage/Frequency [V/Hz]	Article no. brass body FKM Seal	Article no. Stainless steel body, FKM seal
A 2/2 way valve NC 	2.0	G 1/8	0.12	8	0 - 12	024/DC	134237 	134233 
					0 - 25	024/50	132865 	134234 
					0 - 25	230/50	134239 	134236 
		G 1/4	0.12	8	0 - 12	024/DC	137537 	137533 
					0 - 25	024/50	137538 	137534 
					0 - 25	230/50	137540 	137536 
		sub-base (SFB)	0.12	8	0 - 12	024/DC	134244 	-
					0 - 25	024/50	134245 	-
					0 - 25	230/50	134247 	-
	2.5	G 1/8	0.16	8	0 - 10	024/DC	134240 	-
					0 - 16	024/50	134241 	-
					0 - 16	230/50	134243 	-
	3.0	G 1/8	0.23	8	0 - 6	024/DC	126091 	126078 
					0 - 10	024/50	126092 	126079 
					0 - 10	230/50	126094 	126081 
		G 1/4	0.23	8	0 - 6	024/DC	125301 	125317 
					0 - 10	024/50	125302 	126082 
					0 - 10	230/50	125304 	126084 
		G 3/8	0.23	10	0 - 8	024/DC	134248 	-
					0 - 14	024/50	134249 	-
					0 - 14	230/50	134251 	-
	4.0	G 1/4	0.30	8	0 - 1.5	024/DC	125306 	125318 
					0 - 4	024/50	125307 	125319 
					0 - 4	230/50	125309 	125320 
G 3/8		0.30	10	0 - 2.5	024/DC	134252 	-	
				0 - 6	024/50	134253 	-	
				0 - 6	230/50	134255 	-	
6.0	G 1/4	0.55	8	0 - 0.5	024/DC	125311 	126086 	
				0 - 1.5	024/50	125312 	126087 	
				0 - 1.5	230/50	125314 	126089 	
	G 3/8	0.55	10	0 - 0.75	024/DC	134256 	-	
				0 - 2.5	024/50	134257 	-	
				0 - 2.5	230/50	134259 	-	

¹⁾ Measured at +20 °C, 1 bar²⁾ pressure at valve inlet and free outlet..²⁾ Measured as overpressure to the atmospheric pressure









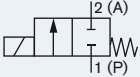

6013

bürkert

Ordering chart for valves (continued)

6013 Normally closed valve for high temp. applications (- 40 °C to + 180 °C) PTFE seat seal, brass body (class H)









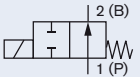

Delivered without cable plug (see accessories)

Circuit function	Orifice [mm]	Port connection	K _v value water [m ³ /h] ¹⁾	Coil power [W]	Pressure range [bar] ²⁾	Voltage/Frequency [V/Hz]	Article no.			
A 2/2 way valve NC 	2.0	G ¼	0.12	8	0 - 12	024/DC	136015 			
					0 - 25	024/50	136016 			
					0 - 25	230/50	136018 			
	3.0	G ¼	0.23	10	0 - 6	024/DC	136019 			
					0 - 10	024/50	136020 			
					0 - 10	230/50	136022 			
					G ⅜	0.23	10	0 - 8	024/DC	136023 
								0 - 14	024/50	136024 
								0 - 14	230/50	136026 

¹⁾ Measured at +20 °C, 1 bar²⁾ pressure at valve inlet and free outlet.²⁾ Measured as overpressure to the atmospheric pressure.

6013 Normally open valve with FKM seal, brass body (class H)

Delivered without cable plug (see accessories)

Circuit function	Orifice [mm]	Port connection	K _v value water [m ³ /h] ¹⁾	Pressure range [bar] ²⁾	Coil power [W]	Voltage/Frequency [V/Hz]	Article no.
B 2/2 way valve NO 	2.0	G ⅜	0.12	0 - 16	8	24/DC	213543 
					7	230/50	213550 
	3.0	G ⅜	0.23	0 - 8	8	24/DC	213545 
					7	230/50	213551 
					8	24/DC	213546 
					7	230/50	213552 
	4.0	G ¼	0.3	0 - 4	8	024/DC	213548 
					7	230/50	213553 
	6.0	G ¼	0.55	0 - 2	8	024/DC	213549 
					7	230/50	213554 

¹⁾ Measured at +20 °C, 1 bar²⁾ pressure at valve inlet and free outlet..²⁾ Measured as overpressure to the atmospheric pressure

6013

bürkert

Ordering chart - Standard temperature version for DC power supply, impulse version

6013 Impulse valves, seal material FKM (class H)

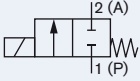
Circuit function	Port connection	Orifice [mm]	K _v value water [m ³ /h] ¹⁾	Pressure range [bar] ²⁾	Power consumption DC (hot/cold coil) [W]	Article no. per voltage [V]	
						012/DC	024/DC
A 2/2 way valve 	Brass body						
	Sub-base (SFB)	2.0	0.12	0 - 16	7	209266	209272
		2.5	0.16	0 - 10	7	209267	209273
		3.0	0.23	0 - 6	7	209268	209274
	G 1/8	2.0	0.12	0 - 16	7	209269	209275
		2.5	0.16	0 - 10	7	209270	209276
3.0		0.23	0 - 6	7	209271	209277	

¹⁾ Measured at +20 °C, 1 bar²⁾ pressure at valve inlet and free outlet²⁾ Measured as overpressure to the atmospheric pressure

Please note that the cable plug must be ordered separately (see accessories and separate datasheet, Type 2508).

Control for impulse version with polarity reversal control

Polarity is marked on the coil with a label	Features	Terminal connections
- switch ON +	valve open	(+) on terminal 2 and (-) on terminal 1 (see below)
+ switch OFF -	valve closed	(+) on terminal 1 and (-) on terminal 2 (see below)

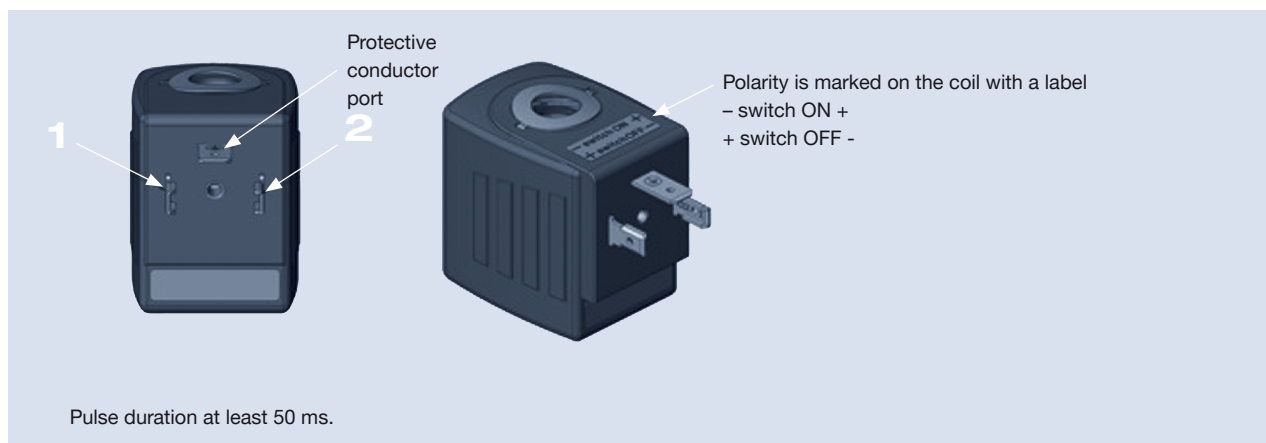

Note: Please use only the cable plug without electrical circuitry for the impulse version

6013

bürkert

Technical data - analytical version

Analysis version	Media flowing through are not contaminated
Limit for residual carbon	<0.2 mg/dm ²
Permissible leakage rate for medium	10 ⁻⁴ mbar l/sec <ul style="list-style-type: none"> • Neutral medium, which does not attack the body and seal materials • Technical vacuum
Electr. connection	Tag connector acc. to DIN EN 175301-803 Form A (previously DIN43650) for cable plug Type 2508 (see accessories)
Mounting instructions	No oils, fats or silicone used during the assembly







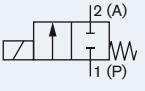

Solenoid valves for higher Requirements
 This version is particularly suitable for switching from extremely pure gaseous medium. All media-affected parts are submitted to additional purification processes, so that the media is not contaminated under any circumstances.

The tightness test takes place at the Helium leak detector from a min. of 10⁻⁴ mbar l/sec.

Ordering chart (other versions on request)

6013 Analysis normally closed valve with seal material FKM and brass body (class B)

Delivered without cable plug (see accessories)







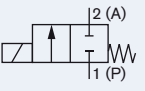

Circuit function	Orifice [mm]	Port connection	K _v value water [m ³ /h] ¹⁾	Pressure range [bar] ²⁾	Coil power [W]	Voltage/Frequency [V/Hz]	Article no.
A 2/2 way valve NC 	2.0	G 1/8	0.12	0 - 12	8	24/DC	137826 
				0 - 25		230/50	137827 
	2.5	G 1/8	0.16	0 - 10	8	24/DC	137828 
				0 - 16		230/50	137829 
	3.0	G 1/4	0.23	0 - 6	8	24/DC	137830 
				0 - 10		230/50	137831 
	4.0	G 1/4	0.30	0 - 1.5	8	24/DC	137832 
				0 - 4		230/50	137833 

¹⁾ Measured at +20 °C, 1 bar²⁾ pressure at valve inlet and free outlet..

²⁾ Measured as overpressure to the atmospheric pressure

6013 Analysis normally closed valve with seal material FKM and stainless steel body (class B)

Delivered without cable plug (see accessories)

Circuit function	Orifice [mm]	Port connection	K _v value water [m ³ /h] ¹⁾	Pressure range [bar] ²⁾	Coil power [W]	Voltage/Frequency [V/Hz]	Article no.
A 2/2 way valve NC 	2.0	G 1/8	0.12	0 - 12	8	24/DC	137818 
				0 - 25		230/50	137819 
	2.0	G 1/4	0.12	0 - 12	8	24/DC	137820 
				0 - 25		230/50	137821 
	3.0	G 1/4	0.23	0 - 6	8	24/DC	137822 
				0 - 10		230/50	137823 
	4.0	G 1/4	0.30	0 - 1.5	8	24/DC	137824 
				0 - 4		230/50	137825 

¹⁾ Measured at +20 °C, 1 bar²⁾ pressure at valve inlet and free outlet..

²⁾ Measured as overpressure to the atmospheric pressure

Please note that the cable plug must be ordered separately (see accessories and separate datasheet, Type 2508).

6013

bürkert

Technical data of the DVGW version







DVGW version	DIN EN 161:2013; DIN EN 13611:2015
Seal material	NBR
Medium	Flammable gases such as town gas; district gas; liquid gas; hydrogen
Mediums temperature	0 to +80 °C
Ambient temperature	0 to +55 °C
Max. Operating pressure	0 to 5 bar
Circuit function	A normally closed

The Type 6013 DVGW solenoid valve is designed primarily as an automatic safety shut-off valve for flammable gases. A strainer is installed in the inlet of the valve.

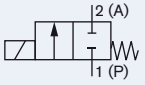
Ordering chart for valves (other versions on request)

6013 Normally closed valve with NBR seal, brass body (class B)

Delivered without cable plug (see accessories)

Circuit function	Orifice [mm]	Port connection	K _v -value [m ³ /h] ¹⁾	Pressure range [bar] ²⁾	Coil power [Watt]	Voltage/frequency [V/Hz]	Article no.
A 2/2 way valve NC 	3	G 1/4	0.23	0-5	8	24/DC	258362 
	3	G 1/4	0.23	0-5	8	230/50	296548 
	4	G 1/4	0.3	0-1.5	8	24/DC	258361 
	4	G 1/4	0.3	0-4	8	230/50	296549 
	6	G 1/4	0.55	0-0.5	8	24/DC	266293 
	6	G 1/4	0.55	0-1.5	8	230/50	301072 

¹⁾ Measured at + 20 °C, 1 bar²⁾ pressure at valve inlet and free outlet

²⁾ Measured as overpressure to the atmospheric pressure

6013

bürkert

Materials for ATEX/IECEx cable version

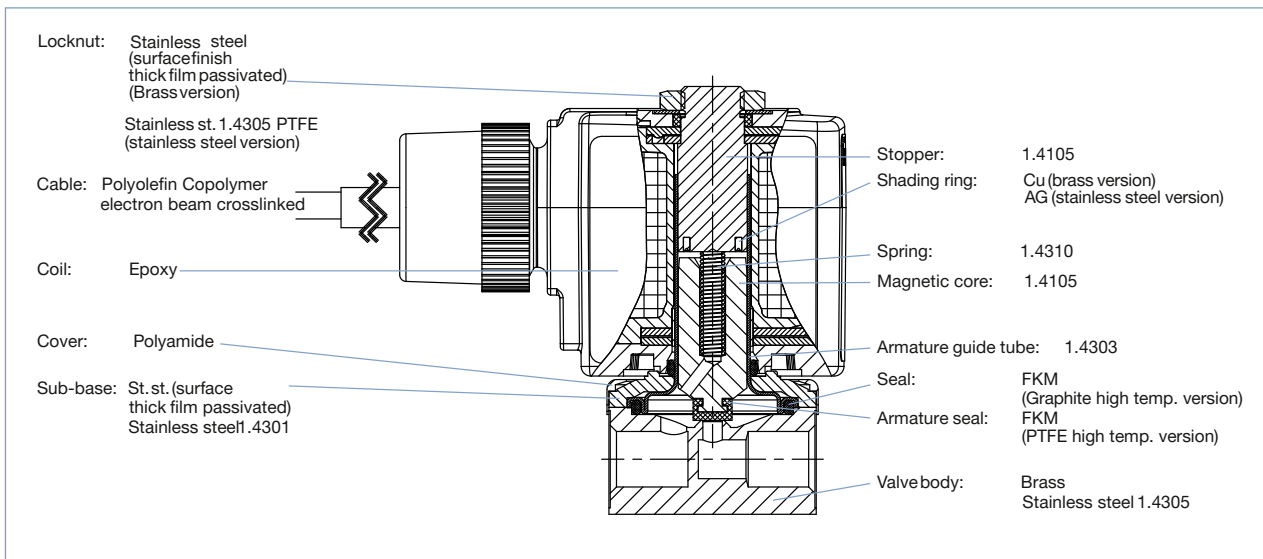

DTS 1000011032 EN Version: AC Status: RL (released | freigegeben | validé) printed: 10.02.2020

6013

bürkert

Dimensions for ATEX/IECEx cable version [mm]

Threaded version, G1/8

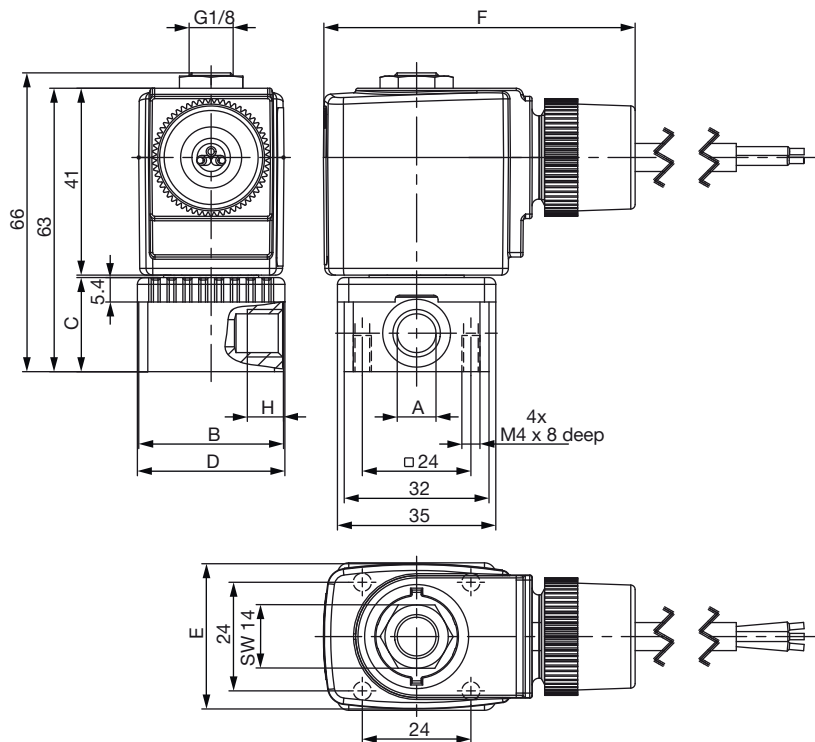

Threaded version, G3/8

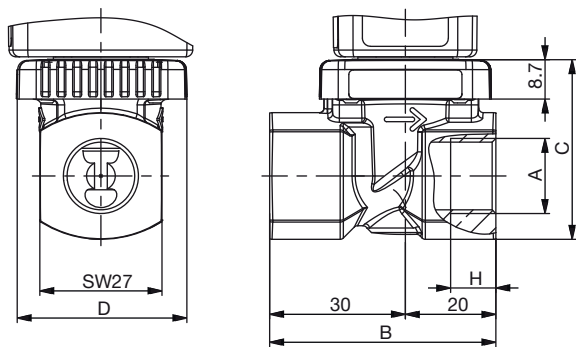

Sub-base version (SFB) underside view

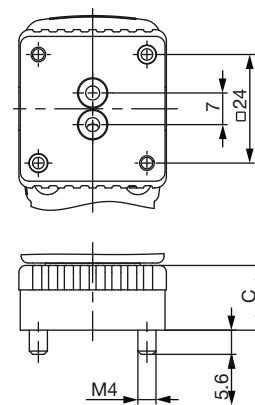

Port connection	Body dimensions [mm]				
	A	B	C	D	H
G 1/8	G 1/8	32	20.8	32.6	8
G 1/4	G 1/4	46	26.8	49	12
G 3/8	G 3/8	50	39.8	38	12
Sub-base version (SFB)	-	32	13.3	32.6	-

Coil size	E [mm]	F [mm]
5	32	69
6	40	75

DTS 1000011032 EN Version: AC Status: RL (released | freigegeben | valide) printed: 10.02.2020

6013

bürkert

Ordering chart for valves - ATEX/IECEx cable versions (other versions on request)

6013 Normally closed valve, Ex m T4 approved with seal material FKM and molded cable (3 m), single mounting only

Circuit function	Orifice [mm]	Port connection	K _v value water [m ³ /h]	Coil effective power [W]	Pressure range [bar]	Voltage/Frequency [V/Hz]	Article no.	
							Brass body	Stainless steel body
	2.0	sub-base (SFB)	0.11	7	0-6	24/UC	278607	278614
		G 1/8	0.12	9	0-10	24/UC	278608	x
						230/UC	278592	278584
		G 1/4	0.12	9	0-10	24/UC	x	278585
						230/UC	278605	278601
		2.5	G 1/8	0.16	9	0-8	24/UC	278606
	230/UC						278593	x
	3.0	G 1/8	0.23	9	0-5	24/UC	x	x
						230/UC	278586	278587
		G 1/4	0.23	9	0-5	24/UC	278594	278587
						230/UC	278596	278589
	4.0	G 1/4	0.30	9	0-1.2	24/UC	278597	278590
						230/UC	278597	x
	6.0	G 1/4	0.55	9	0-0.4	24/UC	278598	278604
230/UC						278599	x	

x on request

The maximum fluid temperature must not in any case exceed the permissible temperature class (T4 135 °C, 100 °C T5, T6 85 °C), minus 5 K).

ATEX and IECEx approval for coils with fixed cable outlet

ATEX: PTB 14 ATEX 2023 X

IECEx: IECEx PTB 14.0049 X

II 2G Ex mb IIC T4 Gb

Ex mb IIC T4 Gb

II 2D Ex mb IIIC T135 °C Db

Ex mb IIIC T135 °C Db

6013

bürkert

Materials for ATEX/IECEx junction box version

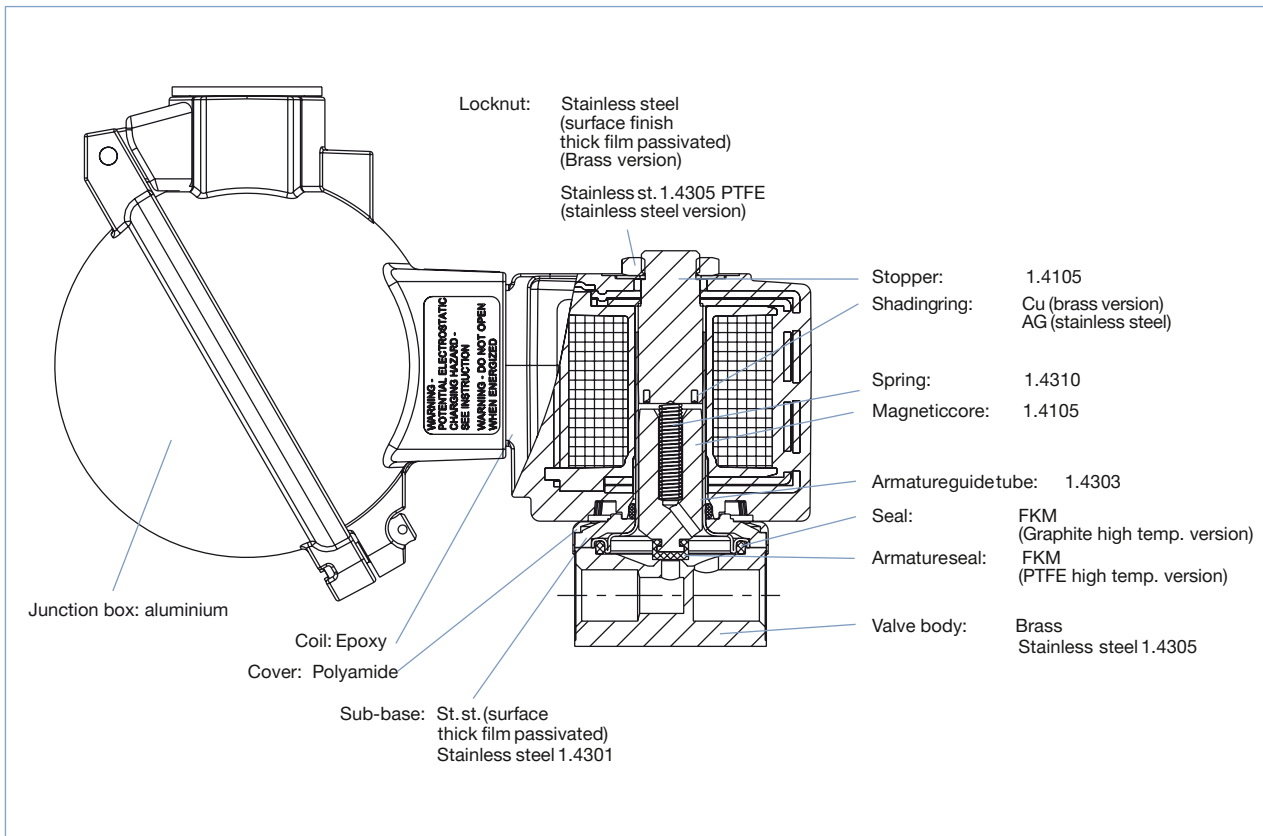

DTS 1000011032 EN Version: AC Status: RL (released | freigegeben | valide) printed: 10.02.2020

6013

bürkert

Dimensions for ATEX/IECEX junction box version

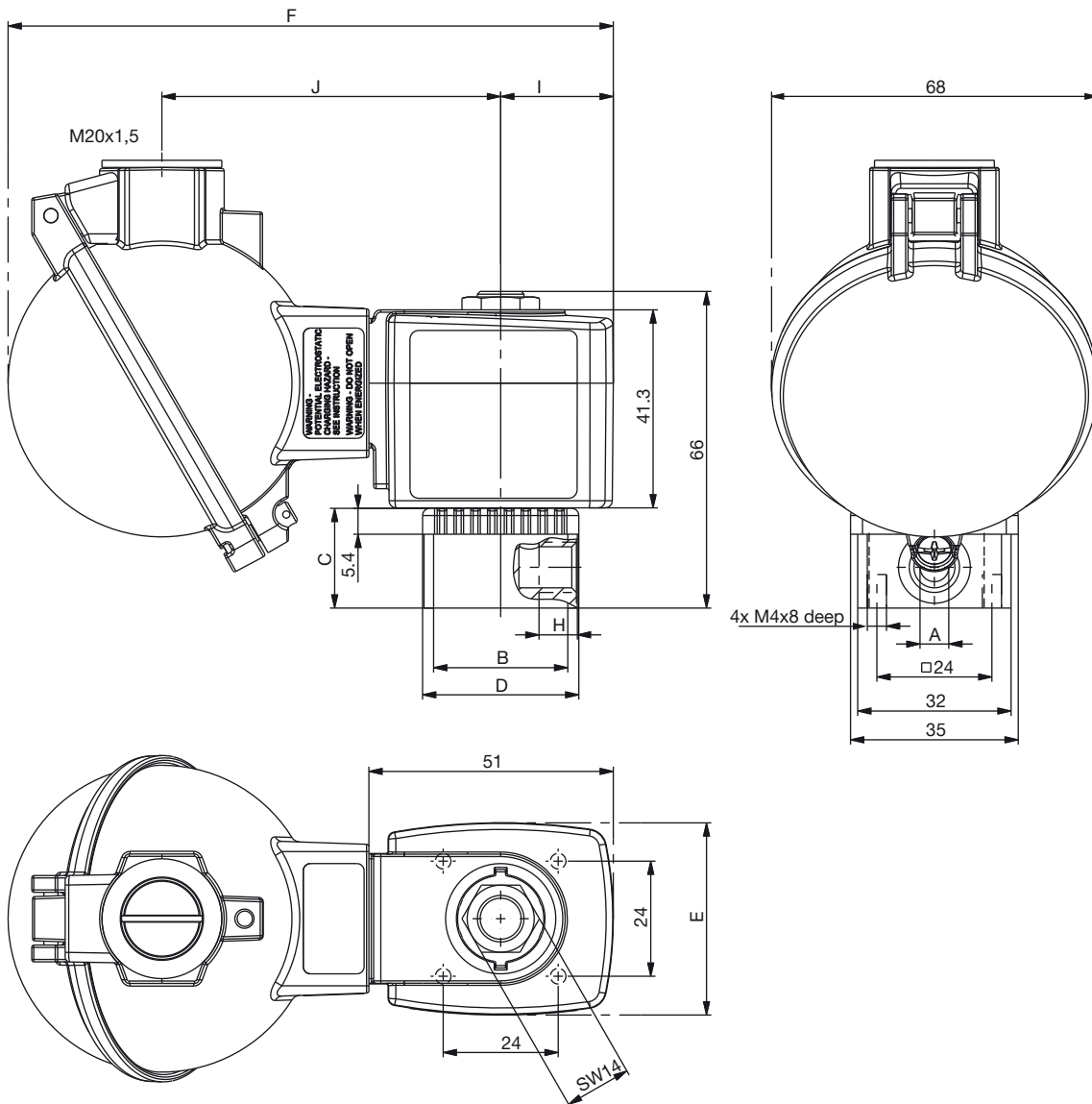

Port connection	Body dimensions [mm]				
	A	B	C	D	H
G 1/8	G 1/8	32	20.8	32.6	8
G 1/4	G 1/4	46	26.8	49	12
G 3/8	G 3/8	50	39.8	38	12
Sub-base version (SFB)	-	32	13.3	32.6	-

Coil size	E [mm]	F	I	J
5	32	120.3	20.5	69
6	40	126.3	23.5	70.7

DTS 1000011032 EN Version: AC Status: RL (released | freigegeben | valide) printed: 10.02.2020

Ordering chart for valves - ATEX/IECEX junction box versions (other versions on request)

6013 Normally closed valve, Ex m T4 approved with seal material FKM and junction box, single mounting only

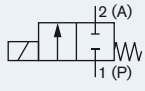
Circuit function	Orifice [mm]	Port connection	K _v value	Coil effective power	Pressure range	Voltage/Frequency	Article no. Brass body	Article no. Stainless steel body	
A 2/2 way valve NC 	1.5	sub-base (SFB)	0.08	9	0-16	24/UC	288424	x	
	2	G 1/8	0.12			0-10	24/UC	288430	288437
							230/UC	288431	288438
					24/UC		288433	288439	
	3	G 1/4	0.23		0-5	24/UC	288435	288441	
						230/UC	x	x	
						24/UC	x	288449	
	4	G 1/4	0.3		0-1.2	230/UC	x	288451	
						24/UC	288452	288453	
	6	G 1/4	0.55		0-0.4	230/UC	x	288455	
						24/UC	288456	288459	
							230/UC	288457	288460

x on request

The maximum fluid temperature must not in any case exceed the permissible temperature class (T4 135 °C, 100 °C T5, T6 85 °C), minus 5 K.



ATEX and IECEX approval for the assembly of the coil and the junction box

ATEX: EPS 16 ATEX 1046 X
 II 2G Ex eb mb IIC T4 Gb
 II 2D Ex mb tb IIIC T130 °C Db

IECEX: IECEX EPS 16.0021 X
 Ex eb mb IIC T4 Gb
 Ex mb tb IIIC T130 °C Db

Ex-Cable glands

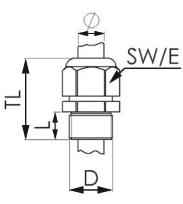
(polyamide version included in delivery / surcharge applied for brass nickel plated version)

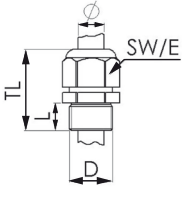
Photo	Description	Ex Approvals		Article no	Drawing										
		Certification	Identification												
	Brass, nickelplated, 6 - 13 mm	PTB 04 ATEX 1112 X, IECEX PTB 13.0027X	II 2 G Ex e IIC Gb, II 2 D Ex tb IIIC Db IP68,	773278	 <table border="1"> <tr><td>TL</td><td>29 - 37 mm</td></tr> <tr><td>L</td><td>6 mm</td></tr> <tr><td>D</td><td>20</td></tr> <tr><td>SW</td><td>24 mm</td></tr> <tr><td>E</td><td>27 mm</td></tr> </table>	TL	29 - 37 mm	L	6 mm	D	20	SW	24 mm	E	27 mm
TL	29 - 37 mm														
L	6 mm														
D	20														
SW	24 mm														
E	27 mm														
	Polyamide, 7 - 13 mm	PTB 13 ATEX 1015 X, IECEX PTB 13.0034X	II 2 G Ex e IIC Gb, II 2 D Ex tb IIIC Db IP68	773277	 <table border="1"> <tr><td>TL</td><td>36 - 45 mm</td></tr> <tr><td>L</td><td>10 mm</td></tr> <tr><td>D</td><td>20</td></tr> <tr><td>SW</td><td>24 mm</td></tr> <tr><td>E</td><td>28 mm</td></tr> </table>	TL	36 - 45 mm	L	10 mm	D	20	SW	24 mm	E	28 mm
TL	36 - 45 mm														
L	10 mm														
D	20														
SW	24 mm														
E	28 mm														

Special tool to turn the junction box (not included in delivery)

Photo	Description	Article no.
	Set SC02-AC10 Special wrench Service Manual	293488

DTS 1000011032 EN Version: AC Status: RL (released | freigegeben | valide) printed: 10.02.2020

Manifold mounting

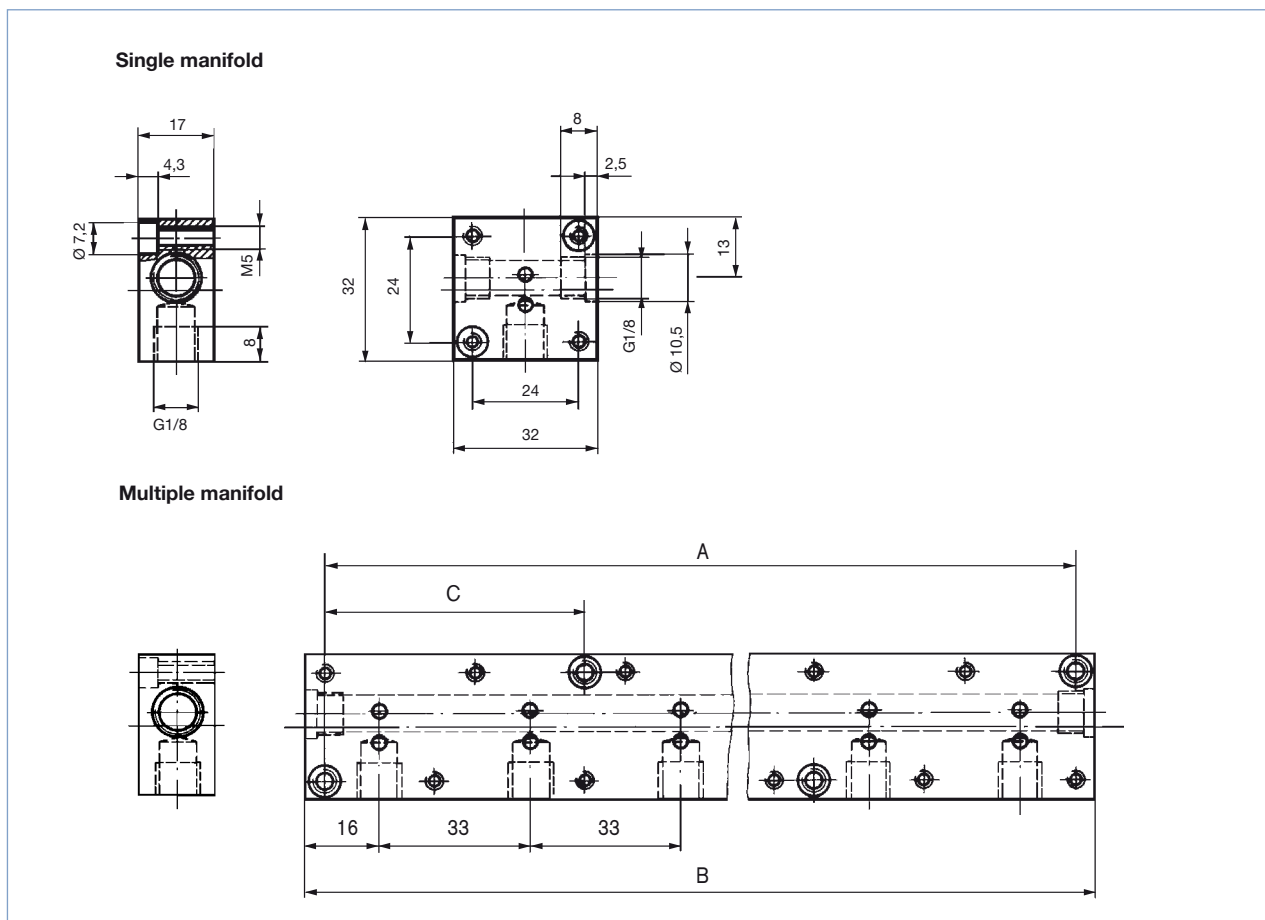

Ordering chart for Manifolds

Accessory part	Quantity of valve places				Article no.
Single manifold	in aluminium				005020
Multiple manifold	in aluminium	Hole spacing A [mm]	Total length B [mm]	Hole spacing C [mm]	
	2	57	65	-	005023
	3	90	98	-	005286
	4	123	131	-	005287
	5	156	164	57	005035
	6	189	197	57	005038
	8	255	263	90	005386
	10	321	329	90	005764
Connector nipple	with O-Ring, to connect from manifold				005040
Covering plate	with screws and O-ring for locking unoccupied valve positions				005630

With manifold mounting, please comply with the permissible duty cycle (5 W models with 100 % continuous rating or 8 W model with 60 % duty cycle). The pressure port for the manifold is designated with P (R), and the outlet port with A (B). Only connect together ports with the same designation.

2/2 way valves of Type 6013 can be operated together on a manifold with 3/2 way valves of Type 6014, circuit function C (not D or T!) if the operating pressures agree according to the rating plates. The manifolds can also be expanded if the valve functions are taken into consideration. Connector nipples with O-rings are used to connect the P (R) ports.

Attention!

Unused, open valve ports must be closed off with covering plates (see accessories). Manifold should be fixed on to a rail.

DTS 1000011032 EN Version: AC Status: RL (released | freigegeben | valide) printed: 10.02.2020

Ordering chart for accessories

Cable plug Type 2508 acc. to DIN EN 175301-803 Form A (previously DIN 43650)

Included in delivery is a cable plug with flat seal and fixing screw. Other versions, see Datasheet: Type 2508.

Circuit	Voltage	Article no.
without circuitry	0 - 250 V	008376
with LED	12 - 24 V	008360
with LED and varistor	12 - 24 V	008367
with LED and varistor	200 - 240 V	008369
with inverter ¹⁾	24 V DC	on request
further versions	see datasheet Type 2508	

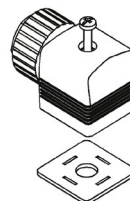

¹⁾ The inverter plug contains an electronic, which especially enables the electric 3 wire control
 Input for 3 wire technology, common “-” polarity, two split “+” polarity.
 Output suitable for impulse version for Type 6013/6014

Cable plug Type 2513 acc. to DIN EN 175301-803, Form A

Meets the requirements of ATEX category 3 GD

		Cable length [mm]	Article no. [in mm]
		12000	260893
		5000	260892
		3000	260891
		300	260890

Further versions on request

- Approval**
 UL / UR / CSA
 FM / CSA-EX Div ½
 European gas approval Class A, Group 2
- Port connection**
 Threaded port NPT, Rc
- Voltage**
 Further voltages
- Materials**
 Seal material EPDM
- Pressure**
 Variants with increased coil power for higher medium pressure

To find your nearest Burkert facility, click on the orange box → www.burkert.com

In case of special application conditions, please consult for advice.. Subject to alterations
 © Christian Bürkert GmbH & Co. KG
 1802/24_EU-en_00891729

DTS 1000011032 EN Version: AC Status: RL (released | freigegeben | valide) printed: 10.02.2020



SCATTERGOOD & JOHNSON LTD

ELECTRICAL ENGINEERING & FLUID CONTROL DISTRIBUTORS

Est.1899

At Scattergood & Johnson Ltd, we pride ourselves on being a technical distributor to specialist industries.

Working with a range of quality product suppliers across a number of specialist markets, we are not your average 'box shifter' - we are your technical and supply chain partner.

We fully support every product we sell - for free! Our internal team and external sales engineers can answer any product or application question, no matter the complexity.

Backing up this technical ability is a range of 50,000+ products available from stock for nationwide next day delivery (same day if required!), or you can collect what you need from any of our trade counters around the UK.

Select your specialist interest below to learn more about how we can help.



Online, In Branch and On the Road - Scattergood & Johnson Ltd, there when you need us.

www.scatts.co.uk