

DATA SHEET

Type 6281



Servo-assisted 2/2 way diaphragm valve

- Servo-assisted diaphragm with diameter of up to DN50
- Vibration-proof, central screwed coil system
- Damped design for quiet closing
- Service-friendly manual override
- Explosion-proof versions



Product variants described in the data sheet may differ from the product presentation and description.

Can be combined with



Type 2518
Cable Plug
DIN EN 175301 - 803 -
Form A

Type description

The 6281 valve is a servo-assisted solenoid valve of the S.EV series. A minimum differential pressure is always required for the function of the valve. Various diaphragm material combinations and methods of operation are available depending on the application. The standard brass housing satisfies all European drinking water requirements. Dezincification-resistant brass is available for other markets. The housing offering is rounded out by a stainless steel version. For reduced energy requirement, all coils can be delivered with electronic power reduction. The valve can be equipped with manual override for easy maintenance and commissioning. In combination with a plug in accordance with DIN EN 175301 - 803 Form A, the valves satisfy protection class IP65 – in combination with a stainless steel housing NEMA 4X.

Table of contents

1. General Technical Data	3
2. Circuit functions	3
3. Approvals	4
4. Materials	4
4.1. Chemical Resistance Chart – Bürkert resistApp.....	4
4.2. Material specifications standard version	4
5. Dimensions	5
5.1. Standard version.....	5
5.2. ATEX version with cable connection.....	7
5.3. ATEX version with terminal box	8
5.4. Compressor relief valves	9
6. Performance specifications	10
6.1. Power consumption	10
7. Product accessories	10
7.1. Cable glands for ATEX/IECEX terminal box	10
7.2. Special tool to turn the terminal box.....	10
8. Ordering information	11
8.1. Bürkert eShop – Easy ordering and quick delivery.....	11
8.2. Bürkert product filter.....	11
8.3. Ordering chart.....	11
Standard version with brass body	11
Standard version with stainless steel body	13
Explosion proofed version ATEX and IECEX, electrical connection with 3 m cable	14
Explosion proofed version ATEX and IECEX, electrical connection with terminal box	15
Compressor relief valve with brass body.....	16
8.4. Ordering chart accessories.....	16
Cable plug Type 2513, form A acc. to DIN EN 175301 -803	16
Cable plug Type 2518, Form A according to DIN EN 175301 -803	17
Cable glands for ATEX/IECEX terminal box	17

1. General Technical Data

Product properties	
Dimensions	Detailed information can be found in chapter "5. Dimensions" on page 5.
Material	
Body	Brass acc. to DIN EN 50930-6, stainless steel (dezincification resistant on request)
Inner valve parts	Stainless steel, Brass, Plastic (PPS)
Seal	NBR, EPDM, FKM
Nominal diameter	DN10...DN50
Thermal insulation class of solenoid	Polyamide class B Epoxy class H
Performance data	
Duty cycle	100 % continuous rating
Response times ^{1.)}	0.1...4 sec. (depending on orifice and differential pressure)
Electrical data	
Voltage tolerance	± 10 %
Operating voltage	024/DC, 024/UC, 024/50...60 V/Hz, 230/UC, 230/50...60 V/Hz
Electrical connection	Tag connector acc. to DIN EN 175301-803 Form A for cable plug Type 2518 (see "8.4. Ordering chart accessories" on page 16)
Media data	
Media	
NBR	Neutral fluids, e.g. compressed air, water
EPDM	Oil and fat-free fluids, hot water, acetone, aqueous alkali solution
FKM	Hot air, per-solution
Medium temperature	
NBR	-10 °C... +80 °C
EPDM	-30 °C... +90 °C (with epoxy coil to +100 °C)
FKM	0 °C... +90 °C (with epoxy coil to +120 °C)
Approvals and certificates	
Directives	CE, EAC
Environment and installation	
Installation	As required, preferably with actuator upright
Degree of protection	IP65 with cable plug, cable connection and terminal box
Ambient temperature (max.)	+55 °C

1.) Measured at valve outlet at 6 bar and +20 °C. Opening: pressure build-up 0...90%, Closing: pressure decay 100...10%.

2. Circuit functions

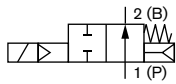
Circuit functions	Description
	Type: A, solenoid valve 2/2 way Servo-controlled Normally closed
	Type: B, solenoid valve 2/2 way Servo-controlled Normally open

3. Approvals

Explosion-proof approvals	
ATEX: EPS 18 ATEX 1232 X II 2G Ex mb IIC T4 Gb II 2D Ex mb IIIC T130 °C Db II 2G Ex eb mb IIC T4 Gb II 2D Ex mb tb IIIC T130 °C Db	IECEX: IECEx EPS 18.0110 X Ex mb IIC T4 Gb Ex mb IIIC T130 °C Db Ex eb mb IIC T4 Gb Ex mb tb IIIC T130 °C Db

4. Materials

4.1. Chemical Resistance Chart – Bürkert resistApp

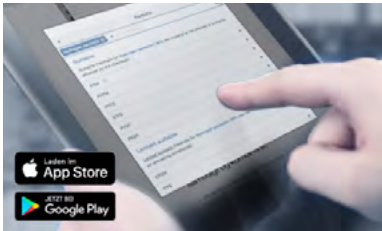

Bürkert resistApp – Chemical Resistance Chart

You want to ensure the reliability and durability of the materials in your individual application case? Verify your combination of media and materials on our website or in our resistApp.

[Start Chemical Resistance Check](#)

4.2. Material specifications standard version

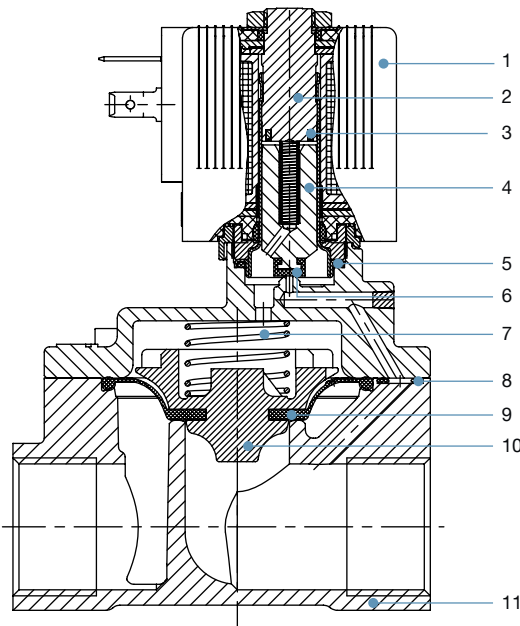

No.	Element	Material
1	Coil	Polyamide ^{1.)} or Epoxy ^{2.)}
2	Stopper	1.4113
3	Shading ring	Cu (brass version) Ag (stainless steel version)
4	Magnetic core	1.4113
5	O-rings	NBR, FKM, EPDM
6	Magnetic core	NBR, FKM, EPDM
7	Spring	1.4310
8	O-rings	NBR, FKM, EPDM
9	Diaphragm	NBR, FKM, EPDM
10	Diaphragmholder	PPSGF40, DN50: Brass and stainless steel
11	Valve body	Brass, conforming to DIN 50930-6 or stainless steel 1.4408 (CF8M)

1.) With NBR/EPDM seal
2.) With FKM seal

DTS 1000152082 EN Version: M Status: RL (released | freigegeben | validé) printed: 03.02.2020

Type 6281



5. Dimensions

5.1. Standard version

Note:

- Dimensions in mm
- The dimensions F1 and G1 apply to G-threads
- The dimensions F2 and G2 apply to NPT-threads
- The dimensions F3 and G3 apply to RC-threads

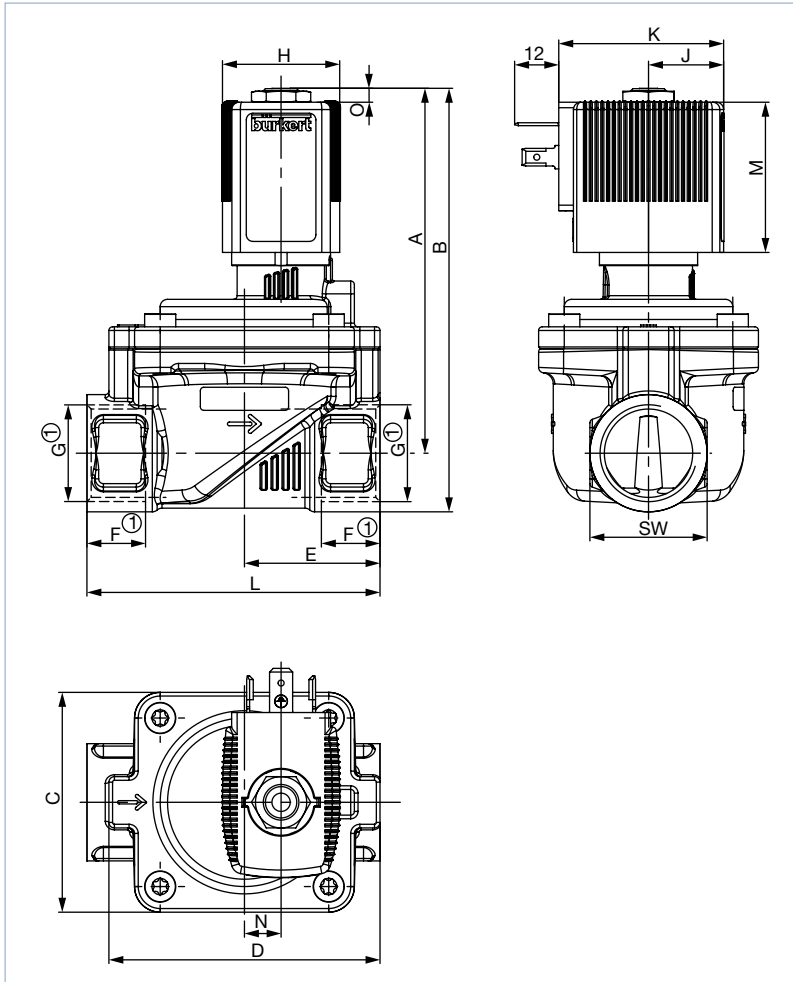

Coil size	H	J	K	M	O
5	32	20.5	45	41	3.4
6	40	23.5	51	41.4	3.8

DN	A	B	C	D	E	G		NPT		Rc		L	SW	N
						F1	G1	F2	G2	F3	G3			
10 ¹⁾	83.1	94.1	32	44	22	12	G ¼	10	NPT ¼	-	-	50	22	-
	85.1	98.6			24.5	14	G ½	13.7	NPT ½	-	-			
10 ²⁾	83.6	94.6	32	44	22	12	G ¼	10	NPT ¼	-	-	50	22	-
	85.6	99.1			24.5	14	G ½	13.7	NPT ½	-	-			
13 ¹⁾	91.1	104.6	42	54.5	27.25	12	G ¾	-	-	-	-	58	27	-
13	93.1	109.1			32.5	14	G ½	13.7	NPT ½	13.2	Rc ½	65	27	10
			37	16	G ¾	14	NPT ¾	-	-	65	32			
20	99.6	115.6	60	74	37	16	G ¾	14	NPT ¾	14.5	Rc ¾	80	32	10
	102.1	122.6			37.5	18	G 1	16.8	NPT 1	-	-			
25	106.6	127.1	70	85	46	18	G 1	16.8	NPT 1	16.8	Rc 1	95	41	15
	111.6	136.6			20	20	G 1¼	17.3	NPT 1¼	19.1	Rc 1¼			

DTS 1000152082 EN Version: M Status: RL (released | freigegeben | valide) printed: 03.02.2020

Type 6281



DN	A	B	C	D	E	G		NPT		Rc		L	SW	N
						F1	G1	F2	G2	F3	G3			
40 ^{1.)}	120.1	145.1	99	114	61	20	G 1¼	17.3	NPT 1¼	19.1	Rc 1¼	126	50	23
40	125.6	155.6			22	G 1½	NPT 1½		Rc 1½		126		60	
	131.6	166.6			64	G 2	17.6	NPT 2	23.4	Rc 2	132	70		
50 ^{1.)}	119.9	154.9	115	132	82	24	G 2	17.6	NPT 2	23.4	Rc 2	164	70	37
	119.6	162.1			89.5	27	G 2½		23.6		NPT 2½		–	

1.) Only brass threaded port version

2.) Only stainless steel threaded port version

5.2. ATEX version with cable connection

Note:

- Dimensions in mm
- The dimensions F1 and G1 apply to G-threads
- The dimensions F2 and G2 apply to NPT-threads
- The dimensions F3 and G3 apply to RC-threads
- For DN50 see dimensions "5.3. ATEX version with terminal box" on page 8

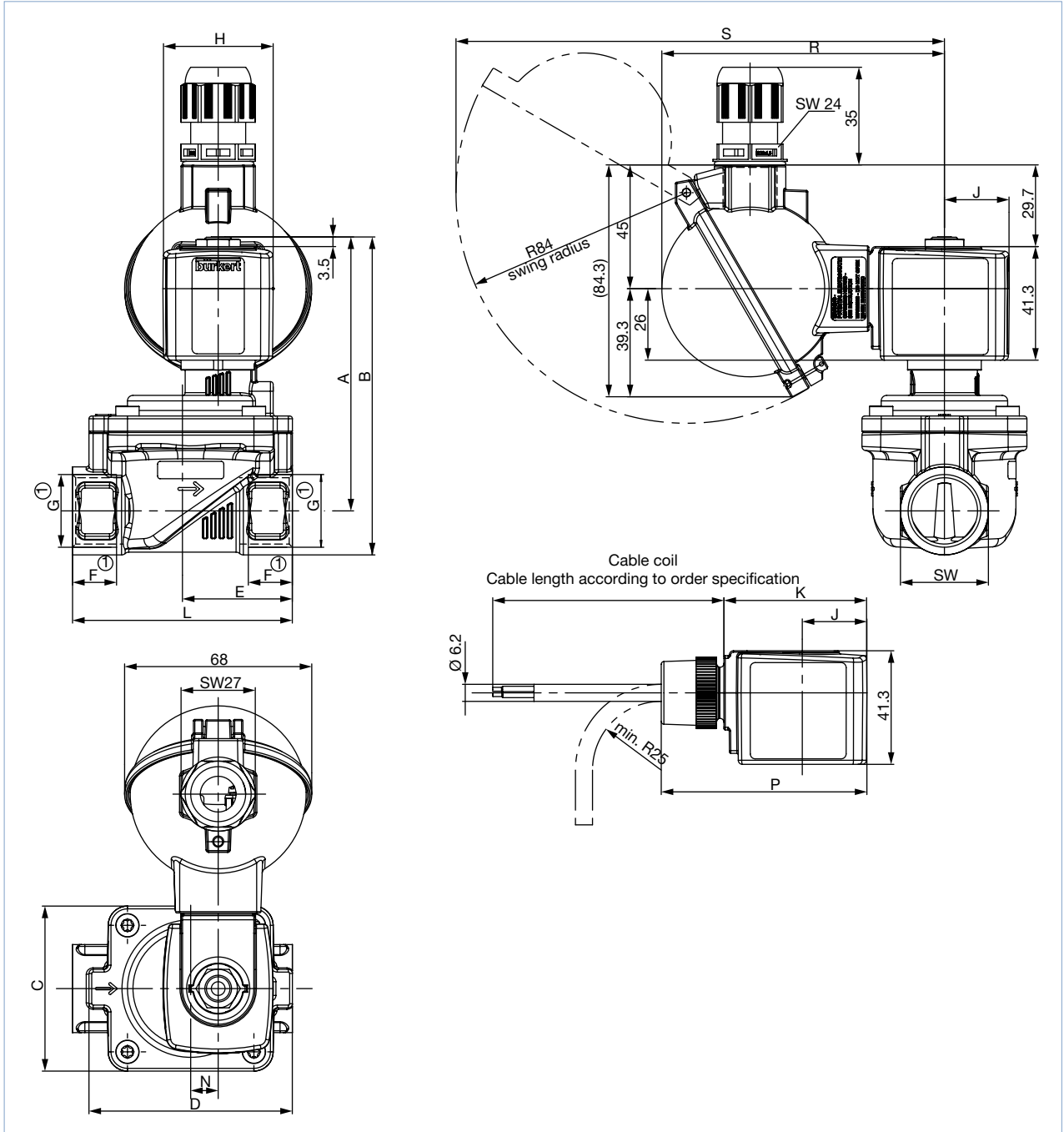

Coil size	H	J	K	P	R	S
5	32	20.5	46	68.8	99.8	174.7
6	40	23.5	52	74.8	103	177.7

Type 6281



DN	A	B	C	D	E	G		NPT		Rc		L	SW	N			
						F1	G1	F2	G2	F3	G3						
10 ¹⁾	83.1	94.1	32	44	22	12	G ¼	10	NPT ¼	-	-	50	22	-			
						12	G ⅜	10.3	NPT ⅜	10.1	Rc ⅜						
	85.1	98.6				24.5	14	G ½	13.7	NPT ½	-				-		
10 ²⁾	83.6	94.6	32	44	22	12	G ¼	10	NPT ¼	-	-	50	22	-			
						12	G ⅜	10.3	NPT ⅜	10.1	Rc ⅜						
	85.6	99.1				24.5	14	G ½	13.7	NPT ½	-				-		
13 ¹⁾	91.1	104.6	42	54.5	27.25	12	G ⅜	-	-	-	-	58	27	-			
	13					32.5	14	G ½	13.7	NPT ½	13.2				Rc ½	65	27
		93.1				109.1	16	G ¾	14	NPT ¾	-				-	65	32
20	99.6	115.6	60	74	37	16	G ¾	14	NPT ¾	14.5	Rc ¾	80	32	10			
		102.1				37.5	18	G 1	16.8	NPT 1	-				-	80	41
25	106.6	127.1	70	85	46	18	G 1	16.8	NPT 1	16.8	Rc 1	95	41	15			
		111.6				20	G 1¼	17.3	NPT 1¼	19.1	Rc 1¼				95	50	
40 ¹⁾	120.1	145.1	99	114	61	20	G 1¼	17.3	NPT 1¼	19.1	Rc 1¼	126	50	23			
40		125.6				22	G 1½		NPT 1½		Rc 1½				126	60	
		131.6				64	24	G 2	17.6	NPT 2	23.4				Rc 2	132	70
		119.9				154.9	24	G 2	17.6	NPT 2	23.4				Rc 2	164	70
50 ¹⁾	119.6	162.1	115	132	82	24	G 2½	23.6	NPT 2½	-	-	179	85	37			
		89.5				27	G 2½	23.6	NPT 2½	-	-						

5.3. ATEX version with terminal box

Note:

- Dimensions in mm
- Standard at DN50

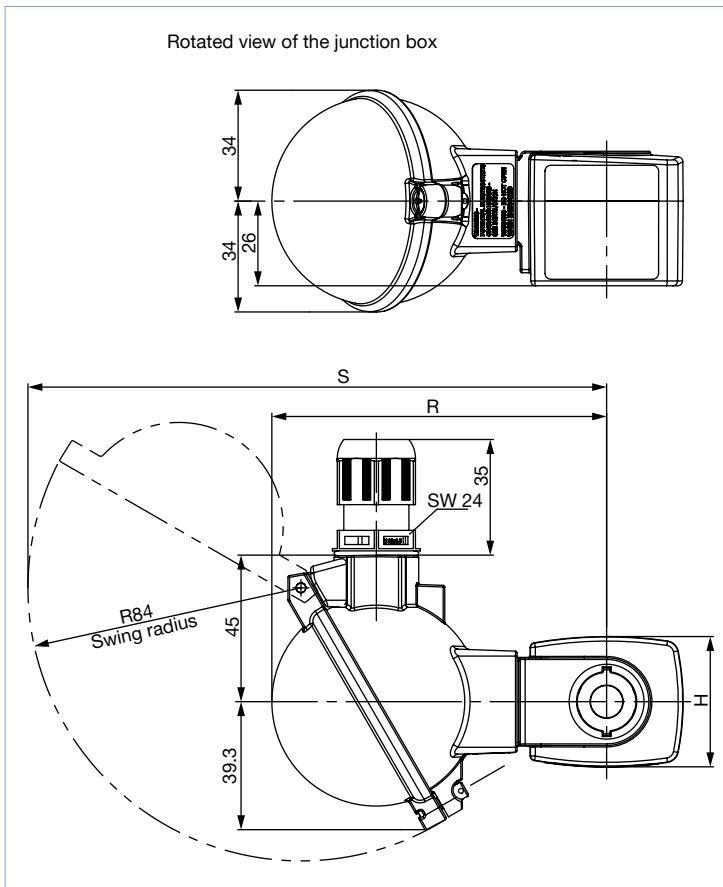

Coil size	H	J	K	P	R	S
5	32	20.5	46	68.8	99.8	174.7
6	40	23.5	52	74.8	103	177.7

DTS 1000152082 EN Version: M Status: RL (released | freigegeben | valide) printed: 03.02.2020

Visit product website ▶

Type 6281



5.4. Compressor relief valves

Note:

- Dimensions in mm
- The dimensions F1 and G1 apply to G-threads
- The dimensions F2 and G2 apply to NPT-threads
- The dimensions F3 and G3 apply to RC-threads

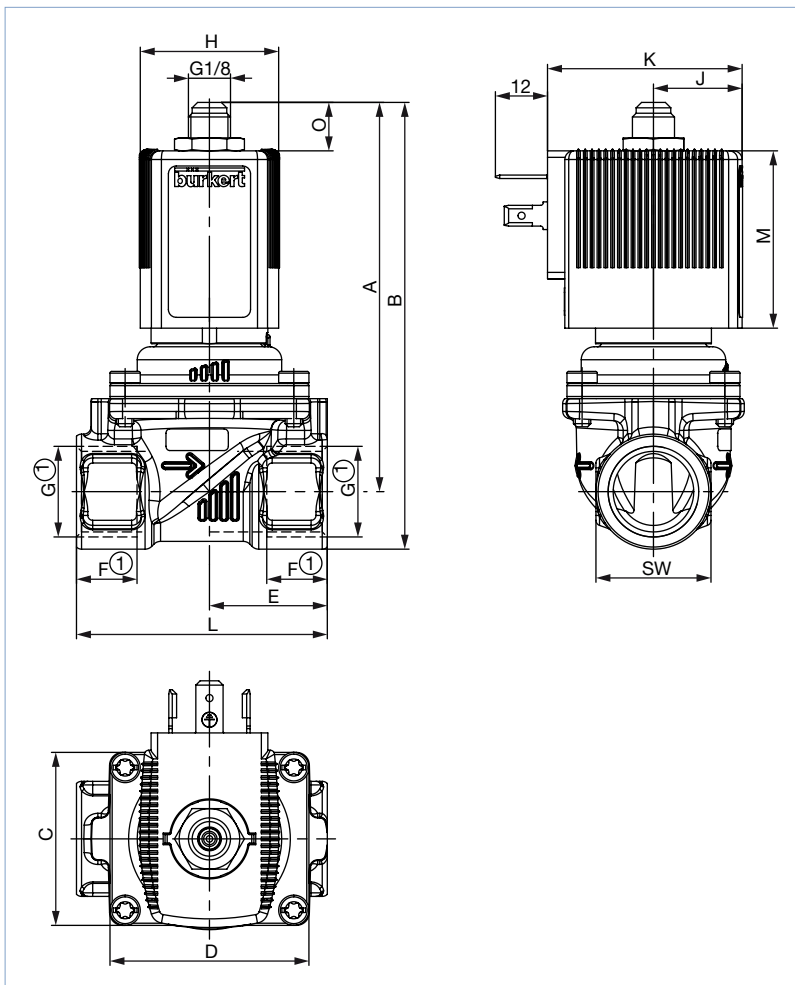

Coil size	H	J	K	M	O
5	32	20.5	46	41	11.2
6	40	23.5	52	41.4	10.8

DN	A	B	C	D	E	G		NPT		Rc		L	SW
						F1	G1	F2	G2	F3	G3		
10	90.5	101.5	32	44	22	12	G 1/4	10	NPT 1/4	-	-	50	22
						12	G 3/8	10.3	NPT 3/8	10.1	Rc 3/8		
	92.5	106			24.5	14	G 1/2	13.7	NPT 1/2	13.2	Rc 1/2		27
13	90	103.5	42	54.5	27.25	12	G 3/8	-	-	-	-	58	27
						14	G 1/2	13.7	NPT 1/2	13.2	Rc 1/2		
	92	108			32.5	16	G 3/4	14	NPT 3/4	14.5	Rc 3/4	65	32
20	107	123	60	74	37	16	G 3/4	14	NPT 3/4	14.5	Rc 3/4	80	32
	109.5	130			37.5	18	G 1	16.8	NPT 1	-	-		

DTS 1000152082 EN Version: M Status: RL (released | freigegeben | valide) printed: 03.02.2020

Type 6281

bürkert

6. Performance specifications

6.1. Power consumption



Orifice [mm]	Circuit function	Coil size [mm]	AC			DC		ATEX AC/DC
			Inrush power [VA]	Holding power [VA] [W]		Cold power [W]	Warm power [W]	Nominal power [W]
10...50	WWA	32	24	14	8	9.5	8	–
10...50	WWB	32	24	16	7	9.5	8	–
13...50	WWA / WWB	40	–	–	–	–	–	9
10	WWA	32	–	–	–	–	–	7
10	WWB	40	–	–	–	–	–	9
10	WWB u. CF05	32	18	11	5	6	5	–
13	WWB u. MX62	32	24	14	8	–	–	–
13	WWB u. MX62	40	–	–	–	11	9.5	–

7. Product accessories

7.1. Cable glands for ATEX/IECEx terminal box

Note:

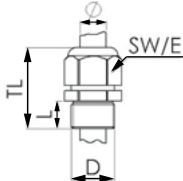
- A cable gland in polyamide version is included in the delivery. A nickel-plated brass version can be ordered at a surcharge.
- This special tool is not supplied with the valve (see “8.4. Ordering chart accessories” on page 16).

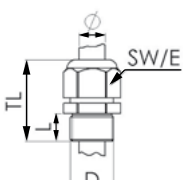
Description	Ex approvals		Dimensions										
	Certification	Identification											
Ex cable gland, Brass, nickelplated, 6...13 mm 	PTB 04 ATEX 1112 X, IECEx PTB 13.0027X	II 2 G Ex e IIC Gb, II 2 D Ex tb IIIC Db IP68	 <table border="1"> <tr><td>TL</td><td>29...37 mm</td></tr> <tr><td>L</td><td>6 mm</td></tr> <tr><td>D</td><td>20 mm</td></tr> <tr><td>SW</td><td>24 mm</td></tr> <tr><td>E</td><td>27 mm</td></tr> </table>	TL	29...37 mm	L	6 mm	D	20 mm	SW	24 mm	E	27 mm
TL	29...37 mm												
L	6 mm												
D	20 mm												
SW	24 mm												
E	27 mm												
Ex cable gland, Polyamide, 7...13 mm 	PTB 13 ATEX 1015 X, IECEx PTB 13.0034X	II 2 G Ex e IIC Gb, II 2 D Ex tb IIIC Db IP68	 <table border="1"> <tr><td>TL</td><td>36...45 mm</td></tr> <tr><td>L</td><td>10 mm</td></tr> <tr><td>D</td><td>20 mm</td></tr> <tr><td>SW</td><td>24 mm</td></tr> <tr><td>E</td><td>28 mm</td></tr> </table>	TL	36...45 mm	L	10 mm	D	20 mm	SW	24 mm	E	28 mm
TL	36...45 mm												
L	10 mm												
D	20 mm												
SW	24 mm												
E	28 mm												

7.2. Special tool to turn the terminal box

Note:

- This special tool is not supplied with the valve (see “8.4. Ordering chart accessories” on page 16).
- This special tool can only be used with ATEX AC10 coils.

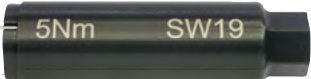
Description	Components of the set
Set SC02-AC10 	<ul style="list-style-type: none"> • Special wrench • Service manual

Visit product website ►

10 | 18

8. Ordering information

8.1. Bürkert eShop – Easy ordering and quick delivery



Bürkert eShop – Easy ordering and fast delivery

You want to find your desired Bürkert product or spare part quickly and order directly? Our online shop is available for you 24/7. Sign up and enjoy all the benefits.

[Order online now](#)

8.2. Bürkert product filter



Bürkert product filter – Get quickly to the right product

You want to select products comfortably based on your technical requirements? Use the Bürkert product filter and find suitable articles for your application quickly and easily.

[Try out our product filter](#)









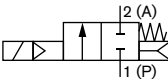

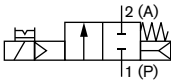























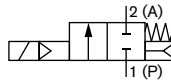

































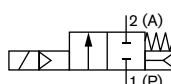













8.3. Ordering chart

Standard version with brass body

Note:

Please note that the cable plug has to be ordered separately, see [“8.4. Ordering chart accessories” on page 16](#) or separate datasheet [Type 2518](#) ▶.

Circuit function	Port connection	Orifice	K _v value water	Pressure range	Weight	Article no. per voltage/frequency [V/Hz]		
		[mm]	[m ³ /h]	[bar]	[kg]	024/DC	024/50 - 60	230/50 - 60
Seal material NBR, polyamide coil, medium temperature - 10 °C... + 80 °C								
A, solenoid valve 2/2 way Servo-controlled Normally closed 	G ¼	10	1.5	0.2...16	0.43	322499	322500	322501
	G ¾	10	1.9	0.2...16	0.40	322502	322503	322504
	G ¾	13	3.8	0.2...16	0.58	221841	221842	221843
	G ½	13	3.8	0.2...16	0.54	221844	221845	221846
	G ¾	13	3.8	0.2...16	0.59	221847	221848	221849
	G ¾	20	8.5	0.2...16	0.89	221850	221851	221852
	G 1	20	8.5	0.2...16	1.0	221853	221854	221855
	G 1	25	12	0.2...16	1.3	221856	221857	221858
	G 1¼	25	12	0.2...16	1.5	221859	221860	221861
	G 1¼	40	23	0.2...16	2.7	270131	268550	270132
	G 1½	40	30	0.2...16	3.0	221862	221863	221864
	G 2	40	30	0.2...16	3.2	221865	221866	221867
	G 2	50	40	0.2...16	4.5	253156	253157	253158
G 2½	50	40	0.2...16	5.2	253159	253160	253161	

Circuit function	Port connection	Orifice	K _v value water	Pressure range	Weight	Article no. per voltage/frequency [V/Hz]		
		[mm]	[m ³ /h]	[bar]	[kg]	024/DC	024/50-60	230/50-60
Seal material NBR, polyamide coil, medium temperature -10 °C...+80 °C, with manual override								
A, solenoid valve 2/2 way Servo-controlled, with manual mode Normally closed 	G ¼	10	1.5	0.2...16	0.43	322505 	322506 	322507 
	G ⅜	10	1.9	0.2...16	0.40	322508 	322509 	322510 
	G ½	13	3.8	0.2...16	0.54	221952 	-	221953 
	G ¾	13	3.8	0.2...16	0.59	221954 	-	221955 
	G ¾	20	8.5	0.2...16	0.89	221956 	-	221957 
	G 1	20	8.5	0.2...16	1.0	221958 	-	221959 
	G 1	25	12	0.2...16	1.3	221960 	-	221961 
	G 1¼	25	12	0.2...16	1.5	221962 	-	221963 
	G 1¼	40	23	0.2...16	2.7	270142 	-	270143 
	G 1½	40	30	0.2...16	3.0	221964 	-	221965 
	G 2	40	30	0.2...16	3.2	221966 	-	221967 
Seal material FKM, epoxy coil, medium temperature 0 °C...+120 °C								
A, solenoid valve 2/2 way Servo-controlled Normally closed 	G ¼	10	1.5	0.2...16	0.43	322511 	322512 	322513 
	G ⅜	10	1.9	0.2...16	0.40	322514 	322515 	322516 
	G ⅜	13	3.8	0.2...16	0.58	221868 	221869 	221870 
	G ½	13	3.8	0.2...16	0.54	221871 	221872 	221873 
	G ¾	13	3.8	0.2...16	0.59	221874 	221875 	221876 
	G ¾	20	8.5	0.2...16	0.89	221877 	221878 	221879 
	G 1	20	8.5	0.2...16	1.0	221880 	221881 	221882 
	G 1	25	12	0.2...16	1.3	221883 	221884 	221885 
	G 1¼	25	12	0.2...16	1.5	221886 	221887 	221888 
	G 1¼	40	23	0.2...16	2.7	270133 	270134 	270135 
	G 1½	40	30	0.2...16	3.0	221889 	221890 	221891 
	G 2	40	30	0.2...16	3.2	221892 	221893	221894
	G 2	50	40	0.2...16	4.5	253168	253169	253170
	G 2½	50	40	0.2...16	5.2	253171	253172	253173
Seal material EPDM, polyamide coil, medium temperature -30 °C...+90 °C								
A, solenoid valve 2/2 way Servo-controlled Normally closed 	G ¼	10	1.5	0.2...16	0.43	322517 	322518 	322519 
	G ⅜	10	1.9	0.2...16	0.40	322520 	322521 	322522 
	G ⅜	13	3.8	0.2...16	0.58	221895 	221896 	221897 
	G ½	13	3.8	0.2...16	0.54	221898 	221899 	221900 
	G ¾	13	3.8	0.2...16	0.59	221901 	221902 	221903 
	G ¾	20	8.5	0.2...16	0.89	221904 	221905 	221906 
	G 1	20	8.5	0.2...16	1.0	221907 	221908 	221909 
	G 1	25	12	0.2...16	1.3	221910 	221911 	221912
	G 1¼	25	12	0.2...16	1.5	221913	221914	221915
	G 1¼	40	23	0.2...16	2.7	270136	270137	270138
	G 1½	40	30	0.2...16	3.0	221916	221917	221918
	G 2	40	30	0.2...16	3.2	221919	221920	221921
	G 2	50 ^{1.)}	40	0.2...16	4.5	253162	253163	253164
	G 2½	50 ^{1.)}	40	0.2...16	5.2	253165	253166	253167

1.) Drinking water approved acc. to KTW and W270

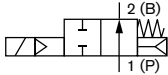
Circuit function	Port connection	Orifice	K _v value water	Pressure range	Weight	Article no. per voltage/frequency [V/Hz]		
		[mm]	[m³/h]	[bar]	[kg]	024/DC	024/50	230/50
Seal material NBR, epoxy coil, medium temperature - 10 °C... + 80 °C								
B, solenoid valve 2/2 way Servo-controlled Normally opened 	G ¼	10	1.5	0.2...16	0.43	322523	322524	322525
	G ⅜	10	1.9	0.2...16	0.40	322526	322527	322528
	G ⅝	13	3.8	0.2...16	0.58	221923	221924	221925
	G ½	13	3.8	0.2...16	0.54	221926	221928	221929
	G ¾	13	3.8	0.2...16	0.59	221930	221931	221933
	G ¾	20	8.5	0.2...16	0.89	221934	221935	221936
	G 1	20	8.5	0.2...16	1.0	221937	221938	221939
	G 1	25	12	0.2...16	1.3	221940	221941	221942
	G 1¼	25	12	0.2...16	1.5	221943	221944	221945
	G 1¼	40	23	0.2...16	2.7	270139	270140	270141
	G 1½	40	30	0.2...16	3.0	221946	221947	221948
	G 2	40	30	0.2...16	3.2	221949	221950	221951
	G 2	50	40	0.2...16	4.5	253174	253175	253176
	G 2½	50	40	0.2...16	5.2	253177	253178	253179

Standard version with stainless steel body

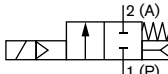
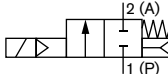
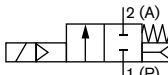
Circuit function	Port connection	Orifice	K _v value water	Pressure range	Weight	Article no. per voltage/frequency [V/Hz]		
		[mm]	[m³/h]	[bar]	[kg]	024/DC	024/50 - 60	230/50 - 60
Seal material NBR, polyamide coil, medium temperature - 10 °C... + 80 °C								
A, solenoid valve 2/2 way Servo-controlled Normally closed 	G ¼	10	1.5	0.2...16	0.43	322529	322530	322531
	G ⅜	10	1.9	0.2...16	0.40	322532	322533	322534
	G ½	13	3.8	0.2...16	0.54	221968	221969	221970
	G ¾	20	8.5	0.2...16	0.86	221971	221972	221973
	G 1	20	8.5	0.2...16	0.97	221974	221975	221976
	G 1	25	12	0.2...16	1.3	221977	221978	221979
	G 1¼	25	12	0.2...16	1.4	221980	221981	221982
	G 1½	40	30	0.2...16	2.8	221983	221984	221985
	G 2	40	30	0.2...16	3.0	221986	221987	221988
Seal material FKM, epoxy coil, medium temperature 0 °C... + 120 °C								
A, solenoid valve 2/2 way Servo-controlled Normally closed 	G ¼	10	1.5	0.2...16	0.43	322535	322536	322537
	G ⅜	10	1.9	0.2...16	0.40	322538	322539	322540
	G ½	13	3.8	0.2...16	0.54	221989	221990	221991
	G ¾	20	8.5	0.2...16	0.86	221992	221993	221994
	G 1	20	8.5	0.2...16	0.97	221995	221996	221997
	G 1	25	12	0.2...16	1.3	221998	221999	222000
	G 1¼	25	12	0.2...16	1.4	222001	222002	222003
	G 1½	40	30	0.2...16	2.8	222004	222005	222006
	G 2	40	30	0.2...16	3.0	222007	222008	222009
Seal material FKM, epoxy coil, medium temperature 0 °C... + 120 °C, with manual override								
A, solenoid valve 2/2 way Servo-controlled Normally closed 	G ¼	10	1.5	0.2...16	0.43	323894	-	323968
	G ⅜	10	1.9	0.2...16	0.40	323971	-	323972
	G ½	13	3.8	0.2...16	0.54	323973	-	323975
	G ¾	20	8.5	0.2...16	0.86	323977	-	323978
	G 1	25	12	0.2...16	1.3	323979	-	323980
	G 1¼	25	1.4	0.2...16	1.4	323982	-	323984
	G 1½	40	30	0.2...16	2.8	323986	-	323987
	G 2	40	30	0.2...16	3.0	323988	-	323989

DTS 1000152082 EN Version: M Status: RL (released | freigegeben | valide) printed: 03.02.2020

Type 6281

bürkert

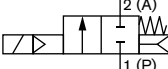
Circuit function	Port connection	Orifice	K _v value water	Pressure range	Weight	Article no. per voltage/frequency [V/Hz]		
		[mm]	[m ³ /h]	[bar]	[kg]	024/DC	024/50 - 60	230/50 - 60
Seal material EPDM, polyamide coil, medium temperature -30 °C... +90 °C								
A, solenoid valve 2/2 way Servo-controlled Normally closed 	G ¼	10	1.5	0.2...16	0.43	322541	322542	322543
	G ⅜	10	1.9	0.2...16	0.40	322544	322545	322546
	G ½	13	3.8	0.2...16	0.54	222010	222011	222012
	G ¾	20	8.5	0.2...16	0.86	222013	222014	222015
	G 1	20	8.5	0.2...16	0.97	222016	222017	222018
	G 1	25	12	0.2...16	1.3	222019	222020	222021
	G 1¼	25	12	0.2...16	1.4	222022	222023	222024
	G 1½	40	30	0.2...16	2.8	222025	222026	222027
	G 2	40	30	0.2...16	3.0	222028	222029	222031

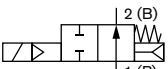
Circuit function	Port connection	Orifice	K _v value water	Pressure range	Weight	Article no. per voltage/frequency [V/Hz]		
		[mm]	[m ³ /h]	[bar]	[kg]	024/DC	024/50	230/50
Seal material FKM, epoxy coil, medium temperature 0 °C... +120 °C								
B, solenoid valve 2/2 way Servo-controlled Normally opened 	G ¼	10	1.5	0.2...16	0.43	322547	322548	322549
	G ⅜	10	1.9	0.2...16	0.40	322550	322551	322552
	G ½	13	3.8	0.2...16	0.54	228387	228388	228389
	G ¾	20	8.5	0.2...16	0.86	228390	228391	228392
	G 1	25	12	0.2...16	1.3	228393	228394	228395
	G 1¼	25	12	0.2...16	1.4	228396	228397	228398
	G 1½	40	30	0.2...16	2.8	228399	228400	228401
	G 2	40	30	0.2...16	3.0	228402	228403	228404

Explosion proofed version ATEX and IECEx, electrical connection with 3 m cable**Note:**

- The maximum fluid temperature must not in any case exceed the permissible temperature class (T4 135 °C, T5 100 °C, T6 85 °C), minus 5 K.
- Detailed information on the approvals can be found in the chapter **"3. Approvals"** on page 4.

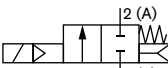
Circuit function	Port connection	Orifice	K _v value water	Pressure range	Weight	Article no. per voltage/frequency [V/Hz]	
		[mm]	[m ³ /h]	[bar]	[kg]	024/UC	230/UC
Seal material NBR, brass body, medium temperature -10 °C... +80 °C							
A, solenoid valve 2/2 way Servo-controlled Normally closed 	G ¼	10	1.5	0.2...16	0.62	349656	349658
	G ⅜	10	1.9	0.2...16	0.59	349660	349662
	G ½	13	3.8	0.2...16	0.84	349690	349696
	G ¾	20	8.5	0.2...16	1.2	349717	349719
	G 1	25	12	0.2...16	1.7	349731	349734
	G 1¼	25	12	0.2...16	1.8	349737	349739
	G 1¼	40	23	0.2...16	3.0	349751	349754
	G 1½	40	30	0.2...16	3.3	349756	349758
	G 2	40	30	0.2...16	3.5	349760	349762
	G 2	50	40	0.2...16	4.8	349773	349775
	G 2½	50	40	0.2...16	5.5	349777	349778

Visit product website ►

14 | 18

Type 6281

bürkert

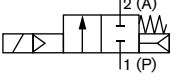
Circuit function	Port connection	Orifice	K _v value water	Pressure range	Weight	Article no. per voltage/frequency [V/Hz]	
		[mm]	[m ³ /h]	[bar]	[kg]	024/UC	230/UC
Seal material FKM, stainless steel body, medium temperature 0 °C... +90 °C							
A, solenoid valve 2/2 way Servo-controlled Normally closed 	G ¼	10	1.5	0.2...16	0.62	349665	349666
	G ⅜	10	1.9	0.2...16	0.59	349669	349670
	G ½	13	3.8	0.2...16	0.84	349707	349708
	G ¾	20	8.5	0.2...16	1.2	349724	349727
	G 1	25	12	0.2...16	1.6	349742	349744
	G 1¼	25	12	0.2...16	1.7	349747	349750
	G 1½	40	30	0.2...16	3.1	349765	349767
	G 2	40	30	0.2...16	3.3	349770	349771

Explosion proofed version ATEX and IECEx, electrical connection with terminal box**Note:**

- The maximum fluid temperature must not in any case exceed the permissible temperature class (T4 135 °C, T5 100 °C, T6 85 °C), minus 5 K.
- Detailed information on the approvals can be found in the chapter **"3. Approvals"** on page 4.

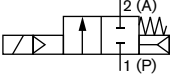
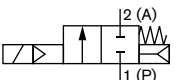
Circuit function	Port connection	Orifice	K _v value water	Pressure range	Weight	Article no. per voltage/frequency [V/Hz]	
		[mm]	[m ³ /h]	[bar]	[kg]	024/UC	230/UC
Seal material NBR, brass body, medium temperature -10 °C... +80 °C							
A, solenoid valve 2/2 way Servo-controlled Normally closed ^{1.)} 	G ¼	10	1.5	0.2...16	0.62	349657	349659
	G ⅜	10	1.9	0.2...16	0.59	349661	349663
	G ½	13	3.8	0.2...16	0.84	349691	349697
	G ¾	20	8.5	0.2...16	1.2	349718	349720
	G 1	25	12	0.2...16	1.7	349733	349735
	G 1¼	25	12	0.2...16	1.8	349738	349740
	G 1¼	40	23	0.2...16	3.0	349753	349755
	G 1½	40	30	0.2...16	3.3	349757	349759
	G 2	40	30	0.2...16	3.5	349761	349763
	G 2	50	40	0.2...16	4.8	349774	349776
Seal material FKM, stainless steel body, medium temperature 0 °C... +90 °C							
A, solenoid valve 2/2 way Servo-controlled Normally closed ^{1.)} 	G ¼	10	1.5	0.2...16	0.62	349664	349667
	G ⅜	10	1.9	0.2...16	0.59	349668	349671
	G ½	13	3.8	0.2...16	0.84	349705	349709
	G ¾	20	8.5	0.2...16	1.2	349725	349728
	G 1	25	12	0.2...16	1.6	349743	349745
	G 1¼	25	12	0.2...16	1.7	349748	349749
	G 1½	40	30	0.2...16	3.1	349766	349768
	G 2	40	30	0.2...16	3.3	349769	349772

1.) Only with Epoxy coil available

Type 6281



Compressor relief valve with brass body

Note:

- Please note that the cable plug has to be ordered separately, see “8.4. Ordering chart accessories” on page 16 or separate datasheet **Type 2518** ▶.
- In deenergized state the valve is open. The medium also flows off via the vent on the coil.

Circuit function	Port connection	Orifice	K _v value water	Pressure range	Weight	Article no. per voltage/frequency [V/Hz]				
		[mm]	[m ³ /h]	[bar]	[kg]	024/DC	024/50 - 60	110/50 - 60	230/50 - 60	
Seal material FKM, polyamide coil, medium temperature 0 °C... +90 °C, DN10_CFO5										
B, solenoid valve 2/2 way Servo-controlled Normally opened	G 3/8	10	1.9	0.2...16	0.43	330985	330986	330987	330988	
	G 1/2	10	1.9	0.2...16	0.40	330989	331007	331008	331009	
Seal material FKM, polyamide coil, medium temperature 0 °C... +90 °C, DN13										
B, solenoid valve 2/2 way Servo-controlled Normally opened	G 3/8	13	3.6	0.5...16	0.58	310663	310662	310661	310659	
	G 1/2	13	3.6	0.5...16	0.54	310667	310666	310665	310664	

Further versions on request	
Material Brass dezincification resistant	Temperature <ul style="list-style-type: none"> • EPDM version up to +100 °C with epoxy coil • FKM version up to +120 °C with epoxy coil
Process connection NPT, Rc	Approval <ul style="list-style-type: none"> • European drinking water approval acc. to KTW W270 (Var. code PF23) • VDE sign permission acc. to DIN EN 60730 (Var. code PW01) • UL-Zulassung UL429 (Var. Code PE94/PE95) • Schiffahrtszulassung DNV-GL (Var. Code PD07)
Voltage Furhter voltages	

8.4. Ordering chart accessories

Cable plug Type 2513, form A acc. to DIN EN 175301 - 803

Note:

- The Cable plug Type 2513 meets the requirements of ATEX category 3 GD.
- For more information on the cable plug, see data sheet **Type 2513** ▶.

Cable plug	circuit diagram	Cable length [mm]	Article no.
		12000	260893
		5000	260892
		3000	260891
		300	260890

Visit product website ▶

DTS 1000152082 EN Version: M Status: RL (released | freigegeben | valide) printed: 03.02.2020

Type 6281



Cable plug Type 2518, Form A according to DIN EN 175301 -803

Note:

Further versions see data sheet **Type 2518** ▶.

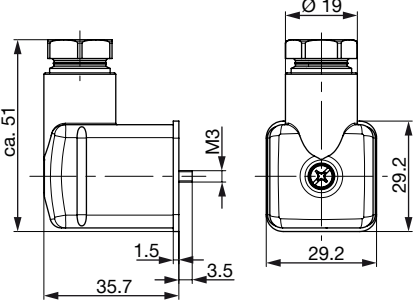
Cable plug	Dimensions	Version	Voltage	Article no.
		Without circuitry (AC/DC)	0...250 V AC/DC	314802
		With LED (AC/DC)	12...24 V AC/DC	314812
		With LED and varistor (AC/DC)	12...24 V AC/DC	314820
		With rectifier, LED and varistor	12...24 V AC/DC	314816

Cable glands for ATEX/IECEx terminal box

Note:

- A cable gland in polyamide version is included in the delivery. A nickel-plated brass version can be ordered at surcharge.
- For more information on Ex cable glands, see **"6.1. Cable glands for ATEX/IECEx terminal box"** on page 12.
- For more information on Special wrench see **"7.2. Special tool to turn the terminal box"** on page 10.

Description	Article no.
Ex cable gland, brass, nickelplated, 6...13 mm ^{1.)}	773278
Ex cable gland, polyamide, 7...13 mm ^{1.)}	773277
Set SC02-AC10: Special wrench ^{2.)} incl. service manual	293488

1.) Cable diameter

2.) Not included in the scope of delivery of the valve

Mounting set for DN10

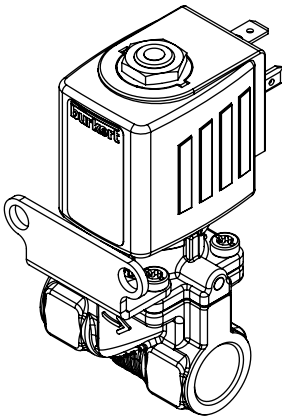
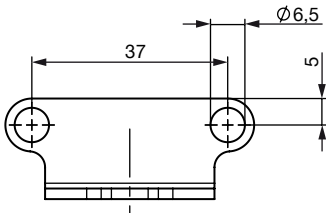
Mounting set	Dimensions	Description	Article no.
		Bestehend aus Befestigungswinkel und Schrauben	365730

DTS 1000152082 EN Version: M Status: RL (released | freigegeben | validé) printed: 03.02.2020

Bürkert – Close to You

For up-to-date addresses
please visit us at
www.burkert.com

DTS 1000152082 EN Version: M Status: RL (released | freigegeben | validé) printed: 03.02.2020



Credits, © and concept: Christian Bürkert GmbH & Co. KG | Photographs: Marc Eggimann Fotografie - 4051 Basel | Scanner GmbH - Werbeagentur Künzelsau - 74653 Künzelsau



SCATTERGOOD & JOHNSON LTD

ELECTRICAL ENGINEERING & FLUID CONTROL DISTRIBUTORS

Est.1899

At Scattergood & Johnson Ltd, we pride ourselves on being a technical distributor to specialist industries.

Working with a range of quality product suppliers across a number of specialist markets, we are not your average 'box shifter' - we are your technical and supply chain partner.

We fully support every product we sell - for free! Our internal team and external sales engineers can answer any product or application question, no matter the complexity.

Backing up this technical ability is a range of 50,000+ products available from stock for nationwide next day delivery (same day if required!), or you can collect what you need from any of our trade counters around the UK.

Select your specialist interest below to learn more about how we can help.



Online, In Branch and On the Road - Scattergood & Johnson Ltd, there when you need us.

www.scatts.co.uk