

Cable Duct ASi Motor Modules

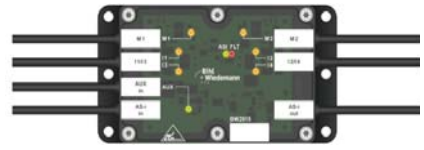

Cable Duct ASi Motor Modules for two 24 V Motorized Rollers Itoh Denki (PM500ME/XE/XP, PM605ME/XE/XP)

- ASi and AUX via M8 connectors
- ASi and AUX via profile cable



Flat design,
optimized for use in cable channels

Inputs and Outputs in one module

Speed setting via ASi parameters



(Figure similar)



Figure	Drive ⁽¹⁾	Number of drives	Line protection fuse ⁽²⁾	Inputs digital	Outputs digital	Outputs analog	Input voltage (sensor supply) ⁽³⁾	Output voltage (actuator supply) ⁽⁴⁾	Connection	ASi connection ⁽⁵⁾	Round cable	Article No.
	Itoh Denki	2	yes	4	4	2	out of ASi	out of AUX	2 x M8 cable sockets, straight, 5 poles + 2 x M8 cable sockets, straight, 4 poles	ASi profile cable	Motor: 0,40 m, Input: 0,06 m	BWU3278
	Itoh Denki	2	yes	4	4	2	out of ASi	out of AUX	2 x M8 cable sockets, straight, 5 poles + 2 x M8 cable sockets, straight, 4 poles	ASi profile cable	Motor: 0,40 m, Input: 0,40 m	BWU3567
	Itoh Denki	2	yes	4	4	2	out of ASi	out of AUX	2 x M8 cable sockets, straight, 5 poles + 2 x M12 cable sockets, straight, 5 poles	ASi profile cable	Motor: 0,40 m, Input: 0,06 m	BWU3679
	Itoh Denki	2	yes	4	4	2	out of ASi	out of AUX	2 x M8 cable sockets, straight, 5 poles + 2 x M8 cable sockets, straight, 4 poles	ASi via M8	Motor: 0,40 m, Input: 0,06 m, ASi: 0,85 m, AUX: 0,10m	BW2915

(1) **Itoh Denki (PM500ME/XE/XP, PM605ME/XE/XP):**

Motor module to control 24 V motorized rollers Itoh Denki Serie Power Moller® 500ME/XE/XP and Serie Power Moller® 605ME/XE/XP.

(2) **yes, separately for each motor, 3,5 A (slow-blow fuse):**

In the motor module UL approved fuses are placed before each of the motor supply connections. A short circuit in the motor causes this fuse to blow, protecting the connection cable between the module and motor.

After blowing the fuse the module is no longer functional and needs to be replaced. The characteristics of the fuse must be checked against the motor data before using the module.

The protection circuit in the module allows a very simple protection of the motor cables. The fuse for the cable protection is a slow-blow one; without short circuit the robust behavior of the module remains.

(3) **Input voltage (sensor supply):**

Inputs are supplied by ASi or by AUX (auxiliary 24 V power). If supplied by ASi, inputs shall not be connected to earth or to external potential.

(4) **Output voltage (actuator supply):**

Outputs are supplied by ASi or by AUX (auxiliary 24 V power). If supplied by ASi, outputs shall not be connected to earth or to external potential.

(5) **ASi connection:**

The connection to ASi as well to AUX (auxiliary 24 V power) is made via yellow resp. black ASi profile cable with piercing technology or via M8 socket.

Cable Duct ASi Motor Modules



Article No.	BWU3679	BWU3278	BWU3567	BW2915
General data				
Motorized roller type	2 x Itoh Denki (PM500ME/XE/XP, PM605ME/XE/XP)			
Connection				
ASi/AUX connection	profile cable and piercing			M8
Periphery connection	M8/M12	M8		
ASi				
Profile	S-7.A.7, ID1 = 7 (fixed)			
Address	1 AB slave			
Required Master profile	≥M4			
As of ASi specification	3.0			
Operating voltage	30 V (18 ... 31.6 V)			
Max. current consumption	200 mA			
AUX				
Operating voltage	24 V (18 ... 30V)			
Max. current consumption	up to +40 °C	6 A continuously, 11 A peak ⁽¹⁾		
	at +55 °C	4,4 A continuously, 8 A peak ⁽¹⁾		
Input				
Number	4			
Power supply	sensor inputs: out of ASi			
Sensor supply	short-circuit and overload protected according to EN 61131-2			
Power supply of attached sensors	up to +30 °C	120 mA ⁽²⁾		
	at +40 °C	100 mA ⁽²⁾		
	at +50 °C	60 mA ⁽²⁾		
	at +55 °C	40 mA ⁽²⁾		
Switching threshold	U _{in} < 5 V (low) U _{in} > 10 V (high)			
Output				
Number (digital)	4			
	short-circuit and overload protected according to EN 61131-2			
Number (analog)	2			
Power supply	out of AUX (galvanic separation)			
Overvoltage tolerated by reaction (AUX)	35 V resistant brake resistor compatible			
Max. output current	up to +50 °C	10 mA per output, ∑ (out) 40 mA ⁽³⁾		
	at +55 °C	10 mA per output, ∑ (out) 25 mA ⁽³⁾		
Motor supply	up to +40 °C	out of AUX, 3 A continuously, 5,5 A max. ⁽¹⁾		
	at +55 °C	out of AUX, 2,2 A continuously, 4 A max ⁽¹⁾		
Line protection fuse	yes, separately for each motor, 3.5 AT, at 7 A (200%) release between 1 s and 120 s, fuse UL certified ⁽⁴⁾			
Display				
LED I1 ...I _x (yellow)	state of inputs I1 ... I4			
LED M1, M2 (yellow)	state of outputs M1 (O1), M2 (O3)			
LED ASi (green)	on: ASi voltage on off: no ASi voltage			
LED AUX (green)	on: 24 V _{DC} AUX off: no 24 V _{DC} AUX			
LED FLT/FAULT (red)	on: slave address 0 or slave offline flashing: AUX voltage is missing, overload output, an output is short circuited, at least one motor fuse has blown or overload sensor off: slave online			

Cable Duct ASi Motor Modules



Article No.	BWU3679	BWU3278	BWU3567	BW2915
Environment				
Applied standards	EN 61000-6-2 EN 61000-6-4 EN 61131-2 EN60529			
Operating altitude	max. 2000 m			
Ambient temperature	-5 °C ... +40 °C (up to max. 55 °C) ⁽¹⁾⁽²⁾⁽³⁾			
	If the cables are fixed installed: -30 °C ... +40 °C (up to max. 55 °C) ⁽¹⁾⁽²⁾⁽³⁾⁽⁵⁾ no condensation permissible			
Storage temperature	-25 °C ... +85 °C			
Housing	plastic, screw mounting			
Pollution Degree	2			
Protection category	IP54			
Tolerable loading referring to humidity	according to EN 61131-2			
Weight	module: 200 g passive distributor: 75 g			module: 200 g
Dimensions (W / H / D) in mm	module: 90 / 60 / 18 passive distributor: 60 / 45 / 19			module: 90 / 60 / 18

(1)

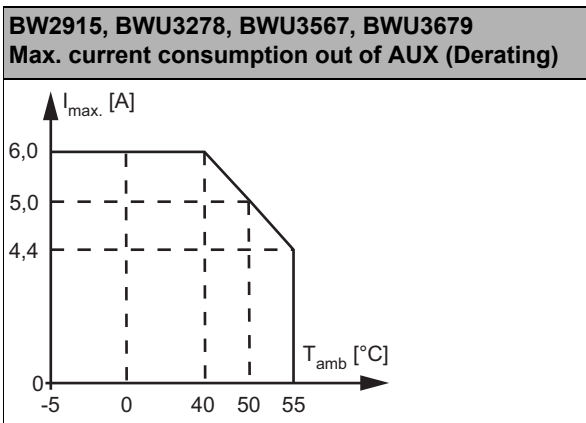

(2)

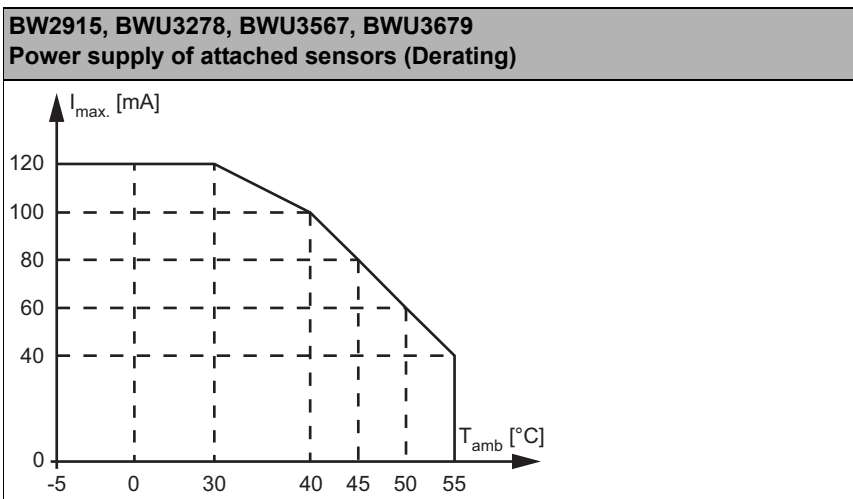

Cable Duct ASi Motor Modules

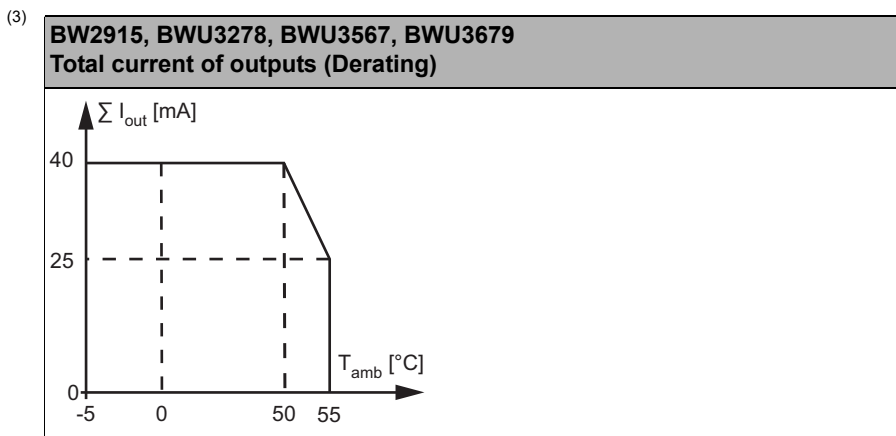

(4) In the motor module UL approved fuses are placed before each of the motor supply connections. A short circuit in the motor causes this fuse to blow, protecting the connection cable between the module and motor. After blowing the fuse the module is no longer functional and needs to be replaced. The characteristics of the fuse must be checked against the motor data before using the module. The protection circuit in the module allows a very simple protection of the motor cables. The fuse for the cable protection is a slow-blow one; without short circuit the robust behavior of the module remains.

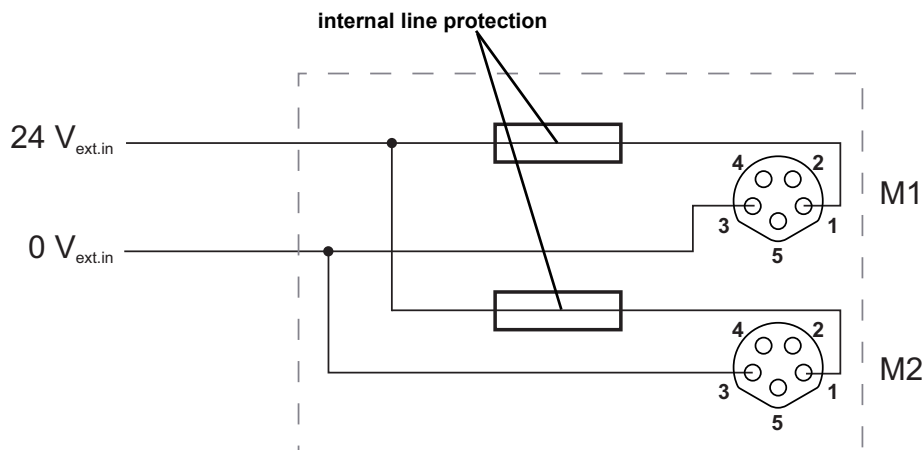

(5) -30 °C from Ident.No. ≥16382 (BWU3278); Ident.No. ≥16383 (BW2915).

Configuration analog value BW2915, BWU3278, BWU3567, BWU3679

ASi parameters			analog value Pin 5	
P0	P1	P2	DO1=1 (fast)	DO1=0 (slow)
0	0	0	1,5 V	0 V
1	0	0	3,5 V	1,5 V
0	1	0	4,5 V	2,5 V
1	1	0	5,5 V	2,5 V
0	0	1	6,5 V	3,5 V
1	0	1	7,5 V	3,5 V
0	1	1	8,5 V	4,5 V
1	1	1	10 V	5,5 V

Cable Duct ASi Motor Modules

Bit assignment BW2915, BWU3278, BWU3567, BWU3679

Data bit		Function
DI0	I1	input I1
DI1	I2	input I2
DI2	I3	input I3
DI3	I4	input I4
DO0	O1	motor 1: start / stop
DO1	internal	motors 1+2: fast (DO1=1) / slow (DO1=0)
DO2	O3	motor 2: start / stop
DO3	O2, O4	motors 1+2: direction

Article No.	Connection	Name / Number	Cable length	Pin1	Pin2	Pin3	Pin4	Pin5
BWU3278	M8, 5 poles 	M1 (Motor 1)	40 cm	24 V _{ext out}	O2 (0: 0 V; 1: 24 V)	0 V _{ext out}	O1 (0: 0 V; 1: 24 V)	analog value
		M2 (Motor 2)			O4 (0: 0 V; 1: 24 V)		O3 (0: 0 V; 1: 24 V)	analog value
	M8, 4 poles 	I1/I3	6 cm	24 V _{out of ASi}	I3	0 V _{out of ASi}	I1	-
		I2/I4			I4		I2	
BWU3567	M8, 5 poles 	M1 (Motor 1)	40 cm	24 V _{ext out}	O2 (0: 0 V; 1: 24 V)	0 V _{ext out}	O1 (0: 0 V; 1: 24 V)	analog value
		M2 (Motor 2)			O4 (0: 0 V; 1: 24 V)		O3 (0: 0 V; 1: 24 V)	analog value
	M8, 4 poles 	I1/I3	40 cm	24 V _{out of ASi}	I3	0 V _{out of ASi}	I1	-
		I2/I4			I4		I2	
BWU3679	M8, 5 poles 	M1 (Motor 1)	40 cm	24 V _{ext out}	O2 (0: 0 V; 1: 24 V)	0 V _{ext out}	O1 (0: 0 V; 1: 24 V)	analog value
		M2 (Motor 2)			O4 (0: 0 V; 1: 24 V)		O3 (0: 0 V; 1: 24 V)	analog value
	M12, 5 poles 	I1/I3	6 cm	24 V _{out of ASi}	I3	0 V _{out of ASi}	I1	-
		I2/I4			I4		I2	

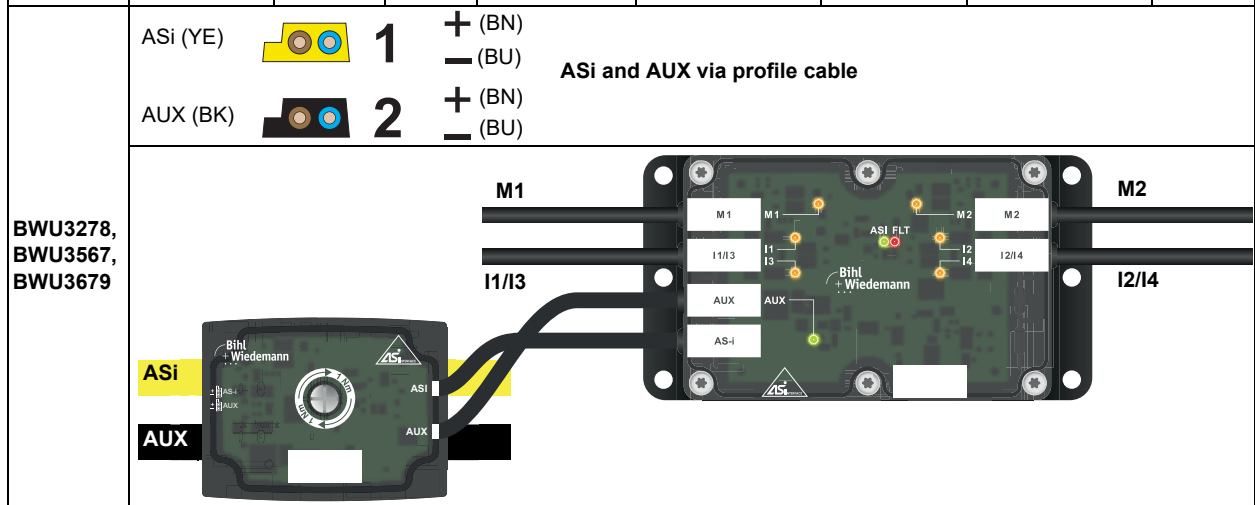

Cable Duct ASi Motor Modules

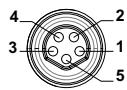
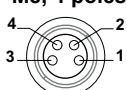
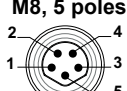
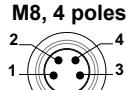
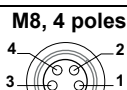
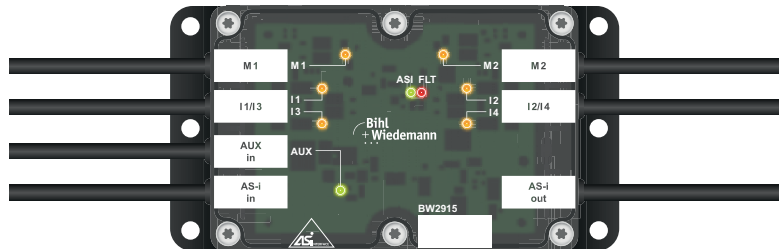

Article No.	Connection	Name / Number	Cable length	Pin1	Pin2	Pin3	Pin4	Pin5
BW2915	M8, 5 poles 	M1 (Motor 1)	40 cm	24 V _{ext out}	O2 (0: 0 V; 1: 24 V)	0 V _{ext out}	O1 (0: 0 V; 1: 24 V)	analog value
		M2 (Motor 2)			O4 (0: 0 V; 1: 24 V)		O3 (0: 0 V; 1: 24 V)	analog value
	M8, 4 poles 	I1/I3	6 cm	24 V _{out of ASi}	I3	0 V _{out of ASi}	I1	-
		I2/I4			I4		I2	
	M8, 5 poles 	AUX _{in}	10 cm	24 V _{ext in}	24 V _{ext in}	0 V _{ext in}	0V _{ext in}	n.c.
M8, 4 poles 	ASi _{in}	85 cm	ASi+	ASi+	ASi-	ASi-	-	
M8, 4 poles 	ASi _{out}							
BW2915								

Accessories:

- for BW2915:
 - passive distributor (article no. BW3276)
- for BWU3278, BWU3567, BWU3679:
 - ASi connecting cable for addressing with a hand held address programming device (article no. BW3304)
 - ASi connecting cable for addressing with ASi gateways (article no. BW3305)



SCATTERGOOD & JOHNSON LTD

ELECTRICAL ENGINEERING & FLUID CONTROL DISTRIBUTORS

Est.1899

At Scattergood & Johnson Ltd, we pride ourselves on being a technical distributor to specialist industries.

Working with a range of quality product suppliers across a number of specialist markets, we are not your average 'box shifter' - we are your technical and supply chain partner.

We fully support every product we sell - for free! Our internal team and external sales engineers can answer any product or application question, no matter the complexity.

Backing up this technical ability is a range of 50,000+ products available from stock for nationwide next day delivery (same day if required!), or you can collect what you need from any of our trade counters around the UK.

Select your specialist interest below to learn more about how we can help.



Online, In Branch and On the Road - Scattergood & Johnson Ltd, there when you need us.

www.scatts.co.uk