

ASi Safety Input Modules, IP20



ASi Safety Input Modules, IP20

- for optoelectronic protective devices, floating contacts or safety mats
- for antivalent optoelectronic protective devices and floating contacts



(Figure similar)



Figure	Type	Housing	Inputs Safety, SIL 3, Cat. 4	Outputs digital	Safety signal inputs	Input voltage (sensor supply.) (1)	Output voltage (actuator supply) (2)	ASi address (3)	Article no.
	IP20, 22,5 mm x 50 mm, 3 x COMBICON, Safety	3 x COMBICON	1 x 2 channels	2 x electronic	floating contacts	out of ASi	out of AUX	1 single slave	BWU1939
	IP20, 22,5 mm x 50 mm, 3 x COMBICON, Safety	3 x COMBICON	1 x 2 channels	2 x electronic	floating contacts	out of ASi	out of ASi	1 single slave	BWU2724
	IP20, 22,5 mm x 50 mm, 3 x COMBICON, Safety	3 x COMBICON	1 x 2 channels SIL 2, Cat. 3	2 x electronic	safety mats 1.2 kΩ or 8.2 kΩ monitoring resistor	out of AUX	out of AUX	1 single slave	BWU2661
	IP20, 22,5 mm x 50 mm, 3 x COMBICON, Safety	3 x COMBICON	1 x 2 channels	2 x electronic	opto-electronic protective devices	out of AUX	out of AUX	1 single slave	BWU2577
	IP20, 22,5 mm x 114 mm, 4 x COMBICON, Safety	4 x COMBICON	1 x 2 channels	2 x electronic	floating contacts	out of AUX	out of AUX	1 single slave	BWU3013
	IP20, 22,5 mm x 114 mm, 4 x COMBICON, Safety	4 x COMBICON	2 x 2 channels	4 x electronic	floating contacts	out of AUX	out of AUX	2 single slaves	BWU2707
	IP20, 22,5 mm x 114 mm, 4 x COMBICON, Safety	4 x COMBICON	2 x 2 channels	–	floating contacts + antivalent opto-electronic protective devices	out of AUX	–	2 single slaves	BWU3671
	IP20, 22,5 mm x 114 mm, 4 x COMBICON, Safety	4 x COMBICON	2 x 2 channels	–	floating contacts + opto-electronic protective devices	out of AUX	–	2 single slaves	BWU3696

- (1) **Input voltage (sensor supply):** inputs are supplied by ASi or by AUX (auxiliary 24 V power). If supplied by ASi, inputs shall not be connected to earth or to external potential.
- (2) **Output voltage (actuator supply):** outputs are supplied by ASi or by AUX (auxiliary 24 V power). If supplied by ASi, outputs shall not be connected to earth or to external potential.
- (3) **ASi address:**
 AB Slave (max. 62 AB Slaves/ASi network), 2 AB Slaves (max. 31 modules with 2 AB Slaves), Single Slaves (max. 31 Single Slaves/ASi network), mixed use allowed.

ASi Safety Input Modules, IP20



Article no.	BWU2724	BWU1939	BWU2707	BWU3013	
Connection					
ASi / AUX Connection	COMBICON plugs, push-in terminals ⁽¹⁾				
Periphery connection	COMBICON plugs, push-in terminals ⁽¹⁾				
Length of connector cable	I/O: max. 15 m		unlimited ⁽⁶⁾		
ASi					
Profile	S-7.B.0, ID1=F		SL 1: S-7.B.0, ID1=F SL 2: S-7.B.0, ID1=E	S-7.B.0, ID1=F	
Address	1 single slave		2 single slaves	1 single slave	
Operating voltage	30 V _{DC} (22 ... 31,6 V)				
Required Master profile	≥M3				
Since ASi specification	2.1				
Max. current input	100 mA	80 mA	60 mA	35 mA	
AUX					
Voltage	–	24 V _{DC} (20 ... 30 V)			
Max. current input	–	1,5 A at output short-circuit	4 A max.		
Input					
Number	1 x 2-channels safe input		2 x 2-channels safe inputs	1 x 2-channels safe input	
Safety signal inputs	floating contacts				
Switching current	static 4 mA at 24 V, dynamic 15 mA at 24 V (T = 100 μs)				
Power supply	out of ASi		out of AUX		
Switching threshold	10 mA, R < 150 Ω				
Output					
Number	2, electronic, short circuit protected		4, electronic, short circuit protected	2, electronic, short circuit protected	
Power Supply	out of ASi		out of AUX		
Max. output current	up to 40 °C	Σ(Out) 50 mA ⁽²⁾	200 mA per output	1 A per output, Σ(Out) 3 A ⁽⁷⁾ ⁽⁸⁾	1 A per output ⁽⁸⁾
	at 45 °C			0,5 A per output, Σ(Out) 1,5 A ⁽⁷⁾ ⁽⁸⁾	0,5 A per output ⁽⁸⁾
	at 55 °C	–	–		
	at 70 °C	Σ(Out) 0 mA ⁽²⁾	–	–	

ASi Safety Input Modules, IP20



Article no.	BWU2724	BWU1939	BWU2707	BWU3013
Display				
LED ASI (green)	on: ASi voltage on flashing: ASi voltage on, but peripheral fault ⁽³⁾ or address 0 off: no ASi voltage	on: ASi power supply on		
LED FLT/FAULT (red)	on: no data exchange flashing: peripheral fault ⁽³⁾			
LED ASI/FLT (red/green)	–	green: slave online red: no data exchange yellow/red flashing: address 0 red/green flashing: peripheral fault ⁽³⁾		
LED ASI/FLT2 (red/green)	–	green: slave online red: no data exchange yellow/red flashing: address 0 red/green flashing: peripheral fault ⁽³⁾ red flashing: slave 2 is switched off, because slave 1 is offline	–	
LED AUX (green)	–	on: 24 V _{DC} AUX off: no 24 V _{DC} AUX		
LED CC (red)	cross connection ⁽³⁾			
LEDs O1 ... On (yellow)	state of outputs O1, O2		state of outputs O1 ... O4	state of outputs O1, O2
LED S1 ... Sn (yellow)	state of inputs S1, S2		state of inputs S1 ... S4	state of inputs S1, S2
Environment				
Applied standards	EN 60529 EN ISO 13849-2 EN 61000-6-2 EN 61000-6-4 EN 61131-2 EN 62026-2 EN 62061 SIL3 EN ISO 13849-1 PLe cat 4			
Operating altitude	max. 2000 m			
Ambient temperature	-30 °C ... +55 °C (up to max. +70 °C) ⁽²⁾ ⁽⁴⁾ ⁽⁵⁾ ⁽⁷⁾ ⁽⁸⁾ no condensation permitted			
Storage temperature	-25 °C ... +85 °C			
Housing	plastic, for DIN rail mounting			
Pollution Degree	2			
Protection category	IP20			
Tolerable loading referring to humidity	according to EN 61131-2			
Allowable shock and vibration stress	≤ 15 g, T ≤ 11 ms 10 ... 55 Hz, 0,5 mm amplitude			
Weight	60 g		160 g	
Dimensions (W / H / D in mm)	22,5 / 99,6 / 50,5		22,5 / 99,6 / 114	

⁽¹⁾ see table "Wiring rules"

ASi Safety Input Modules, IP20



(2)

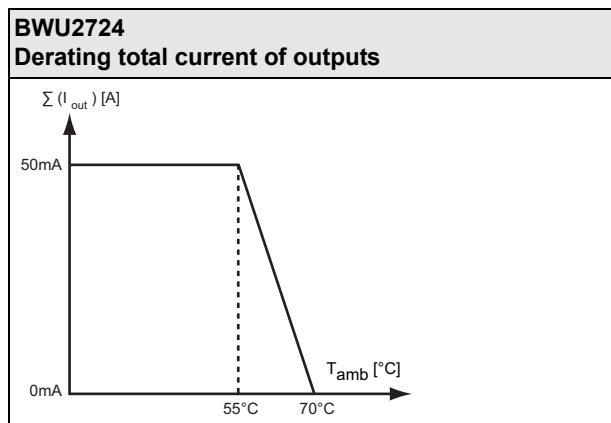

(3) see table "Peripheral fault indication"

(4) temperature range up to -30°C from Ident.No. ≥16285 (BWU2724); Ident.No. ≥16284 (BWU1939).

(5) Maximum ambient operating temperature +55 °C according UL certificate for the use in the USA and Canada.

(6) loop resistance ≤ 150 Ω

(7)

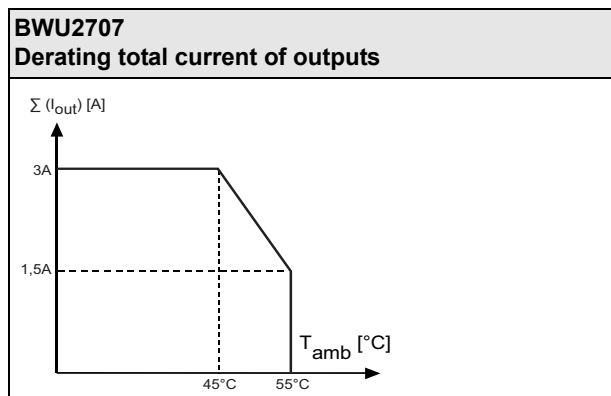

(8)

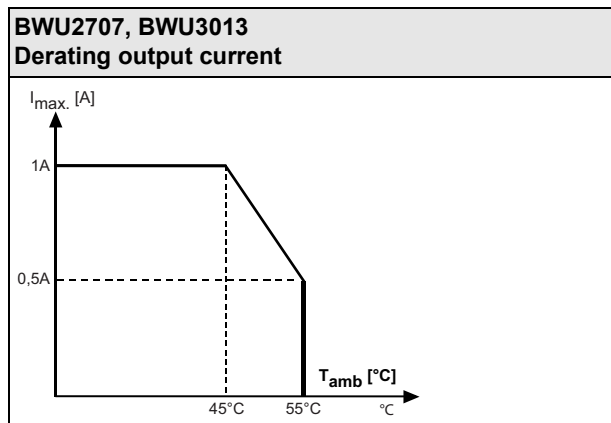

Article no.	BWU2577	BWU2661
Connection		
ASi / AUX Connection	COMBICON plugs, push-in terminals ⁽¹⁾	
Periphery connection	COMBICON plugs, push-in terminals ⁽¹⁾	
Length of connector cable	unlimited ⁽²⁾	I/O: max. 15 m

ASi Safety Input Modules, IP20



Article no.	BWU2577		BWU2661	
ASi				
Profile	S-7.B.1, ID1=F			
Address	1 single slave			
Operating voltage	30 V _{DC} (22 ... 31,6 V)			
Required Master profile	≥M3			
Since ASi specification	2.1			
Max. current input	35 mA			
AUX				
Voltage	24 V _{DC} (20 ... 30 V)			
Max. current input	4 A max.			
Input				
Number	1 x 2-channels safe input			
Safety signal inputs	opto-electronic protective devices	safety mat with 1,2 kΩ or 8,2 kΩ monitoring resistor		
Power supply	out of AUX			
Power supply for external sensors	1,8 A out of AUX		-	
Switching threshold	V _{in} > 11 V for high level, input current ≥ 2,5 mA at 15 V		-	
OSSD input test pulses	0 ... 50 Hz		-	
OSSD input test pulse width	U _{aux} ≥ 21, 5 V= 0 ... 1 ms, test pulses possible U _{aux} ≥ 17 V=0 ... 0,8 ms, test pulses possible U _{aux} < 17 V=0 ... 0,6 ms		-	
Output				
Number	2, electronic, short circuit protected			
Power Supply	out of AUX			
Max. output current	up to 40 °C	1,3 A per output ⁽³⁾		1 A per output ⁽⁶⁾
	at 45 °C	1,0 A per output ⁽³⁾		
	at 55 °C	0,5 A per output ⁽³⁾		0,5 A per output ⁽⁶⁾
Display				
LED ASI (green)	on: ASi voltage on flashing: ASi voltage on, but peripheral fault ⁽⁴⁾ or address 0 off: no ASi voltage			
LED FLT/FAULT (red)	on: no data exchange flashing: peripheral fault ⁽⁴⁾			
LED AUX (green)	-		on: 24 V _{DC} AUX off: no 24 V _{DC} AUX	
LED CC (red)	-		sensor cable break ⁽³⁾	
LEDs O1 ... On (yellow)	state of outputs O1, O2			
LED S1 ... Sn (yellow)	state of inputs S1, S2		state of input S1	

ASi Safety Input Modules, IP20



Article no.	BWU2577	BWU2661
Environment		
Applied standards	EN 60529 EN ISO 13849-2 EN 61000-6-2 EN 61000-6-4 EN 61131-2 EN 62026-2	
	EN 62061 SIL3 EN ISO 13849-1 PLc cat 4	EN 62061 SIL2, EN ISO 13849-1 PLd cat 3
Operating altitude	max. 2000 m	
Ambient temperature	-30°C ... +55 °C ⁽³⁾ ⁽⁵⁾ ⁽⁶⁾	
	no condensation permitted	
Storage temperature	-25 °C ... +85 °C	
Housing	plastic, for DIN rail mounting	
Pollution Degree	2	
Protection category	IP20	
Tolerable loading referring to humidity	according EN 61131-2	
Allowable shock and vibration stress	≤ 15 g, T ≤ 11 ms 10 ... 55 Hz, 0,5 mm amplitude	
Weight	60 g	
Dimensions (W / H / D in mm)	22,5 / 99,6 / 50,5	

(1) see table "Wiring rules"

(2) loop resistance ≤ 150 Ω

(3)

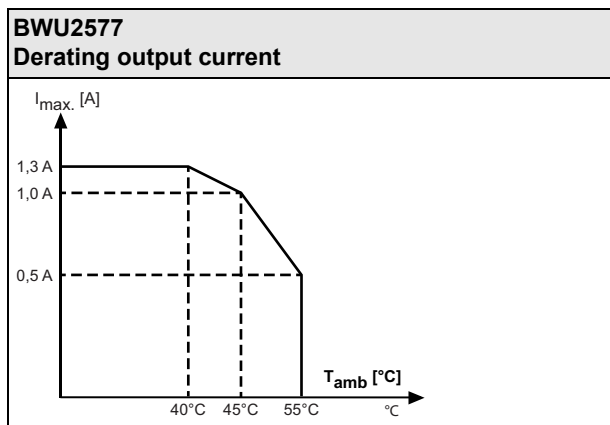

(4) See table "Peripheral fault indication"

(5) Temperature range up to -30°C from Ident.No. ≥16282 (BWU2577).

(6)

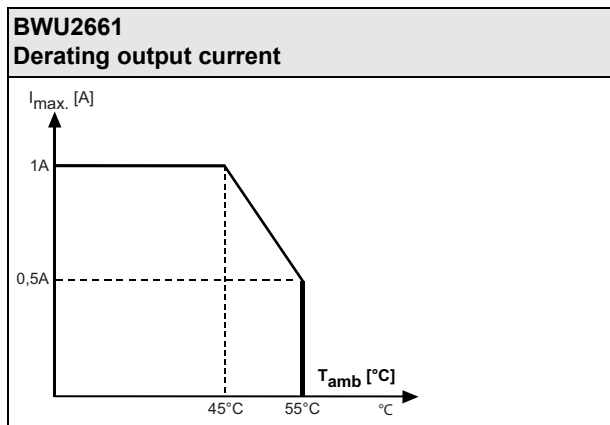

ASi Safety Input Modules, IP20



Article no.	BWU3671		BWU3696
Connection			
ASi / AUX Connection	COMBICON plugs, push-in terminals ⁽¹⁾		
Periphery connection	COMBICON plugs, push-in terminals ⁽¹⁾		
Length of connector cable	unlimited ⁽²⁾		
ASi			
Profile	slave 1: S-7.B.0, ID1=F slave 2: S-7.B.0, ID1=E		
Address	2 single slaves		
Operating voltage	30 V _{DC} (18 ... 31,6 V)		
Required Master profile	≥M3		
Since ASi specification	2.1		
Max. current consumption	60 mA		
Max. current consumption without sensor/ actuator supply	60 mA		
AUX			
Voltage	24 V _{DC} (20 ... 30 V)		
Max. current consumption	max. 1300 mA		
Input			
Number	2 x 2-channels safe inputs		
Safety signal inputs	floating contacts (slave 1) + antivalent opto-electronic protective devices (slave 2)	floating contacts (slave 1) + opto-electronic protective devices (slave 2)	
Switching current	static 4 mA at 24 V, dynamic 15 mA at 24 V (T = 100 µs)		
Power supply	out of AUX		
Power supply for external sensor	up to +30 °C	1200 mA out of AUX ⁽³⁾	
	at +40 °C	1000 mA out of AUX ⁽³⁾	
	at +55 °C	800 mA out of AUX ⁽³⁾	
	at +70 °C	600 mA out of AUX ⁽³⁾	
Switching threshold	for floating contacts: 10 mA, R < 150 Ω for antivalent opto-electronic protective devices: V _{in} > 11 V for high level, input current ≥ 2,5 mA at 15 V	for floating contacts: 10 mA, R < 150 Ω for opto-electronic protective devices: V _{in} > 11 V for high level, input current ≥ 2,5 mA at 15 V	
OSSD input test pulses	0 ... 50 Hz		
OSSD input test pulse width	U _{aux} ≥ 21,5 V = 0 ... 1 ms, test pulses possible U _{aux} ≥ 17 V = 0 ... 0,8 ms, test pulses possible U _{aux} < 17 V = 0 ... 0,6 ms		
Display			
LED ASI /FLT1 (red/green)	green: slave online red: no data exchange yellow/red flashing: address 0 red/green flashing: peripheral error ⁽⁴⁾		
LED ASI /FLT2 (red/green)	green: Slave online red: no data exchange yellow/red flashing: address 0 red/green flashing: peripheral error ⁽⁴⁾ red flashing: slave is switched off because slave 1 addressed 0		
LED AUX (green)	24 V DC AUX on		
LED CC (red)	cross connection ⁽⁴⁾		
LED S1 ... Sn (yellow)	state of inputs S1 ... S4		

ASi Safety Input Modules, IP20

Article no.	BWU3671	BWU3696
Environment		
Applied standards	EN 60529 EN ISO 13849-2 EN 61000-6-2 EN 61000-6-4 EN 61131-2 EN 62026-2	
	EN 62061 SIL3 EN ISO 13849-1 PLe cat 4	
Operating altitude	max. 2000 m	
Ambient temperature	-30 °C ... +55 °C (up to max. +70 °C) ⁽³⁾ ⁽⁵⁾ (no condensation permitted)	
Storage temperature	-25 °C ... +85 °C	
Housing	plastic, for DIN rail mounting	
Pollution Degree	2	
Protection category	IP20	
Tolerable loading referring to humidity	according to EN 61131-2	
Allowable shock and vibration stress	$\leq 15 \text{ g}$, $T \leq 11 \text{ ms}$ 10 ... 55 Hz, 0,5 mm Amplitude	
Weight	160 g	
Dimensions (W / H / D in mm)	22,5 / 99,6 / 114	

(1) see table "Wiring rules"

(2) loop resistance $\leq 150 \Omega$

(3)

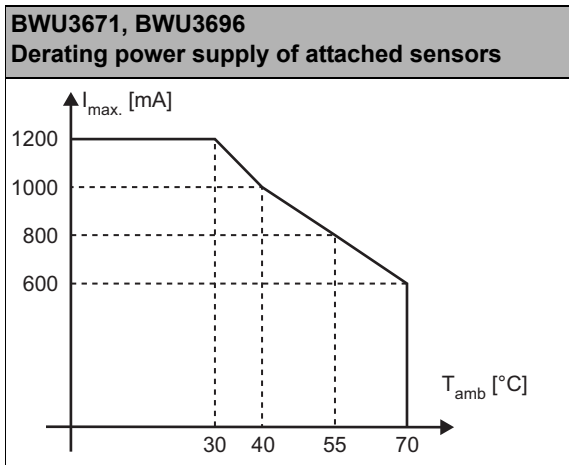

(4) see table "Peripheral fault indication"

(5) Maximum ambient operating temperature +55 °C according UL certificate for the use in the USA and Canada.

ASi Safety Input Modules, IP20



Wiring rules

Push-in terminals	
General	
Nominal cross section	2,5 mm ²
Conductor cross section	
Conductor cross section solid	0,2 ... 2,5 mm ²
Conductor cross section flexible	0,2 ... 2,5 mm ²
Conductor cross section flexible, with ferrule	without plastic sleeve: 0,2 ... 2,5 mm ²
	with plastic sleeve: 0,25 ... 2,5 mm ²
2 conductors with same cross section, stranded, with TWIN ferrules	without plastic sleeve: 0,5 ... 1,5 mm ²
AWG	24 ... 14
Stripped insulation length	10 mm

UL-specifications (UL508)	
BWU1939, BWU2577, BWU2661, BWU2707, BWU2724, BWU2770, BWU2810, BWU3013, BWU3032, BWU3671, BWU3696	
External protection	An isolated source with a secondary open circuit voltage of $\leq 30 V_{DC}$ with a 3 A maximum over current protection. Over current protection is not required when a Class 2 source is employed.
In general	UL mark does not provide UL certification for any functional safety rating or aspects of the above devices.

Article no.	Peripheral fault indication				
	Cross connection	Overload sensor supply	Overload output	AUX voltage missing	Sensor cable break
BWU1939	•	–	–	–	–
BWU2577	–	–	•	•	–
BWU2661	–	–	•	•	•
BWU2707	•	–	–	•	–
BWU2724	•	–	•	–	–
BWU2770	•	–	–	•	–
BWU2810	•	–	•	–	–
BWU3013	•	–	–	•	–
BWU3032	•	–	–	–	–
BWU3671	• (1)	• (2)	–	•	–
BWU3696	• (1)	• (2)	–	•	–

(1) Slave 1 only

(2) Slave 2 only

Programming:	ASi Bit-setting			
	D0	D1	D2	D3
Safe input				
BWU1939 / BWU2724 / BWU3013 / BWU3671 slave 1 / BWU3696 slave 1	S11 / S12		S21 / S22	
BWU2577	S1		S2	
BWU3671 slave 2 / BWU3696 slave 2	S3		S4	
BWU2661	sensor			
BWU2707 slave 1	S11 / S12		S21 / S22	
BWU2707 slave 2	S31 / S32		S41 / S42	
Output				
BWU1939 / BWU2577 / BWU2661 / BWU3013	O1	O2	not used	not used
BWU2707 slave 1 /	O1	O2	not used	not used
BWU2707 slave 2	O3	O4	not used	not used

ASi Safety Input Modules, IP20



	Parameter bit			
	P0	P1	P2	P3
BWU1939 / BWU2577 / BWU2661/ BWU2707 / BWU2724 / BWU3013	0: off/ 1: on (Watchdog)	not used	not used	not used
BWU3671, BWU3696	not used	not used	not used	not used

Connections:

<p>BWU1939</p>	<p>BWU2577</p>
<p>BWU2661</p>	<p>BWU2707</p>
<p>BWU3013</p>	<p>BWU2724</p>

ASi Safety Input Modules, IP20

BWU3671	
Terminals	Description
S22, S21, S12, S11	terminal safety 2-channels input 1 (slave 1) for floating contacts
S4	terminal safety 2-channels input 2 (slave 2) for antivalent OSSD (low active)
S3	terminal safety 2-channels input 2 (slave 2) for antivalent OSSD (high active)
0 V _{ext.out} , 24 V _{ext.out}	power supply for antivalent OSSDs (slave 2)
ASi+, ASi-	connection to the ASi bus
ADDR1	address socket slave 1
ADDR2	address socket slave 2
AUX+ _{ext.in} AUX- _{ext.in}	power supply input

BWU3696	
Terminals	Description
S22, S21, S12, S11	terminal safety 2-channels input 1 (slave 1) for floating contacts
S3, S4	terminal safety 2-channels input 2 (slave 2) for OSSD
0 V _{ext.out} , 24 V _{ext.out}	power supply for OSSDs (slave 2)
ASi+, ASi-	connection to the ASi bus
ADDR1	address socket slave 1
ADDR2	address socket slave 2
AUX+ _{ext.in} AUX- _{ext.in}	power supply input

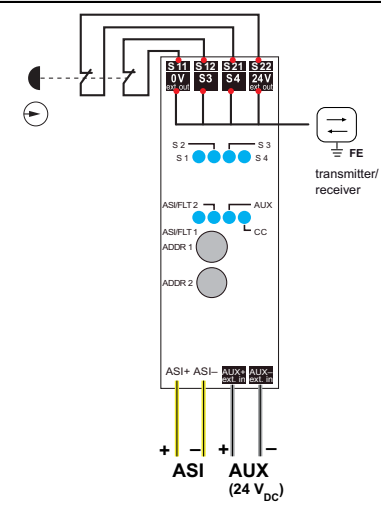
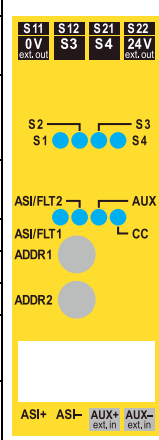



SCATTERGOOD & JOHNSON LTD

ELECTRICAL ENGINEERING & FLUID CONTROL DISTRIBUTORS

Est.1899

At Scattergood & Johnson Ltd, we pride ourselves on being a technical distributor to specialist industries.

Working with a range of quality product suppliers across a number of specialist markets, we are not your average 'box shifter' - we are your technical and supply chain partner.

We fully support every product we sell - for free! Our internal team and external sales engineers can answer any product or application question, no matter the complexity.

Backing up this technical ability is a range of 50,000+ products available from stock for nationwide next day delivery (same day if required!), or you can collect what you need from any of our trade counters around the UK.

Select your specialist interest below to learn more about how we can help.



Online, In Branch and On the Road - Scattergood & Johnson Ltd, there when you need us.

www.scatts.co.uk