

MICRO SWITCH™ Electromechanical Safety Switches

GSS Series

004791

Issue 1

Datasheet



DESCRIPTION

Honeywell's MICRO SWITCH™ GSS Series electromechanical safety switches are comprised of different groups of safety switches designed to either EN50041 or EN50047 standards. GSS Series safety switches are agency certified for global applications, and feature positive opening normally closed contacts . The switch's red body color easily identifies the switch for safety applications. Although these switches are designed for safety applications, they can also be applied in non-safety applications.

The GSA Series metal limit switches are designed to the EN50041 standard with the 30 mm x 60 mm mounting pattern. Available with up to four contacts and a variety of actuator heads, the GSA Series limit switches are suitable for a wide variety of applications.

The GSC Series and GSE Series metal safety switches are designed with an integral hinge lever. The body of the switch is designed to the EN50047 standard with 20 mm to 22 mm mounting. For applications requiring a similar safety switch to the EN50047 standard with a high-strength thermoplastic housing and the integral hinge lever, the GSD Series safety switch can fill the need for this requirement. Where there is limited space on equipment or machinery, the GSC and GSD Series switches with the smaller housing are the preferred solution. As an alternative, the GSC, GSD, and GSE Series can be supplied with the traditional style of side rotary lever or top plunger actuation.

VALUE TO CUSTOMERS

- Operating heads can be rotated in 90° increments for installation flexibility
- All NC contacts (normally closed contacts) are positive opening when actuated
- Removable contact block for ease of wiring

Sensing and Productivity Solutions

FEATURES

- Epoxy coated metal zinc housing (GSA Series, GSC Series, or GSE Series)
- Glass-reinforced thermoplastic housing (GSD Series)
- Red body color for easy safety recognition
- Mounting to EN50041 (GSA Series), or EN50047 (GSC Series, GSD Series, and GSE Series)
- Choice of head/actuator types: pin plunger, roller plunger, side rotary standard lever, side rotary offset lever, top roller lever, or hinge lever
- Wide selection of NC (normally closed) and NO (normally open) contact options
- Different threaded conduit options for global applications
- Environmentally sealed for indoor or outdoor applications
- CE, CSA, and UL agency certifications
- Designed and agency evaluated for safety functions up to and including a SIL3 level (GSA and GSD Hinge Lever)

POTENTIAL APPLICATIONS

- Gates, guards, or doors for:
 - Agricultural and construction equipment
 - Die cast machinery
 - Elevators and moving stairs
 - Machine tools
 - Material handling
 - Packaging machinery
 - Plastic molding machinery
 - Scissor/platform lifts
 - Special purpose machinery

DIFFERENTIATION

- Up to four electrically independent contacts for control and monitoring as required
- Gold contacts available for low energy applications
- Side rotary actuator incorporates dual bearing design for increased life
- Specialty contact option, sequential action (GSA Series)
- Catalog listings designed and evaluated up to and including a safety integrity level 3 (SIL3) per IEC 61508-2:2010 (GSA Series and GSD Hinge Lever Series)

PORTFOLIO

Honeywell offers other non-interlocking safety switches, non-contact safety switches ([FF Series](#)) and cable/rope-pull safety switches ([1CPS & 2CPS Series](#)). Honeywell safety interlocking switches include the metal EN50041 [GK Series](#), metal solenoid [GKL/R Series](#), miniature plastic [GKM Series](#), EN50047 plastic body [GKE Series](#), and plastic body [GKN Series](#).

MICRO SWITCH™ Electromechanical Safety Switches, GSS Series

Table 1. Specifications

Characteristic	Parameter
Description	GSA Safety Switch Series: EN50041 mounting (30 mm x 60 mm) GSC/GSD/GSE Safety Switch Series: EN50047 mounting (20 mm to 22 mm)
Certifications	CE; DOC # 231, EN/IEC 60947-5-1 CSA; File 57323, CSA C22.2 No. 14 UL; File E37138, UL508
Housing material	GSA/GSC/GSE Series; electrostatic epoxy coated die-cast zinc GSD Series; high strength glass-filled thermoplastic
Actuator heads	GSA Series: Side rotary, top pin plunger, top roller plunger, top roller lever GSC/GSD/GSE Series: hinge lever positioned at left, top, or right position
Conduit/electrical connection ¹	0.5-14 NPT; 20 mm; PG 13,5; G1/2 (PF1/2)
Contact/switch options ²	GLA & GLE Series; 1NC/1NO, 2NC, 2NC/2NO, 3NC/1NO, 4NC GLC & GLD Series; 1NC/1NO, 2NC
Contact type	Snap action, snap action sequential (2 step), slow action break-before-make (BBM), slow action make-before-break (MBB), slow action
Contact design	Double break, electrically separated
Contact material	Silver alloy (standard), gold-plated (low energy applications)
Utilization category	AC-15, A300/A600 ³ ; DC-13, Q300
Rated operational voltage (U _e)	240 Vac, 600 Vac, 250 Vdc
Rated operational current (I _e)	3 A, 1.2 A, 0.27 A
Thermal current (I _{th})	10 A
Rated insulation voltage (U _i)	300 V, 600 V
Rated impulse withstand voltage (U _{imp})	2500 V
Short circuit protective device (SCPD)	Class J fuse (10 A/600 V)
Pollution degree	3
Environmental sealing	GSA Series (metal body): IP67, NEMA 1, 4, 12, and 13 GSC & GSE Series (metal body): IP66, NEMA 1, 4, 12, and 13 GSD Series (plastic body): IP66/67, NEMA 1, 4X (indoor), 12, and 13
Operating temperature	GSA Series with side rotary actuator head: -40 °C to 85 °C [-40 °F to 185 °F] GSA Series without side rotary actuator head: -25 °C to 85 °C [-13 °F to 185 °F] GSC/GSD/GSE Series: -25 °C to 85 °C [-13 °F to 185 °F]
Shock	50 G per IEC 60068-2-27
Vibration	10 G per IEC 60068-2-6
MCTF (Mechanical life)	GSA Series: >1,000,000 cycles with single-sided confidence limit of 100% GSD Series (hinge lever actuator): >1,000,000 cycles
MCTF (Electrical life)	GSA Series: >25,000 cycles with single-sided confidence limit of 100% GSD Series (hinge lever actuator): >25,000 cycles with single-sided confidence limit of 100%
SIL capability	GSA & GSD Series (hinge lever actuator); IEC 61508-2:2010; SIL2 capable with HFT=0*; SIL3 capable with HFT=1*
Proof test interval	1 year

¹GSE Series has three (3) threaded conduits.

²All normally closed (NC) contacts are positive opening .

³A600 for GSA Series only. GSA Series with 2NC contacts (06 or 36 switch code) limited to A300.

* Hardware Fault Tolerance (HFT)

MICRO SWITCH™ Electromechanical Safety Switches, GSS Series

Table 2. Electrical Rating

ac				dc				gold-plated contacts
A300/A600**	AC15	VA Rating		Ue	Ie	VA Rating		1 V 10 µA min. 50 V 100 mA max.
Ue	Ie	Make	Break	Volts	Amps	Make	Break	
120	6	7200	720	24	2.8	69	69	
240	3	7200	720	125	0.55	69	69	
380*	1.9	7200	720	250	0.27	69	69	
480*	1.5	7200	720					
500*	1.4	7200	720					
600*	1.2	7200	720					

*GSA Series only. GSA Series with 2NC contacts (06 or 36 switch code) limited to A300.

Figure 1. GSA Safety Switch Application

Two GSA limit switches used to monitor gate position.

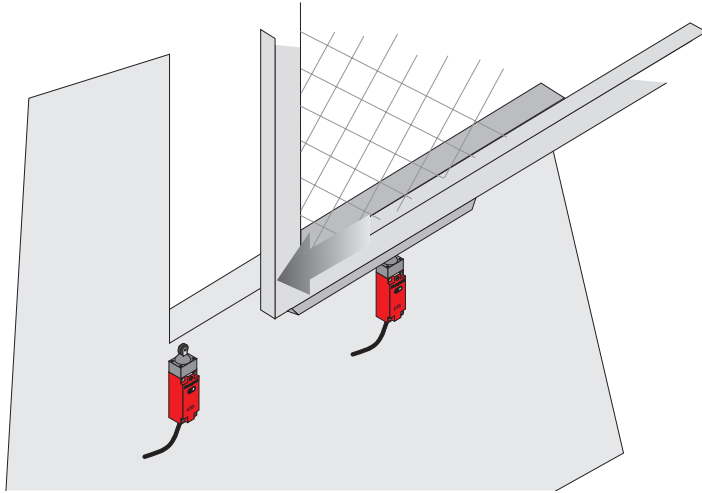
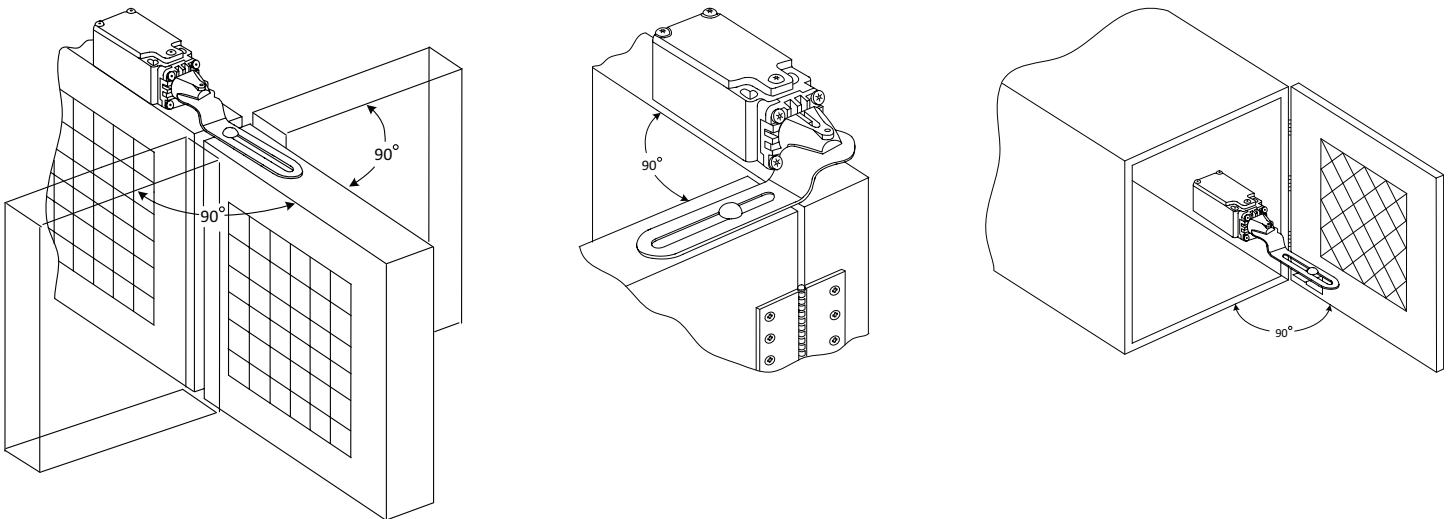

Figure 2. GSS Hinge Safety Switch Application

Hinge-lever safety switches used to monitor gate position.



MICRO SWITCH™ Electromechanical Safety Switches, GSS Series

Figure 3. Product Nomenclature: GSA Series Safety Switch

Switch Type	Conduit	Switch Code		Head/Actuator	Roller Material	Modification Codes
GSA Series Safety Limit Switch	A 1/2-14 NPT	01 SPDT snap action	34 SPDT, MBB slow action gold contacts	A1 Side rotary, fixed length lever	None (blank)	Standard orientation & switching
	B PG 13.5	03 SPDT, BBM slow action	36 2NC slow action, gold contacts	A5 Side rotary, offset lever	A Plastic roller	1 CW rotation only
	C M20 x 1.5	04 SPDT, MBB slow action	40 4NC, slow action	B Top pin plunger	B Metal roller	2 CCW rotation only
	D G 1/2 (PF 1/2)	06 2NC slow action	41 4NC, slow action, gold contacts	C Top roller plunger		3 Lever to right
		07 SPDT, snap action, gold contacts	42 2NC/1NO, BBM slow action	D Top roller lever		4 Lever to left
	20 DPDT, snap action	43 2NC/1NO, BBM slow action, gold contacts	R Top roller ball		5 Lever to mounting surface	
	21 DPDT, snap action, sequential	44 2NC/2NO, BBM slow action			6 Head with roller perpendicular to mtg surface	
	22 DPDT, snap action, gold contacts	45 2NC/2NO, BBM slow action, gold contacts				
	28 DPDT, snap action, sequen. gold contacts	46 3NC/1NO, BBM slow action				
	33 SPDT, BBM slow action gold contacts	47 3NC/1NO, BBM slow action, gold contacts				

Figure 4. Product Nomenclature: GSS Series Hinge Safety Switch

Switch Type	Body Code	Conduit Thread	Switch Code		Actuator Code
GSS Series Hinge Lever Safety Limit Switch	C Zinc die-cast body & head	A 1/2 NPT x 14	GSC, GSD, and GSE		1 Lever to left
			01 SPDT, snap action	40 4NC, BBM slow action	
	D Red thermoplastic body & zinc die-cast head	B PG 13.5	07 SPDT, snap action gold contacts	41 4NC, BBM, slow action, gold contacts	2 Lever to top
			03 SPDT, BBM slow action	42 2NC/1NO, BBM slow action	3 Lever to right
	E Zinc die-cast body & head, 3 conduit	C M20 x 1.5	33 Slow action, BBM, gold contacts	43 2NC/1NO, BBM slow action, gold contacts	4 No lever
			06 2NC slow action	44 2NC/2NO, BBM slow action	
			36 2NC slow action, gold contacts	45 2NC/2NO, BBM slow action, gold contacts	
				46 3NC/1NO, BBM slow action	
				47 3NC/1NO, BBM slow action, gold contacts	





MICRO SWITCH™ Electromechanical Safety Switches, GSS Series

Figure 5. GSS Series Product Circuitry/Switch Code

Available for GSA Switches Only		Available for GSC, GSD, and GSE Switches	Available for GSE Switches Only
01 07	<p>SNAP ACTION SINGLE POLE</p>		
03 33	<p>SLOW ACTION BREAK BEFORE MAKE</p>	<p>01 SNAP-ACTION CONTACTS</p>	<p>40 SLOW-ACTION CONTACTS (BREAK BEFORE MAKE)</p>
04 34	<p>SLOW ACTION MAKE BEFORE BREAK</p>		<p>41 SLOW-ACTION CONTACTS (BREAK BEFORE MAKE) (GOLD PLATED CONTACTS)</p>
06 36	<p>SLOW ACTION 2 NORMALLY CLOSED</p>	<p>03 SLOW-ACTION CONTACTS (BREAK BEFORE MAKE)</p>	
20 22	<p>SNAP ACTION DOUBLE POLE</p>	<p>33 SLOW-ACTION CONTACTS (BREAK BEFORE MAKE) (GOLD PLATED CONTACTS)</p>	<p>42 SLOW-ACTION CONTACTS (BREAK BEFORE MAKE)</p>
21 28	<p>SNAP ACTION DOUBLE POLE</p> <p>STEP 1</p> <p>STEP 2</p>		<p>43 SLOW-ACTION CONTACTS (BREAK BEFORE MAKE) (GOLD PLATED CONTACTS)</p>
40 41	<p>SLOW ACTION 4 NORMALLY CLOSED</p>	<p>06 SLOW-ACTION CONTACTS (2 NORMALLY CLOSED)</p>	
42 43	<p>SLOW ACTION 2 NORMALLY CLOSED/ 1 NORMALLY OPEN BREAK BEFORE MAKE</p>	<p>36 SLOW-ACTION CONTACTS (2 NORMALLY CLOSED) (GOLD PLATED CONTACTS)</p>	<p>44 SLOW-ACTION CONTACTS (BREAK BEFORE MAKE)</p>
44 45	<p>SLOW ACTION 2 NORMALLY CLOSED/ 2 NORMALLY OPEN BREAK BEFORE MAKE</p>	<p>46 SLOW-ACTION CONTACTS (BREAK BEFORE MAKE)</p>	
46 47	<p>SLOW ACTION 3 NORMALLY CLOSED/ 1 NORMALLY OPEN BREAK BEFORE MAKE</p>	<p>47 SLOW-ACTION CONTACTS (BREAK BEFORE MAKE) (GOLD PLATED CONTACTS)</p>	

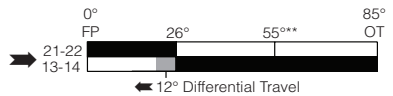
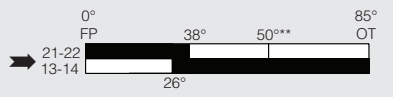
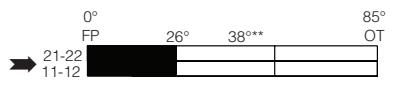
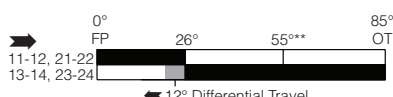
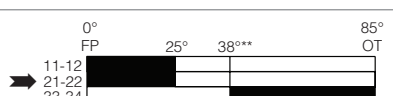
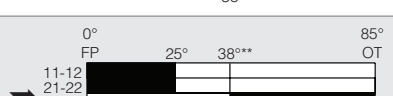
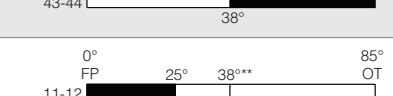
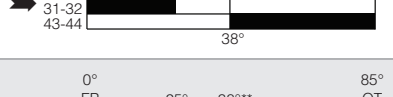
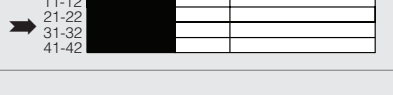
MICRO SWITCH™ Electromechanical Safety Switches, GSS Series

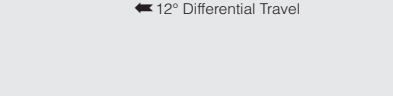
Table 3. GSA Safety Switch (Side Rotary) with 0.5-14NPT Conduit Order Guide

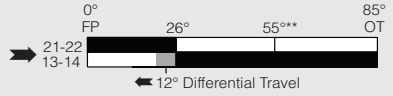





	Catalog Listing 0.5-14 NPT Conduit*	Head and Lever Type	Contacts	Contact Material	Operating Torque max.	Bar Chart (degrees) ■ contact closed □ contact open
	GSAA01A1B	Side rotary with 38,1 mm [1.5 in] lever with steel roller	1NC/1NO snap action	Silver alloy	0,330 Nm [2.9 in-lb]	
	GSAA04A1B	Side rotary with 38,1 mm [1.5 in] lever with steel roller	1NC/1NO slow action, MBB	Silver alloy	0,330 Nm [2.9 in-lb]	
	GSAA06A1B	Side rotary with 38,1 mm [1.5 in] lever with steel roller	2NC slow action	Silver alloy	0,330 Nm [2.9 in-lb]	
	GSAA36A1B	Side rotary with 38,1 mm [1.5 in] lever with steel roller	2NC slow action	Gold plated	0,330 Nm [2.9 in-lb]	
	GSAA20A1B	Side rotary with 38,1 mm [1.5 in] lever with steel roller	2NC/2NO snap action	Silver alloy	0,330 Nm [2.9 in-lb]	
	GSAA22A1B	Side rotary with 38,1 mm [1.5 in] lever with steel roller	2NC/2NO snap action	Gold plated	0,330 Nm [2.9 in-lb]	
	GSAA42A1B	Side rotary with 38,1 mm [1.5 in] lever with steel roller	2NC/1NO slow action, BBM	Silver alloy	0,330 Nm [2.9 in-lb]	
	GSAA44A1B	Side rotary with 38,1 mm [1.5 in] lever with steel roller	2NC/2NO slow action, BBM	Silver alloy	0,330 Nm [2.9 in-lb]	
	GSAA47A1B	Side rotary with 38,1 mm [1.5 in] lever with steel roller	3NC/1NO slow action, BBM	Gold plated	0,330 Nm [2.9 in-lb]	
	GSAA40A1B	Side rotary with 38,1 mm [1.5 in] lever with steel roller	4NC slow action	Silver alloy	0,330 Nm [2.9 in-lb]	
GSAA41A1B	Side rotary with 38,1 mm [1.5 in] lever with steel roller	4NC slow action	Gold plated	0,330 Nm [2.9 in-lb]		
	GSAA01A5B	Side rotary with 38,1 mm [1.5 in] offset lever with steel roller	1NC/1NO snap action	Silver alloy	0,330 Nm [2.9 in-lb]	

*Other conduit options are available, reference Product Nomenclature on page 4.

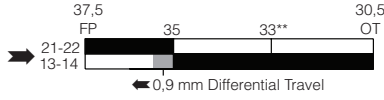
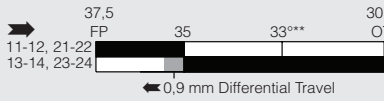
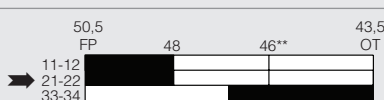
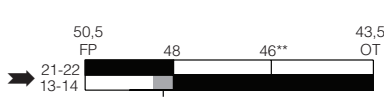
**Positive opening occurs.

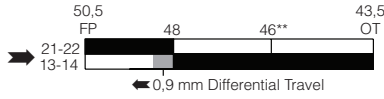
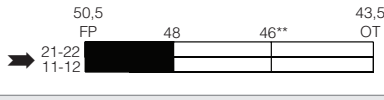
MICRO SWITCH™ Electromechanical Safety Switches, GSS Series

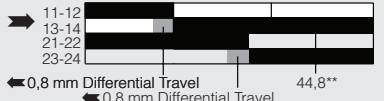
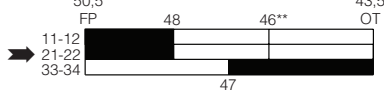
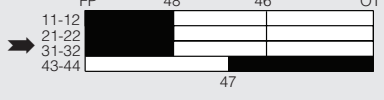
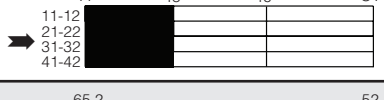
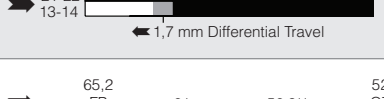
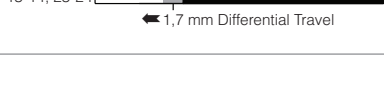
Table 4. GSA Safety Switch (Top Plunger) with 0.5-14NPT Conduit Order Guide

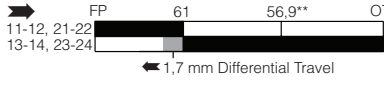







	Catalog Listing 0.5-14 NPT Conduit*	Head and Lever Type	Contacts	Contact Material	Operating Force max.	Bar Chart (mm) ■ contact closed □ contact open
	GSA01B	Top pin plunger	1NC/1NO snap action	Silver alloy	16 N [3.6 lb]	
	GSA020B	Top pin plunger	2NC/2NO snap action	Silver alloy	16 N [3.6 lb]	
	GSA022B	Top pin plunger	2NC/2NO snap action	Gold plated	16 N [3.6 lb]	
	GSA042B	Top pin plunger	2NC/1NO slow action, BBM	Silver alloy	16 N [3.6 lb]	
	GSA01C	Top roller plunger	1NC/1NO snap action	Silver alloy	16 N [3.6 lb]	
	GSA07C	Top roller plunger	1NC/1NO snap action	Gold plated	16 N [3.6 lb]	
	GSA036C	Top roller plunger	2NC slow action	Gold plated	16 N [3.6 lb]	
	GSA020C	Top roller plunger	2NC/2NO snap action	Silver alloy	16 N [3.6 lb]	
	GSA022C	Top roller plunger	2NC/2NO snap action	Gold plated	16 N [3.6 lb]	
	GSA028C	Top roller plunger	2NC/2NO snap action, sequential (2 step)	Gold plated	16 N [3.6 lb]	
	GSA043C	Top roller plunger	2NC/1NO slow action, BBM	Gold plated	16 N [3.6 lb]	
	GSA047C	Top roller plunger	3NC/1NO slow action, BBM	Gold plated	16 N [3.6 lb]	
	GSA040C	Top roller plunger	4NC slow action	Silver alloy	16 N [3.6 lb]	
	GSA01D	Top roller lever	1NC/1NO snap action	Silver alloy	9.5 N [2.1 lb]	
	GSA020D	Top roller lever	2NC/2NO snap action	Silver alloy	9.5 N [2.1 lb]	

*Other conduit options are available, reference Product Nomenclature on page 4.

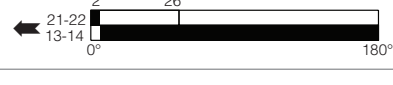
**Positive opening occurs.

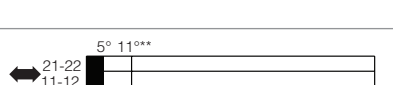
MICRO SWITCH™ Electromechanical Safety Switches, GSS Series

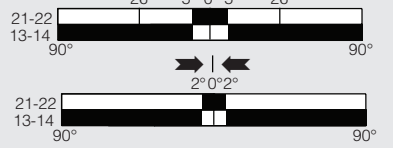
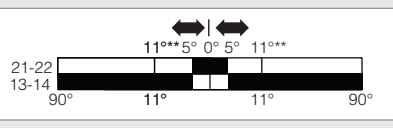
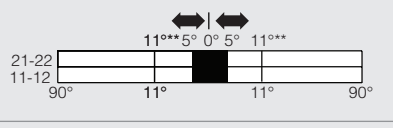
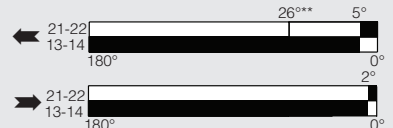
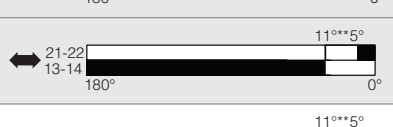
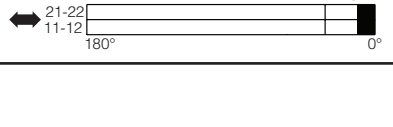
Table 5. GSC, GSD, GSE Safety Switch (Hinge) with 0.5-14NPT Conduit Order Guide

	Catalog Listing with 0.5-14 NPT Conduit*	Hinge Lever Position on Head (safety contacts closed)	Body Material	Contacts	Contact Material	Operating Torque max.	Bar Chart (degrees) ■ contact closed □ contact open
	GSCA01S1	Left	Metal	1NC/1NO snap action	Silver alloy	0,12 Nm [1.1 in-lb]	
	GSCA07S1	Left	Metal	1NC/1NO snap action	Gold plated	0,12 Nm [1.1 in-lb]	
	GSCA03S1	Left	Metal	1NC/1NO slow action, BBM	Silver alloy	0,12 Nm [1.1 in-lb]	
	GSCA33S1	Left	Metal	1NC/1NO slow action, BBM	Gold plated	0,12 Nm [1.1 in-lb]	
	GSCA06S1	Left	Metal	2NC slow action	Silver alloy	0,12 Nm [1.1 in-lb]	
	GSCA01S2	Top	Metal	1NC/1NO snap action	Silver alloy	0,12 Nm [1.1 in-lb]	
	GSCA03S2	Top	Metal	1NC/1NO slow action, BBM	Silver alloy	0,12 Nm [1.1 in-lb]	
	GSCA06S2	Top	Metal	2NC slow action	Silver alloy	0,12 Nm [1.1 in-lb]	
	GSCA36S2	Top	Metal	2NC slow action	Gold plated	0,12 Nm [1.1 in-lb]	
	GSCA01S3	Right	Metal	1NC/1NO snap action	Silver alloy	0,12 Nm [1.1 in-lb]	
	GSCA07S3	Right	Metal	1NC/1NO snap action	Gold plated	0,12 Nm [1.1 in-lb]	
	GSCA03S3	Right	Metal	1NC/1NO slow action, BBM	Silver alloy	0,12 Nm [1.1 in-lb]	
GSCA06S3	Right	Metal	2NC slow action	Silver alloy	0,12 Nm [1.1 in-lb]		

*Other conduit options are available, reference Product Nomenclature on page 4.

** Positive opening occurs.

MICRO SWITCH™ Electromechanical Safety Switches, GSS Series

Table 5. GSC, GSD, GSE Safety Switch (Hinge) with 0.5-14NPT Conduit Order Guide, continued





	Catalog Listing with 0.5-14 NPT Conduit*	Hinge Lever Position on Head (safety contacts closed)	Body Material	Contacts	Contact Material	Operating Torque max.	Bar Chart (degrees) ■ contact closed □ contact open
	GSDA01S1	Left	Plastic	1NC/1NO snap action	Silver alloy	0,12 Nm [1.1 in-lb]	
	GSDA03S1	Left	Plastic	1NC/1NO slow action, BBM	Silver alloy	0,12 Nm [1.1 in-lb]	
	GSDA06S1	Left	Plastic	2NC slow action	Silver alloy	0,12 Nm [1.1 in-lb]	
	GSDA01S2	Top	Plastic	1NC/1NO snap action	Silver alloy	0,12 Nm [1.1 in-lb]	
	GSDA03S2	Top	Plastic	1NC/1NO slow action, BBM	Silver alloy	0,12 Nm [1.1 in-lb]	
	GSDA06S2	Top	Plastic	2NC slow action	Silver alloy	0,12 Nm [1.1 in-lb]	
	GSDA01S3	Right	Plastic	1NC/1NO snap action	Silver alloy	0,12 Nm [1.1 in-lb]	
	GSDA03S3	Right	Plastic	1NC/1NO slow action, BBM	Silver alloy	0,12 Nm [1.1 in-lb]	
	GSDA06S3	Right	Plastic	2NC slow action	Silver alloy	0,12 Nm [1.1 in-lb]	

*Other conduit options are available, reference Product Nomenclature on page 4.

** Positive opening occurs.

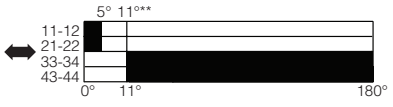
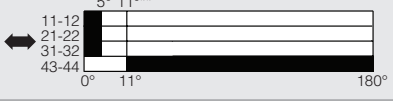
MICRO SWITCH™ Electromechanical Safety Switches, GSS Series

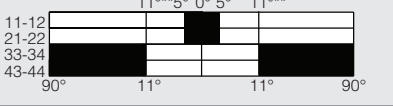
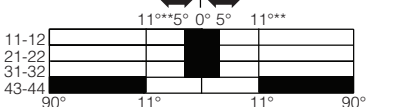
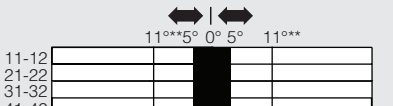
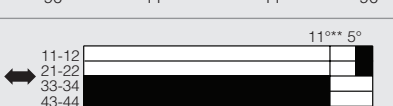
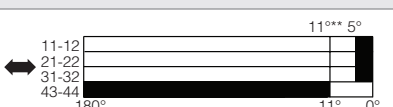
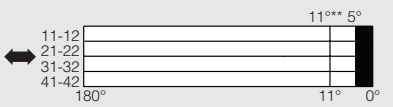
Table 5. GSC, GSD, GSE Safety Switch (Hinge) with 0.5-14NPT Conduit Order Guide, continued

	Catalog Listing with 0.5-14 NPT Conduit*	Hinge Lever Position on Head (safety contacts closed)	Body Material	Contacts	Contact Material	Operating Torque max.	Bar Chart (degrees) ■ contact closed □ contact open
Three Conduits 	GSEA44S1	Left	Metal	2NC/2NO slow action, BBM	Silver alloy	0,12 Nm [1.1 in-lb]	
	GSEA46S1	Left	Metal	3NC/1NO slow action, BBM	Silver alloy	0,12 Nm [1.1 in-lb]	
	GSEA41S1	Left	Metal	4NC slow action	Gold-plated	0,12 Nm [1.1 in-lb]	
	GSEA44S2	Top	Metal	2NC/2NO slow action, BBM	Silver alloy	0,12 Nm [1.1 in-lb]	
	GSEA46S2	Top	Metal	3NC/1NO slow action, BBM	Silver alloy	0,12 Nm [1.1 in-lb]	
	GSEA40S2	Top	Metal	4NC slow action	Silver alloy	0,12 Nm [1.1 in-lb]	
	GSEA41S2	Top	Metal	4NC slow action	Gold-plated	0,12 Nm [1.1 in-lb]	
	GSEA44S3	Right	Metal	2NC/2NO slow action, BBM	Silver alloy	0,12 Nm [1.1 in-lb]	
	GSEA46S3	Right	Metal	3NC/1NO slow action, BBM	Silver alloy	0,12 Nm [1.1 in-lb]	
	GSEA41S3	Right	Metal	4NC slow action	Gold-plated	0,12 Nm [1.1 in-lb]	

*Other conduit options are available, reference Product Nomenclature on page 4.

** Positive opening occurs.

MICRO SWITCH™ Electromechanical Safety Switches, GSS Series

Figure 4. GSA Side Rotary (Head Code A1) Dimensions

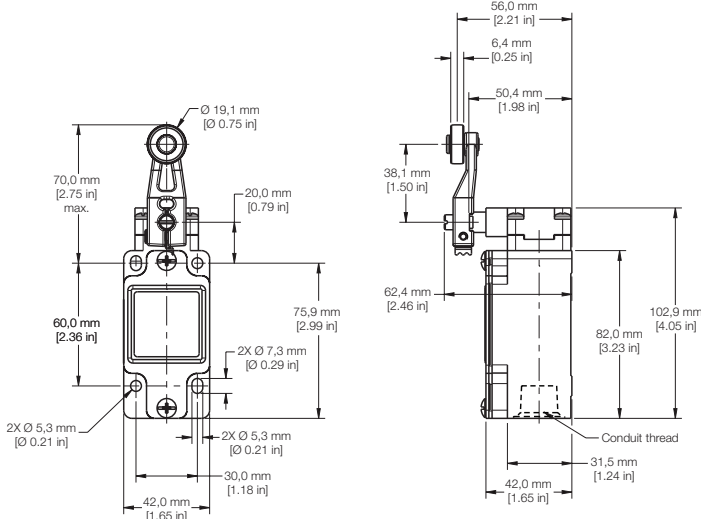

Figure 5. GSA Side Rotary (Head Code A5) Dimensions

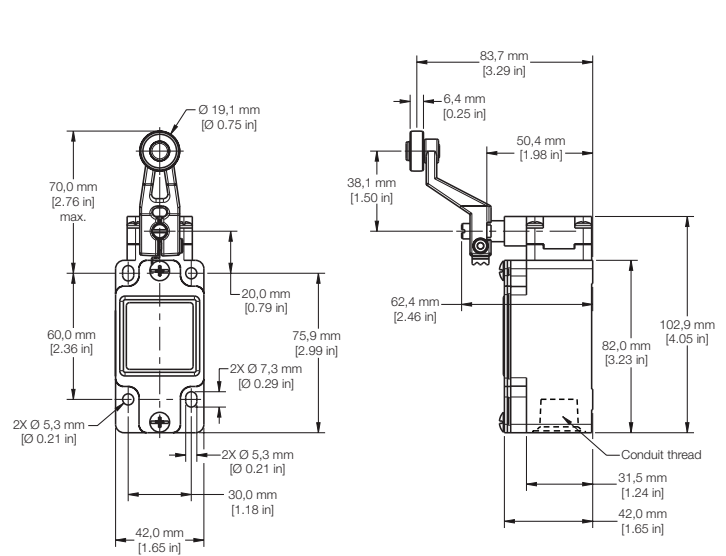

Figure 6. GSA Pin Plunger (Head Code B) Dimensions

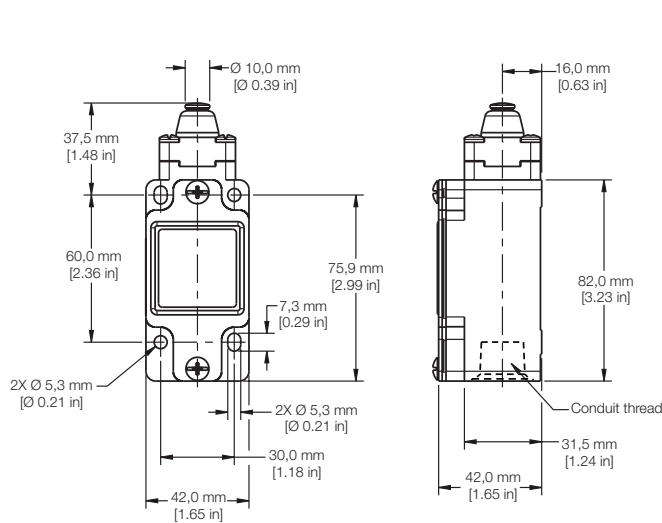

Figure 7. GSA Roller Plunger (Head Code C) Dimensions

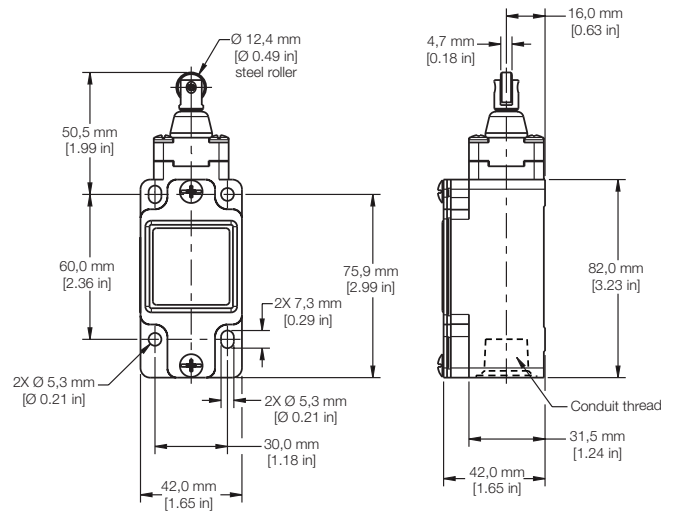

Figure 8. GSA Roller Arm (Head Code D) Dimensions

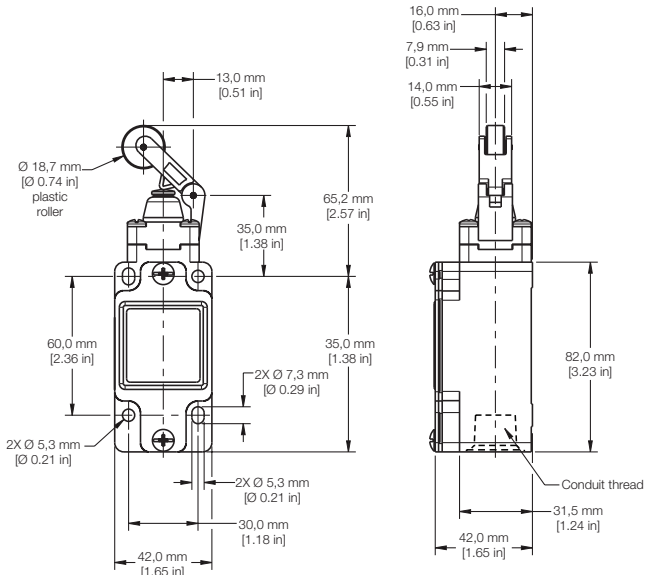
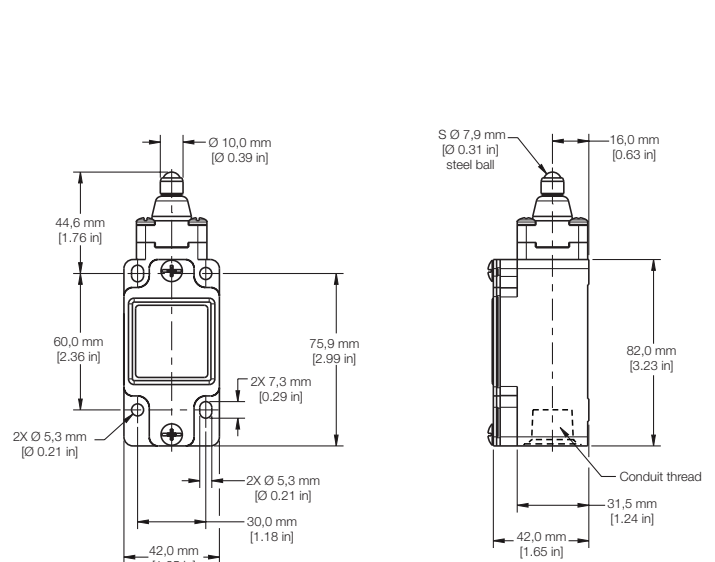
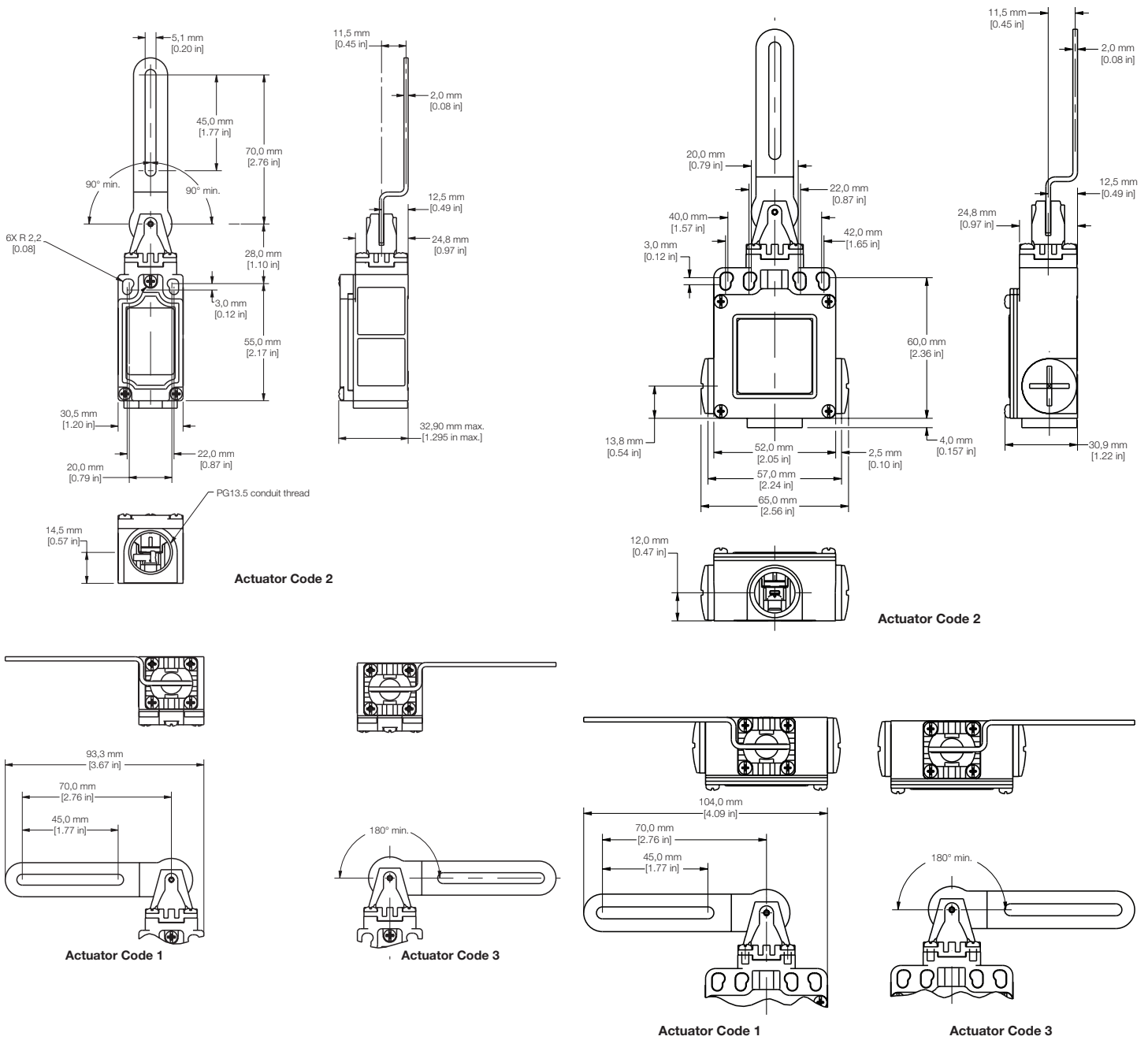

Figure 9. GSA Pin Plunger (Head Code R) Dimensions



MICRO SWITCH™ Electromechanical Safety Switches, GSS Series

Figure 10. GSC/GSD Series with Hinge Overall Dimensions mm [in] Figure 11. GSE Series with Hinge Overall Dimensions mm [in]



ADDITIONAL MATERIALS

The following associated literature is available on the Honeywell web site at sensing.honeywell.com:

- Product installation instructions
- Product range guide
- Product line guide

Find out more

Honeywell serves its customers through a worldwide network of sales offices, representatives and distributors. For application assistance, current specifications, pricing or name of the nearest Authorized Distributor, contact your local sales office. To learn more about Honeywell's sensing and switching products, call **+1-815-235-6847** or **1-800-537-6945**, visit sensing.honeywell.com, or e-mail inquiries to info.sc@honeywell.com

Honeywell Sensing and Productivity Solutions

9680 Old Bailes Road
Fort Mill, SC 29707
honeywell.com

004791-1-EN IL50 GLO
March 2016
© 2016 Honeywell International Inc. All rights reserved.

⚠ WARNING **RISK TO LIFE OR PROPERTY**

Never use this product for an application involving serious risk to life or property without ensuring that the system as a whole has been designed to address the risks, and that this product is properly rated and installed for the intended use within the overall system.

Failure to comply with these instructions could result in death or serious injury.

⚠ WARNING **MISUSE OF DOCUMENTATION**

- The information presented in this product sheet is for reference only. Do not use this document as a product installation guide.
- Complete installation, operation, and maintenance information is provided in the instructions supplied with each product.

Failure to comply with these instructions could result in death or serious injury.

Warranty/Remedy

Honeywell warrants goods of its manufacture as being free of defective materials and faulty workmanship. Honeywell's standard product warranty applies unless agreed to otherwise by Honeywell in writing; please refer to your order acknowledgement or consult your local sales office for specific warranty details. If warranted goods are returned to Honeywell during the period of coverage, Honeywell will repair or replace, at its option, without charge those items it finds defective. **The foregoing is buyer's sole remedy and is in lieu of all other warranties, expressed or implied, including those of merchantability and fitness for a particular purpose. In no event shall Honeywell be liable for consequential, special, or indirect damages.**

While we provide application assistance personally, through our literature and the Honeywell web site, it is up to the customer to determine the suitability of the product in the application.

Specifications may change without notice. The information we supply is believed to be accurate and reliable as of this printing. However, we assume no responsibility for its use.

Honeywell



SCATTERGOOD & JOHNSON LTD

ELECTRICAL ENGINEERING & FLUID CONTROL DISTRIBUTORS

Est.1899

At Scattergood & Johnson Ltd, we pride ourselves on being a technical distributor to specialist industries.

Working with a range of quality product suppliers across a number of specialist markets, we are not your average 'box shifter' - we are your technical and supply chain partner.

We fully support every product we sell - for free! Our internal team and external sales engineers can answer any product or application question, no matter the complexity.

Backing up this technical ability is a range of 50,000+ products available from stock for nationwide next day delivery (same day if required!), or you can collect what you need from any of our trade counters around the UK.

Select your specialist interest below to learn more about how we can help.



Online, In Branch and On the Road - Scattergood & Johnson Ltd, there when you need us.

www.scatts.co.uk