

# 2.16

## Fixing systems for installing luminaires

### Complete systems and single components

The one-off manufacture of individual assembly systems for installing lighting systems is often very costly. The patented Complete Assembly System is a low-cost, standard fixing system for light fittings on industrial rails, walls or steel beam constructions.

#### Stability and material

A specially developed shaping method that ensures a high degree of stability is used for this programme. Stainless steel with optimised material

strength is used in environments with aggressive media. Components that are not made of stainless steel are hot-dip galvanised after manufacture in accordance with DIN EN ISO 1461.

#### Assembly

The assembly systems have been designed for inside and outside areas. The compact system kits can be assembled by just one person in a very short time. All individual parts are simply fitted together and fas-

tened by screws. Since there is no need for drilling or welding, it is possible to work in hazardous areas without a „hot work permit“.

#### Safety

The assembly system is always installed from the safe side of the work platform, i.e. without scaffolding! The specified hand-rail height and the avoidance of protruding metal parts or screws in the construction provides a high standard of safety.

#### Cost-saving maintenance

The use of tilting luminaire masts results in decisive cost advantages due to minimised maintenance. Thus, for example, changing a lamp without scaffolding or assembly aids is possible for just one person in a very short time. The costs for cleaning and repair work can also be minimised.



#### Features

- Easy to install
- Corrosion protected (stainless steel or hot-dip galvanized)
- Extra solid construction ensures high wind load resistance

## Ordering details

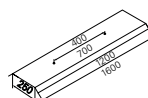









Type	OU	Order No.
<b>Pole-system bent 90°</b>		
Light pole, 90° bend and drilling hole f. LTR 48 and LTRS 48: type LM 48 - 2300/300 - FT, hot-dip galvanized	1	<b>2 2480 520 001</b>
Light pole 90° bend and drilling hole f. LTR 48 and LTRS 48: type LM 48 - 1900/300 - FT, hot-dip galvanized	1	<b>2 2480 520 002</b>
Light fitting support pipe with cable outlet: type LTR 48 - 600 - FT, hot-dip galvanized	1	<b>2 2480 530 001</b>
Light fitting support pipe with cable outlet: type LTR 48 - 1200 - FT, hot-dip galvanized	1	<b>2 2480 530 002</b>
Light fitting support pipe with cable outlet: type LTR 48 - 1500 - FT, hot-dip galvanized	1	<b>2 2480 530 003</b>
Light fitting support pipe clamp 90° twisted: type LTRS 48 - FT, hot-dip galvanized	1	<b>2 2480 550 012</b>
<b>Pole-system bent 45°</b>		
Light pole, 45° bend, for pole-mounting light fittings: type LMZ 48 - 1900/190 - FT, hot-dip galvanized	1	<b>2 2480 520 006</b>
Light pole, 45° bend, , e.g. for floodlights: type LM 48 - 1900/190 - FT, hot-dip galvanized	1	<b>2 2480 520 007</b>
Light pole whip form, 45° bend: type LMP 48 - 1900/1300 - FT, hot-dip galvanized	1	<b>2 2480 520 003</b>
Light pole whip form, 45° bend: type LMP 48 - 2100/1300 - FT, hot-dip galvanized	1	<b>2 2480 520 004</b>
Light pole whip form, 45° bend: type LMP 48 - 2100/800 - FT, hot-dip galvanized	1	<b>2 2480 520 005</b>
Wall-mounted light pole whip form, 45° bend, with cable outlet: type LMW 48 - 500/1300 - FT, hot-dip galvanized	1	<b>2 2480 520 008</b>
Wall-mounted light pole whip form, 45° bend, with cable outlet: type LMW 48 - 500/800 - FT, hot-dip galvanized	1	<b>2 2480 520 009</b>
Light pole fixture for wall mounting, set 2 pcs.: type LMHW 48 - FT, hot-dip galvanized	1	<b>2 2480 550 001</b>
<b>Light pole clamp</b>		
Light pole clamp, fixed, UMHS 48/48 - FT, hot-dip galvanized	1	<b>2 2480 550 002</b>
Light pole clamp, fixed, with pole slip protection UMHSD 48/48 - FT, hot-dip galvanized	1	<b>2 2480 550 003</b>
Light pole clamp, swivel, with pole slip protection, UMHK 48/48 - ER, stainless steel	1	<b>2 2480 550 004</b>
Light pole clamp, fixed, UMHS 48/48 - ER, stainless steel	1	<b>2 2480 550 005</b>
Light pole clamp, fixed, with pole slip protection UMHSD 48/48 - ER, stainless steel	1	<b>2 2480 550 006</b>
Light pole clamp, swivel, with pole slip protection, UMHK 48/48 - FT, hot-dip galvanized	1	<b>2 2480 550 007</b>
<b>End caps for poles and pipes</b>		
End cap with cable outlet Ø 15 mm: type SEL 48 - K, plastic	1	<b>2 2480 550 015</b>
End cap closed: type SEG 48 - K, plastic	1	<b>2 2480 550 016</b>
End cap open: type SEO 48 - K, plastic	1	<b>2 2480 550 115</b>
<b>Canopy for fluorescent light fittings</b>		
Canopy for fluorescent light fittings 18 W LSD 1200 - ER 1200 mm length, hole spacing: 400 mm	1	<b>2 2480 540 001</b>
Canopy for fluorescent light fittings 18 W LSD 1600 - ER 1600 mm length, hole spacing: 700 mm	1	<b>2 2480 540 002</b>

## 2.16

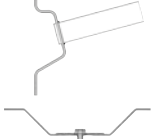

## Ordering details

Fixing systems / Accessories/LED Modules/Lamps

## Ordering details

Type		OU	Order No.
<b>Pipe clamps</b>			
	2 pcs. pipe clamps R12 (1 1/4"), Ø 38 - 42 mm with screws and polyamide washer, hot-dip galvanized	1	2 2480 462 000
	2 pcs. pipe clamps R14 (1 1/4"), Ø 38 - 42 mm with screws and polyamide washer, stainless steel	1	2 2480 464 000
	2 pcs. pipe clamps R22 (1 1/2"), Ø 47 - 51 mm with screws and polyamide washer, hot-dip galvanized	1	2 2480 472 000
	2 pcs. pipe clamps R24 (1 1/2"), Ø 47 - 51 mm with screws and polyamide washer, stainless steel	1	2 2480 474 000
	2 pcs. pipe clamps R32 (2"), Ø 56 - 60 mm with screws and polyamide washer, hot-dip galvanized	1	2 2480 482 000
	2 pcs. pipe clamps R34 (2"), Ø 56 - 60 mm with screws and polyamide washer, stainless steel	1	2 2480 484 000
	1 pcs. pipe clamp A8 (1 1/2") D 47 - 51 mm for AB 12.. with screws and polyamide washer, hot-dip galvanized	1	NOR 000 005 009 211
	1 pcs. pipe clamp A9 (2") D 56 - 60 mm for AB 12.. with screws and polyamide washer, hot-dip galvanized	1	NOR 000 005 009 229
	2 pcs. pipe clamp, two-part, for pipe mounting LB 48 - FT with screws and polyamide washer, hot-dip galvanized	1	2 2480 550 010
<b>Fixing accessories</b>			
	2 pcs. luminaire mounting bracket with 30° angle, wall mounting LH 30 - FT, hot-dip galvanized	1	2 2480 550 013
	2 pcs. luminaire mounting bracket with 45° angle, wall mounting LH 45 - FT, hot-dip galvanized	1	2 2480 550 014
	2 pcs. wall mounting bracket with 30° angle, with screws and polyamide washer, hot-dip galvanized	1	2 2480 000 122
	1 pcs. wall bracket 45° with screws and polyamide washer, hot-dip galvanized	1	NOR 000 005 009 196
	1 pcs. wall bracket W 27, 15°, for pole-mounting fitting Ø 42 mm, hot-dip galvanized	1	2 2483 027 000
	2 pcs. ceiling mounting bracket D 92 with screws and polyamide washer, stainless steel	1	2 2480 092 000
	1 pcs. ceiling mounting bracket A5 with screws and polyamide washer, hot-dip galvanized	1	NOR 000 005 009 162
	2 pcs. C-bracket for luminaire mounting LAB-C50 - ER, stainless steel	1	2 2480 550 011
	2 pcs. hexagon screw M8 x 20 for luminaire mounting, with polyamide washer	1	2 2480 054 000
	2 pcs. eye bolt M8 for luminaire mounting, hot-dip galvanized	1	2 2480 002 000
	2 pcs. eye bolt M8 for luminaire mounting, stainless steel	1	2 2480 004 000
	1 pcs. eye bolt M8 - A1 for luminaire mounting, hot-dip galvanized	1	NOR 000 005 009 261
	Hexagon box spanner SW 13 for opening/closing fluorescent light fittings eLLK/M and nLLK/M	1	3 2485 000 005

## LED-Modules / Lamps

Type	Application	Order No. 4000 K	Order No. 5600 K	
	LED module 400	for eLLK 92 018/18 incl. conversion kit	1 2255 213 501	1 2255 213 511
	LED module 800	for eLLK 92 036/36 incl. conversion kit	1 2256 226 501	1 2256 226 511
	LED module 400	for eLLK 92 018/18 LED Ready	1 2255 213 101	1 2255 213 111
	LED module 800	for eLLK 92 036/36 LED Ready	1 2256 226 101	1 2256 226 111
Type	Application	Order No.		
	Fluorescent lamp G13 T8/Ø 26 mm 18 W 840 - 1350 lm	3 2475 900 001		
	Fluorescent lamp G13 T8/Ø 26 mm 36 W 840 - 3350 lm	3 2475 900 002		
	Fluorescent lamp G13 T8/Ø 26 mm 58 W 840 - 5200 lm	3 2475 900 003		
	Fluorescent lamp G13 T8 18 W Ultimate 840	3 2475 900 087		
	Fluorescent lamp G13 T8 36 W Ultimate 840	3 2475 900 088		
	Fluorescent lamp G13 T8 58 W Ultimate 840	3 2475 900 089		

Light pole 90° bended

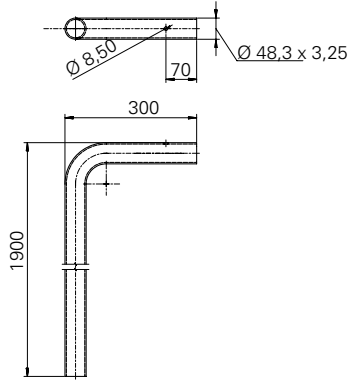

Light fitting support pipe with cable outlet

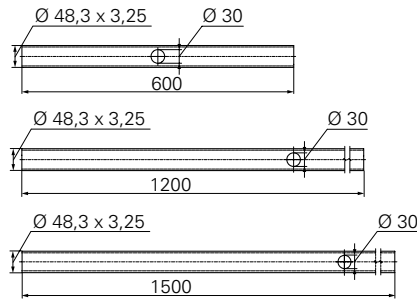

Light fitting support pipe clamp 90° twisted:

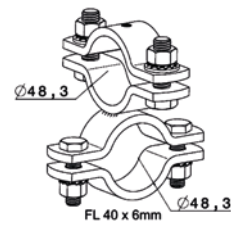

LMZ 48 - 1900/190 - FT

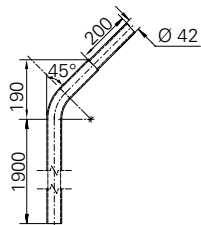

LM 48 - 1900/190 - FT

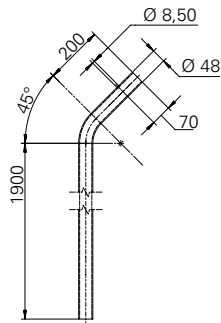

LMW 48 - 500/800 - FT

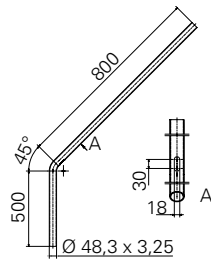

LMW 48 - 500/1300 - FT

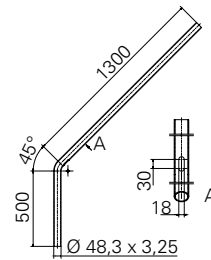

LMP 48 - 1900/1300 - FT/  
LMP 48 - 2100/1300 - FT/  
LMP 48 - 2100/800 - FT

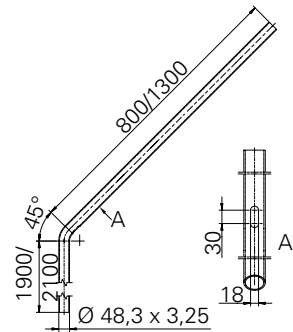

LMHW 48 - FT

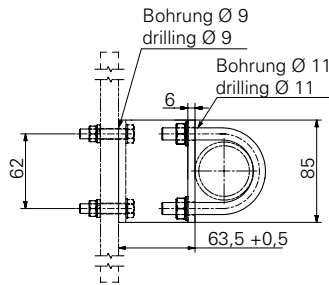

UMHS 48/48 - FT/ER - UMHSD 48/48 - FT/ER

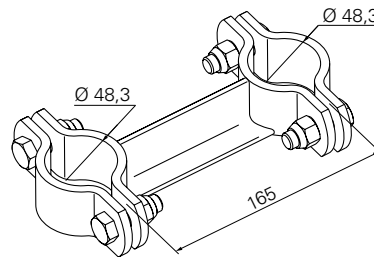

UMHK 48/48 - ER / FT

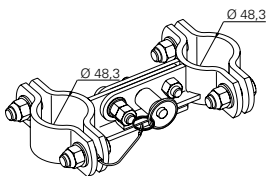

End cap SEL 48 / SEG / SEO

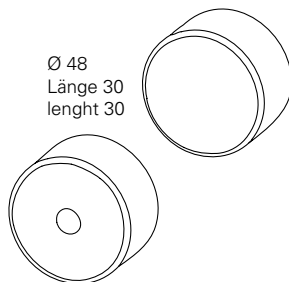

LSD 1200 - ER/ LSD 1600 - ER

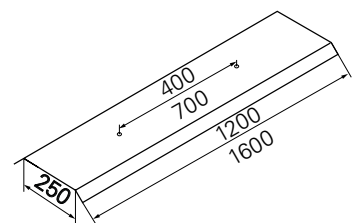

Dimensions in mm

# 2.16

## Dimension drawing

Fixing systems / Accessories

**Pipe clamp**

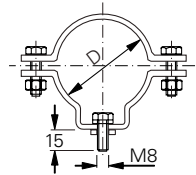

Type	D
R12/R14	38-42 mm
R22/R24/A8	47-51 mm
R32/R34/A9	56-60 mm

**Pipe clamp LB 48 - FT**

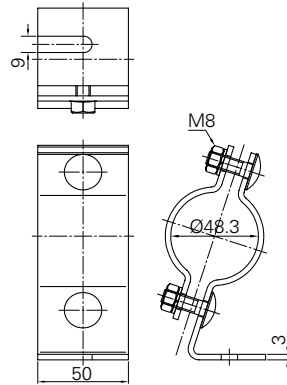

**Leuchtenmontagebügel 30°  
LH 30 - FT**

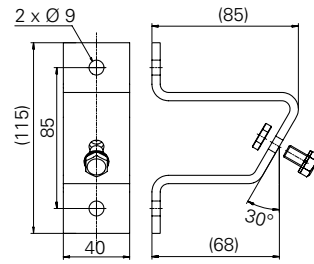

**45°  
LH 45 - FT**

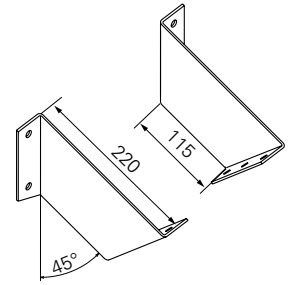

**Wandarm W27**

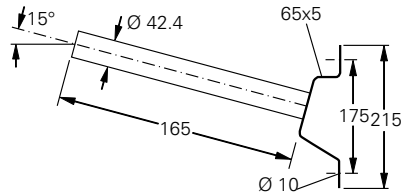

**Ceiling bracket D92**

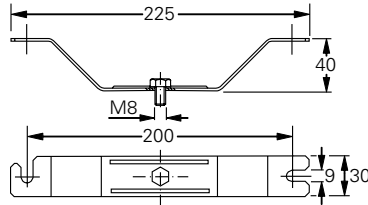

**C-bracket**

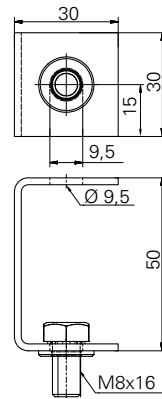

**Eye bolt**

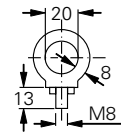

**Wandbügel 45°**

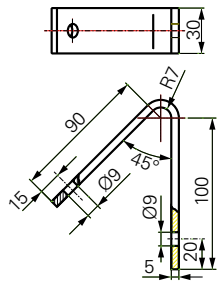

**Ceiling bracket A5**

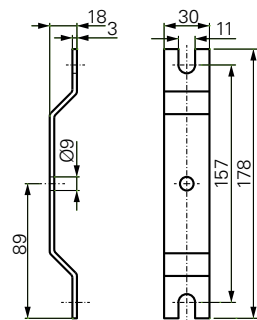

Dimensions in mm



# SCATTERGOOD & JOHNSON LTD

ELECTRICAL ENGINEERING & FLUID CONTROL DISTRIBUTORS

Est.1899

At Scattergood & Johnson Ltd, we pride ourselves on being a technical distributor to specialist industries.

Working with a range of quality product suppliers across a number of specialist markets, we are not your average 'box shifter' - we are your technical and supply chain partner.

We fully support every product we sell - for free! Our internal team and external sales engineers can answer any product or application question, no matter the complexity.

Backing up this technical ability is a range of 50,000+ products available from stock for nationwide next day delivery (same day if required!), or you can collect what you need from any of our trade counters around the UK.

Select your specialist interest below to learn more about how we can help.



Online, In Branch and On the Road - Scattergood & Johnson Ltd, there when you need us.

# [www.scatts.co.uk](http://www.scatts.co.uk)