

GEMS SENSORS & CONTROLS

OPERATING & INSTALLATION INSTRUCTIONS

INTRINSICALLY SAFE SERIES 3XIS

Part Number: 560550-0123

Issue: C



PLEASE READ THESE INSTRUCTIONS CAREFULLY BEFORE INSTALLING AND STARTING THE PRESSURE TRANSDUCER. KEEP INSTRUCTIONS ACCESSIBLE TO ALL USERS AT ALL TIMES

For all customer enquiries, contact:-



01256 320244



www.gemssensors.com



sales@gems-sensors.com



Customer Services, Gems Sensors & Controls, Lennox Road, Basingstoke, Hants, RG22 4AW.

INTRODUCTION

This product is a pressure transducer which provides linear electrical output proportional to applied pressure and is intended for use for pressure measurement in Hazardous Area (IIB).

Intrinsically-safe transducers with 2 or 3 pin outputs or a 3-wire screened cable 'conduit' version are available with pressure output only. See Pin out table CONNECTION INFORMATION section for details.

The transducer is suitable for use in areas exposed to dust, subject to the stipulated conduit connections where applicable.

CERTIFICATION

Certification is by ATEX Certificate Number Baseefa10ATEX0196 and IECEx Certificate Number IECEx BAS 13.0079. This indicates a Safety Classification of  II 1G Ex ia IIB T4 Ga ($-40^{\circ}\text{C} \leq T_a \leq +80^{\circ}\text{C}$).

The 3XIS series is certified Intrinsically Safe for use in Group IIB Hazardous Areas, Zones 0, 1 and 2 when used in conjunction with a Zener safety barrier or Galvanic Isolation barrier.

Conformity with the requirements of the Approval Certificate only applies when the installation conditions described in these instructions have been met.

Input Parameters:

$$U_i = 30\text{V}$$

$$I_i = 100\text{mA}$$

$$P_i = 0.7\text{W}$$

$$C_i = 353\text{nF}$$

$$L_i = 209\mu\text{H}$$

These parameters include the capacitance and inductance associated with up to 100m of cable.

HAZARDOUS PRODUCTS

The Consumer Protection Act of 1987, Section 6 of the Health and Safety at Work Act 1974 and the Control of Substances Hazardous to Health Regulations 1988 require that we advise recipients and users of our products of any potential hazards associated with their storage, handling or use.

The products which our Company supplies may be classified as Electrical, Electro-Mechanical and Electronic equipment.

These products are tested and supplied in accordance with our published specifications or individual special requirements that are agreed in writing at time of order. They are constructed so as not to affect adversely the safety of persons and property when properly installed, maintained and used by qualified personnel, in the applications for which they were designed and manufactured

GENERAL

The equipment is designed and manufactured to:

- avoid physical injury or other harm which may be caused by direct or indirect contact.
- ensure that excess surface temperature of accessible parts or radiation which would cause a danger are not produced.
- eliminate non-electrical dangers which are revealed by experience.
- ensure that foreseeable conditions of overload will not give rise to dangerous situations.

Provided that:

- * Pressure range must be compatible with the maximum pressure being measured.
- * Pressure media must be compatible with the transducer/transmitter wetted parts listed in these instructions.
- * Liquid must not be allowed to freeze in the pressure port.
- * The gasket must be fitted under the electrical connector.

Please check according to label details below:

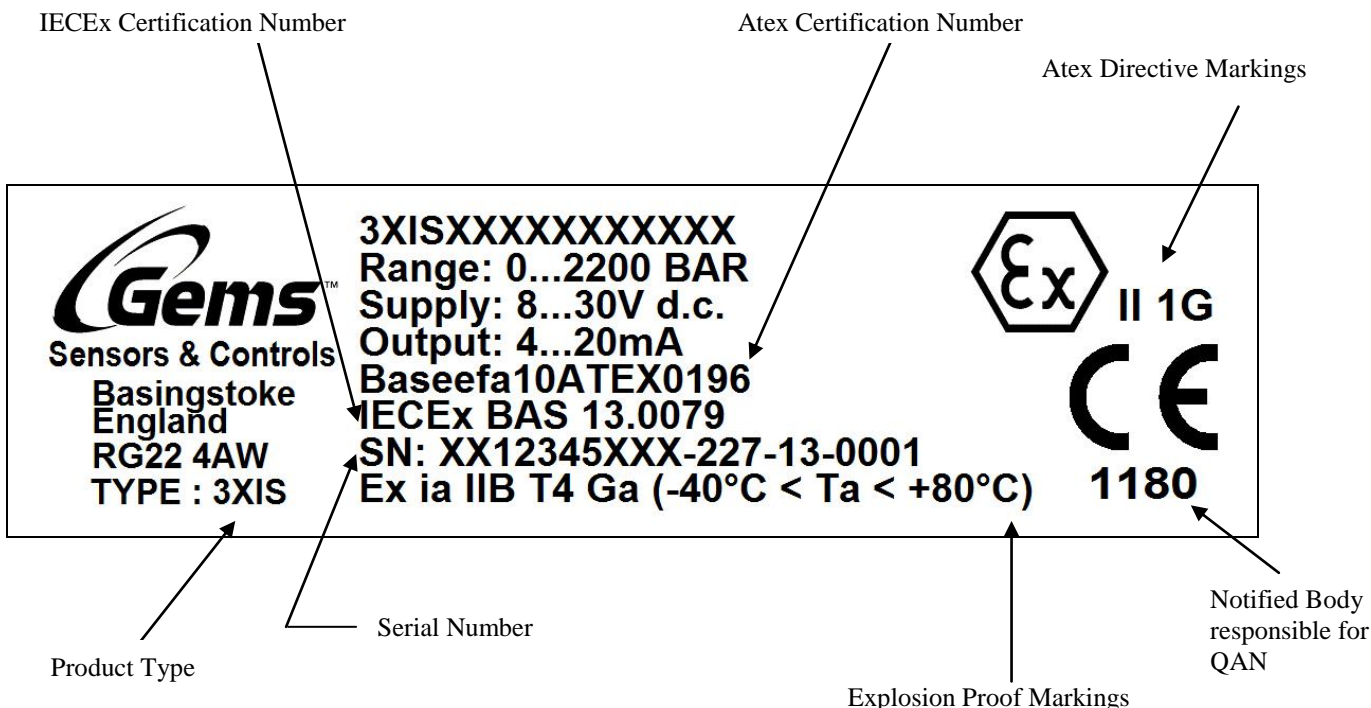

INSTALLATION & START UP

Install and start up the transducer ONLY if it is in a faultless condition. Screw or unscrew the transducer using the hexagon flats ONLY and observing the prescribed torque, do NOT use the electrical connector case for screwing or unscrewing!

Tools required for Installation:

Transducer Mounting:	Wrench 22mm or 27mm depending on product
Industry Standard form C Connector:	Screwdriver

Cables: Where applicable, ensure cable selected is suitable to fit the electrical connector cable gland. On installation of cables and cable glands, ensure all seals are correctly fitted and that cable positioning does not impair ingress protection of seals.

For transducers supplied with integrated cable, minimum bend radius is 75mm.

‘O’ Rings: Transducers are not shipped with soft seals. Process connections which require a soft seal (‘O’ ring) are the responsibility of the installer. They must be suitable for both application temperature and relevant media.

VOLTAGE APPLICATIONS

The following schematic is applicable for any voltage output – only pull-down configuration shown. External load (R_{L1}) is optional and can be connected between Voutput1 and EITHER supply rail. With “0V offsets”, pull-up resistors cannot be used.

Application Schematic (Example):

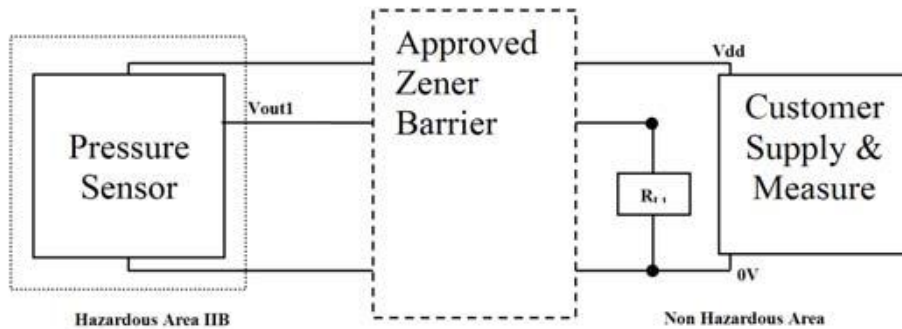

Absolute Output Mode: (Typical output ranges are 0-10V, 0-5V, 1-6V and 1-5V)

Parameter	Min	Typ	Max	Units	Comments
Supply Voltage (Vdd) (4)	8		30	V	Measured at the input to the transducer terminals. For higher operating voltages consult factory
Supply Head-Room to Vout1 Output	1			V	Example: 0-10V doable from 11V supply. This is only valid with no external leads

Note (4): Supply voltage to product must be limited by appropriate zener barrier as a requirement under I.S.

Ratiometric Output Mode: (Typical output ranges are 0.5-4.5V(r) and 0.25-4.75V(r))
Various Optional failure diagnostics exist – consult factory:

Parameter	Min	Typ	Max	Units	Comments
Supply Voltage (Vdd)	4.5	5	5.5	V	

General Voltage Output Modes: (Additional Voltage Mode Specification)

Parameter	Min	Typ	Max	Units	Comments
Operating Current Draw		3.5	5.5	mA	With no external loads
Output Impedance	-10%	80	+10%	W	
External Load (sink/source current)			2	mA	Any external output load must not sink or source more than 2mA. Consult factory for further limitations

CURRENT APPLICATIONS

The external loop load (R_L) is optional with within limits specified below and includes all connection/harness resistances. Load can be placed in either supply line.

Application Schematic (Example):

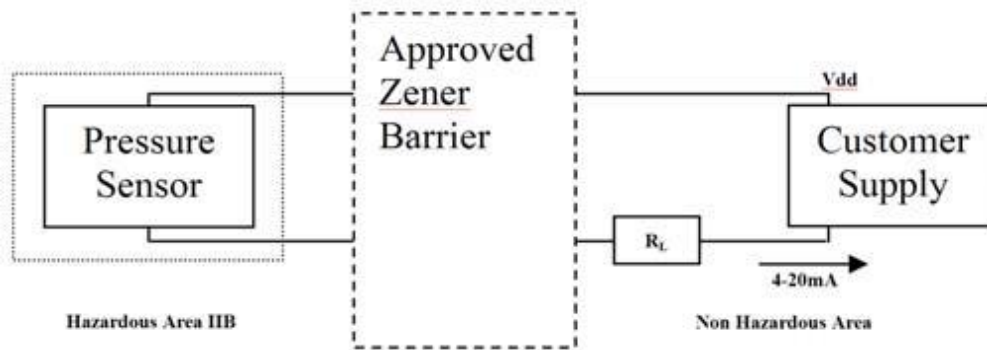

Current Output Mode: (Typical output is 4-20mA)

Parameter	Min	Typ	Max	Units	Comments
Supply Voltage (Vdd) (5)	8		30	V	Measured at the input to the transducer terminals. Customer supply can be greater depending on load used – see graph and summary below.
Pressure Output Current	4		20	mA	Current loop will limit between 25-28mA for protection on overpressure, supply dependent.

Note (5): Supply voltage to product must be limited by appropriate zener barrier as a requirement under I.S.

R_L Load Limitations for Current Output Mode:

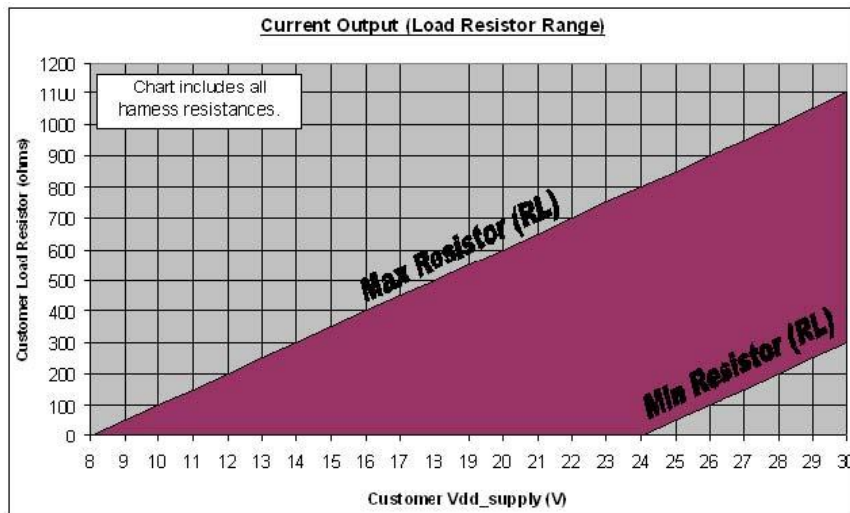

Min Resistor (RL) = 50 * (Vdd_supply - 24) : for Vdd >24V

Max Resistor (RL) = 50 * (Vdd_supply - 8) : for Vdd >8V

SERVICING

The transducer is not to be repaired by the user and must be replaced by an equivalent certified unit. Repairs should only be carried out by the manufacturer or an approved repairer.

RETURN TO FACTORY

PLEASE NOTE: To comply with Health and Safety requirements, the instrument must be clean and safe to handle and accompanied by a formal statement to that effect duly signed by an authorised officer of the Company.

Any instrument returned without certification will be quarantined and no action will occur until cleared. It may ultimately be returned to you and subject to a transportation charge.

MAINTENANCE

Routine Inspection: Not required except for periodic inspection of the cable and connector to ensure that these are neither damaged nor softened by incompatible liquid

STORAGE & DISPOSAL

When storing or disposing of transducer, take precautions with remaining media – it may be hazardous or toxic. Refit thread protection cap during storage periods.

Dispose of transducer and packaging materials in accordance with local waste treatment disposal regulations of the country or region to which the instrument is supplied.

CONNECTION INFORMATION (Please see the available Connector & Pin Assignments below:

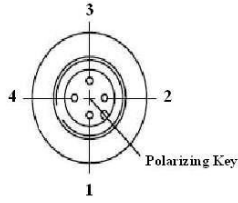
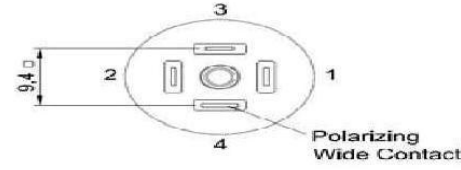
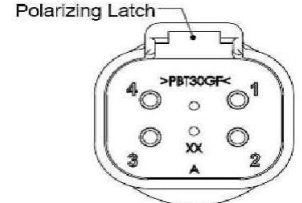
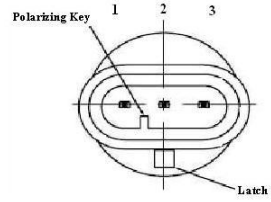
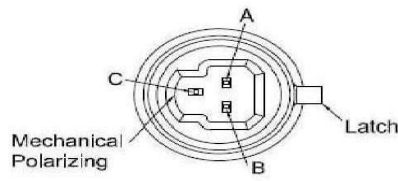
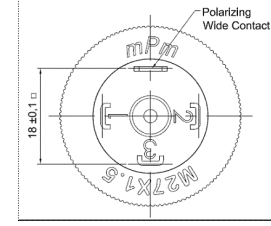
<p>M12:</p>  <table border="1" style="margin-top: 10px; width: 100%; border-collapse: collapse;"> <thead> <tr> <th>Pin</th> <th>Voltage</th> <th>Current</th> </tr> </thead> <tbody> <tr> <td>1</td> <td>+IN</td> <td>+IN</td> </tr> <tr> <td>2</td> <td>+OP</td> <td>DNC</td> </tr> <tr> <td>3</td> <td>0V</td> <td>0V</td> </tr> <tr> <td>4</td> <td>NC</td> <td>NC</td> </tr> </tbody> </table>	Pin	Voltage	Current	1	+IN	+IN	2	+OP	DNC	3	0V	0V	4	NC	NC	<p>INDUSTRY STANDARD FORM C:</p>  <table border="1" style="margin-top: 10px; width: 100%; border-collapse: collapse;"> <thead> <tr> <th>Pin</th> <th>Voltage</th> <th>Current</th> </tr> </thead> <tbody> <tr> <td>1</td> <td>+IN</td> <td>+IN</td> </tr> <tr> <td>2</td> <td>0V</td> <td>0V</td> </tr> <tr> <td>3</td> <td>+OP</td> <td>DNC</td> </tr> <tr> <td>4</td> <td>NC</td> <td>NC</td> </tr> </tbody> </table>	Pin	Voltage	Current	1	+IN	+IN	2	0V	0V	3	+OP	DNC	4	NC	NC
Pin	Voltage	Current																													
1	+IN	+IN																													
2	+OP	DNC																													
3	0V	0V																													
4	NC	NC																													
Pin	Voltage	Current																													
1	+IN	+IN																													
2	0V	0V																													
3	+OP	DNC																													
4	NC	NC																													
<p>DEUTSCH DT04-4P:</p>  <table border="1" style="margin-top: 10px; width: 100%; border-collapse: collapse;"> <thead> <tr> <th>Pin</th> <th>Voltage</th> <th>Current</th> </tr> </thead> <tbody> <tr> <td>1</td> <td>0V</td> <td>0V</td> </tr> <tr> <td>2</td> <td>+IN</td> <td>+IN</td> </tr> <tr> <td>3</td> <td>NC</td> <td>NC</td> </tr> <tr> <td>4</td> <td>+OP</td> <td>DNC</td> </tr> </tbody> </table>	Pin	Voltage	Current	1	0V	0V	2	+IN	+IN	3	NC	NC	4	+OP	DNC	<p>AMP SUPERSEAL 1.5 SERIES:</p>  <table border="1" style="margin-top: 10px; width: 100%; border-collapse: collapse;"> <thead> <tr> <th>Pin</th> <th>Voltage</th> <th>Current</th> </tr> </thead> <tbody> <tr> <td>1</td> <td>+OP</td> <td>DNC</td> </tr> <tr> <td>2</td> <td>0V</td> <td>0V</td> </tr> <tr> <td>3</td> <td>+IN</td> <td>+IN</td> </tr> </tbody> </table>	Pin	Voltage	Current	1	+OP	DNC	2	0V	0V	3	+IN	+IN			
Pin	Voltage	Current																													
1	0V	0V																													
2	+IN	+IN																													
3	NC	NC																													
4	+OP	DNC																													
Pin	Voltage	Current																													
1	+OP	DNC																													
2	0V	0V																													
3	+IN	+IN																													
<p>METRIPACK T (150 SERIES):</p>  <table border="1" style="margin-top: 10px; width: 100%; border-collapse: collapse;"> <thead> <tr> <th>Pin</th> <th>Voltage</th> <th>Current</th> </tr> </thead> <tbody> <tr> <td>A</td> <td>0V</td> <td>0V</td> </tr> <tr> <td>B</td> <td>+IN</td> <td>+IN</td> </tr> <tr> <td>C</td> <td>+OP</td> <td>DNC</td> </tr> </tbody> </table>	Pin	Voltage	Current	A	0V	0V	B	+IN	+IN	C	+OP	DNC	<p>DIN 43650A:</p>  <table border="1" style="margin-top: 10px; width: 100%; border-collapse: collapse;"> <thead> <tr> <th>Pin</th> <th>Voltage</th> <th>Current</th> </tr> </thead> <tbody> <tr> <td>1</td> <td>+IN</td> <td>+IN</td> </tr> <tr> <td>2</td> <td>0V</td> <td>0V</td> </tr> <tr> <td>3</td> <td>+OP</td> <td>DNC</td> </tr> <tr> <td>4</td> <td>NC</td> <td>NC</td> </tr> </tbody> </table>	Pin	Voltage	Current	1	+IN	+IN	2	0V	0V	3	+OP	DNC	4	NC	NC			
Pin	Voltage	Current																													
A	0V	0V																													
B	+IN	+IN																													
C	+OP	DNC																													
Pin	Voltage	Current																													
1	+IN	+IN																													
2	0V	0V																													
3	+OP	DNC																													
4	NC	NC																													
<p>INTEGRATED CABLE:</p> <table border="1" style="margin-top: 10px; width: 100%; border-collapse: collapse;"> <thead> <tr> <th>Colour</th> <th>Voltage</th> <th>Current</th> </tr> </thead> <tbody> <tr> <td>RED</td> <td>+IN</td> <td>+IN</td> </tr> <tr> <td>BLACK</td> <td>0V</td> <td>0V</td> </tr> <tr> <td>WHITE</td> <td>+OP</td> <td></td> </tr> </tbody> </table>	Colour	Voltage	Current	RED	+IN	+IN	BLACK	0V	0V	WHITE	+OP		<p>NOTES:</p> <p>DNC: Do Not Connect (Leave Floating)</p> <p>NC: Not Connected at Transducer End</p>																		
Colour	Voltage	Current																													
RED	+IN	+IN																													
BLACK	0V	0V																													
WHITE	+OP																														



EC DECLARATION OF CONFORMITY

Manufacturers Name: Gems Sensors & Controls
Manufacturers Address: Lennox Road, Basingstoke, Hants, RG22 4AW
Product Type: 3XIS
Description: Intrinsically Safe Industrial Pressure Transducers
Date of Issue: 7th November 2011

Gems Sensors & Controls hereby declares that the product above conforms with the essential protection requirements of the following EC Directives:

PED: *Equipment marked CE0086 complies with the requirements of the Pressure Equipment Directive 97/23/EC and is classed as a safety accessory and can be used as a safety-related device on Category IV pressure equipment. Conformity assessment procedure followed is to Modules B+D. Module B EC Type examination certificate number CE72108 issued by BSI 0086 Mayland Avenue, Hemel Hempstead, Herts, HP2 4SQ, England. The notified body monitoring the quality assurance system is BSI 0086 Mayland Avenue, Hemel Hempstead, Herts, HP2 4SQ, England. The Technical Specifications used are Gems Sensors Design Standards.*

SAFETY: *“For the equipment within which this component is installed to comply with the Low Voltage Directive 2006/95/EC, this product must be powered from a Safety Extra Low Voltage (SELV) source of 42V peak maximum.*

When the power source is derived from a transformer this must conform to EN 60742 or equivalent, with intrinsic short circuit protection. The power source to this component must also incorporate suitable over-current protection related to the current rating of this component”

ATEX: *Equipment marked with the certificate number 10ATEX0196 and also marked Ex ia IIB T4 Ga complies with the requirements of the EU Directive 94/9/EC Equipment by compliance with the Essential Health & Safety Requirements of Harmonised Standard EN 60079-0 : 2009 and EN 60079-11 : 2007*

Notified Body for EC-Type Examination & Production
 Baseefa 1180
 Buxton, UK

This apparatus must not be put into service until the equipment into which it is to be incorporated has been declared in conformity with the provisions of the relevant New Approach Directive.

Signed for and on behalf of
 Gems Sensors & Controls
 Mark Fania
 VP Operations Europe &
 Basingstoke Site Leader
 England

563947 Issue B



SCATTERGOOD & JOHNSON LTD

ELECTRICAL ENGINEERING & FLUID CONTROL DISTRIBUTORS

Est.1899

At Scattergood & Johnson Ltd, we pride ourselves on being a technical distributor to specialist industries.

Working with a range of quality product suppliers across a number of specialist markets, we are not your average 'box shifter' - we are your technical and supply chain partner.

We fully support every product we sell - for free! Our internal team and external sales engineers can answer any product or application question, no matter the complexity.

Backing up this technical ability is a range of 50,000+ products available from stock for nationwide next day delivery (same day if required!), or you can collect what you need from any of our trade counters around the UK.

Select your specialist interest below to learn more about how we can help.



Online, In Branch and On the Road - Scattergood & Johnson Ltd, there when you need us.

www.scatts.co.uk