

FS-380 Series – Compact Flow Switch for High Inline Pressures

Flow Rate Settings: 0.15 GPM to 2.00 GPM
Port Size: Multiple
Primary Construction Material: Brass or Stainless Steel
Setting Type: Fixed

These rugged inline flow switches require 100 micron filtration and are less susceptible to clogging than other high-pressure inline flow switches. The one-piece magnetic PPS composite piston makes the FS-380 ideal for high-pressure applications such as industrial cleaning equipment. The FS-380 is also an excellent choice for semicon cooling applications where simple design and reliable operation are required.

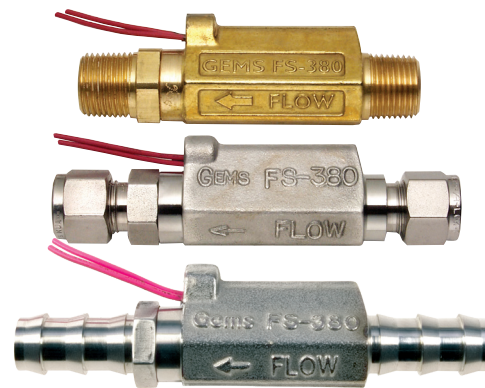

Specifications

Wetted Materials	
Housing	Brass or 316 Stainless Steel
Piston	PPS Composite, Epoxy
Spring	316 Stainless Steel
O-Ring	Fluorocarbon
Operating Pressure, Maximum	1500 PSI (107 bar); 500 PSI (34 bar) for 1/2" Barb Models
Operating Temperature	-20°F to +275°F (-28.8°C to +135°C)
Set Point Accuracy	±20% Maximum
Set Point Differential	20% Maximum
Switch*	SPST, 20VA, N.O. at no Flow
Electrical Termination	No. 22 AWG, 24" to 26" Polymeric leads

*See "Electrical Data" on Page X-5 for more information.

Spacing

To prevent sensor to sensor magnetic field interference, follow the spacing guidelines below.

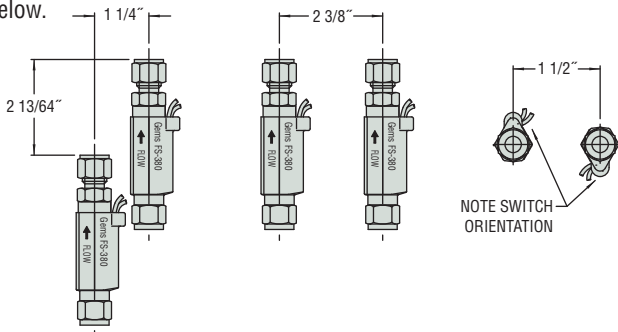

How To Order – Standard Models

Specify Part Number based on flow settings.

Flow Settings GPM ¹	Brass		Stainless Steel			
	1/2" NPT Male	3/8" NPT Male	3/8" NPT Male	1/4" Compression	3/8" Compression	1/2" Barb
0.15	—	181130 ⚡	193482 ⚡	259118	212136	239693
0.25	192562 ⚡	168432 ⚡	179992 ⚡	259119	177592 ⚡	239692
0.50	192563	168433 ⚡	179993 ⚡	259121	177593	239691
1.00	192564 ⚡	168434 ⚡	179994 ⚡	259122	177594 ⚡	239690
1.50	192566	168435	179995 ⚡	—	177595 ⚡	239689
2.00	192567	178353 ⚡	179996	—	225525	239688

⚡ – Stock Items.

Note:
 1. Flow settings are calibrated using water @ 70°F on increasing flow with units in horizontal position. Consult factory for other fluid compatibility.

Dimensions

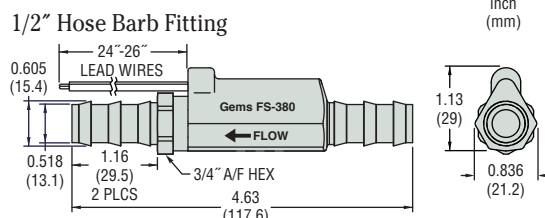

1/4" and 3/8" Tube End Compression Fitting

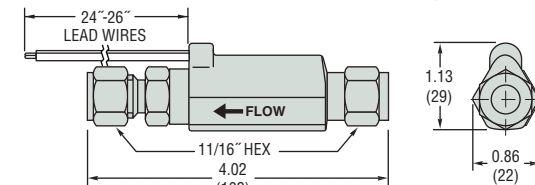

1/2" NPT Ports

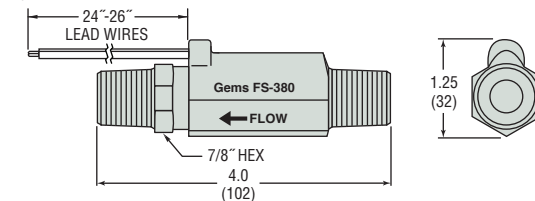

3/8" NPT Ports

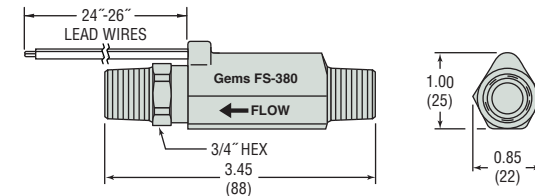

Pressure Drop – Typical

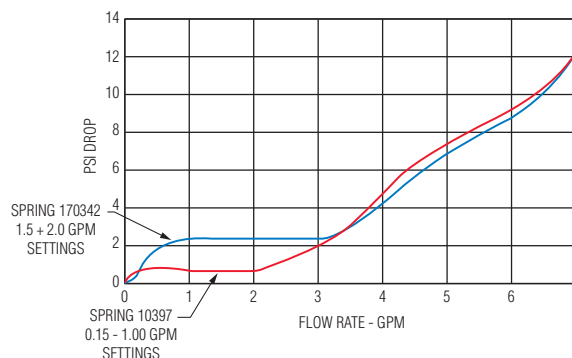



SCATTERGOOD & JOHNSON LTD

ELECTRICAL ENGINEERING & FLUID CONTROL DISTRIBUTORS

Est.1899

At Scattergood & Johnson Ltd, we pride ourselves on being a technical distributor to specialist industries.

Working with a range of quality product suppliers across a number of specialist markets, we are not your average 'box shifter' - we are your technical and supply chain partner.

We fully support every product we sell - for free! Our internal team and external sales engineers can answer any product or application question, no matter the complexity.

Backing up this technical ability is a range of 50,000+ products available from stock for nationwide next day delivery (same day if required!), or you can collect what you need from any of our trade counters around the UK.

Select your specialist interest below to learn more about how we can help.



Online, In Branch and On the Road - Scattergood & Johnson Ltd, there when you need us.

www.scatts.co.uk