

EBONY MOULDED CASE CURRENT TRANSFORMERS

TE'S CROMPTON INSTRUMENTS

Ebony moulded case current transformers

FEATURES

- CT ratios from 1A to 6000A with 5A and 1A secondaries
- Accuracy up to class 0.5
- Integral terminal cover
- High impact, flame retardant moulded case
- Busbar, DIN-rail or foot mounting options



* Thermal current (I_{th}) & dynamic current (I_{dyn})

I_{th} is the highest primary current (effective value), the I_{dyn} is the highest primary current (Peak Value) that the CT can support for 1 second without damage, owing to excessive overloads with secondary short circuits.

APPLICATIONS

- BS EN61010-1
- EN60044-1
- UL recognized file no: E257877

The range of TE's Crompton Instruments Ebony current transformers offers wide system current ratings, apertures, busbar and case sizes to suit every application. Manufactured to meet EN 60044 the range benefits include ratio rating from 1/5 to 6000/5, accuracy up to class 0.5, integral terminal cover for safety and multiple mounting options.

BENEFITS

- Wide range of apertures and case sizes
- Reduction of high currents for ease of metering
- Long product life

CONSTRUCTION

The toroidal core and secondary winding is encapsulated by a self-extinguishing polycarbonate moulded case cover providing excellent mechanical strength and electrical insulation. The material is halogen free thus reducing risk of halogen emissions in case of fire. The integral covered secondary terminals offer protection to IP20B and the enclosure is protected to IP40.

INSTALLATION OPTIONS

- Plug-in metal feet for wall or base mounting
- Plastic DIN-rail clips for DIN-rail mounting
- Moulded busbar mounting
- Primary copper busbar mounting
- Multi busbar mounting for two busbars

SPECIFICATIONS

System voltage:	720 V maximum
Test voltage:	3 kV for 1 minute
System frequency:	50/60 Hz
Short circuit thermal current (I_{th})*:	60 x rated primary current for 1 second
Overload withstand:	1.2 x rated current continuously
Dynamic current (I_{dyn})*:	= 2.55 x I_{th}
Saturation coefficient:	<5 for through aperture models <10 for wound primary
Service temperature:	-20°C to 85°C
Insulation class:	Class E BS2757 IEC 85
Enclosure code:	IP40
Integral terminal cover:	IP20B
Complies with:	IEC60044-1:2003
Humidity:	Up to 95% RH (non condensing)
Secondary terminals screw clamp:	Up to 10 mm ² cable
'Fast On':	6.3 mm type

LOSS IN COPPER WIRES BETWEEN INSTRUMENT AND CT FOR 5A SECONDARY

WIRE SECTION IN MM ²	LOSS IN VA (FOR BOTH WIRES)					
	1M	2M	4M	6M	8M	10M
1.5	0.60	1.19	2.38	3.57	4.76	5.95
2.5	0.36	0.71	1.43	2.14	2.86	3.57
4	0.22	0.45	0.89	1.34	1.79	2.23
6	0.15	0.30	0.60	1.89	1.19	1.49
10	0.09	0.18	0.36	0.54	0.71	0.89

LOSS IN COPPER WIRES BETWEEN INSTRUMENT AND CT FOR 1A SECONDARY

WIRE SECTION IN MM ²	LOSS IN VA (FOR BOTH WIRES)					
	10M	20M	40M	60M	80M	100M
1	0.36	0.71	1.43	2.14	2.86	3.57
1.5	0.24	0.48	0.95	1.43	1.90	2.38
2.5	0.14	0.29	0.57	0.86	1.14	1.43
4	0.09	0.18	0.36	0.54	0.71	0.89
6	0.06	0.12	0.24	0.36	0.48	0.60
10	0.04	0.07	0.14	0.21	0.29	0.36

Ebony moulded case current transformers

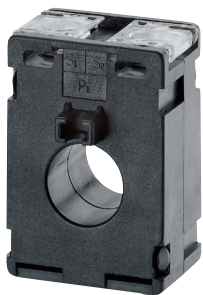

M53Q RANGE

Case size: 45 mm wide x 30 mm deep x 65 mm high
 1.8" wide x 1.2" deep x 2.5" high
 Aperture: 20 x 6 mm and 21 mm diameter
 0.8" x 0.2" and 0.8" diameter
 Weight: 0.25 kg

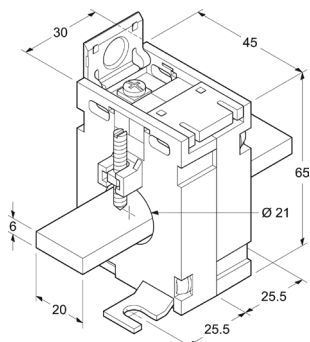

- Mounting feet centres 26 mm x 51 mm

MODEL TYPE	PRIMARY CURRENT	VA AT CLASS 3	VA AT CLASS 1
M53Q-50/5	50	1	-
M53Q-60/5	60	1.25	-
M53Q-75/5	75	1.5	-
M53Q-80/5	80	1.25	-
M53Q-100/5	100	2.5	1.5
M53Q-125/5	125	3	2.5
M53Q-150/5	150	3.75	2.5
M53Q-200/5	200	5	3.75
M53Q-250/5	250	-	5
M53Q-300/5	300	7.5	5

ORDERING CODES

- As above. Change end suffix to depict required secondary. For example: M53Q-50/1
- M50-DINCLIP. DIN-rail mounting clip for DIN-rail mounting option (2 required)



M55E RANGE

Case size: 50 mm wide x 50 mm deep x 80 mm high
 2" wide x 2" deep x 3.1" high
 Aperture: 15 x 5 mm and 16 mm diameter
 0.6" x 0.2" diameter
 Weight: 0.4 kg

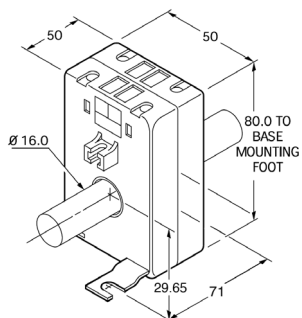

- Mounting feet centres 33 mm x 71 mm

MODEL TYPE	PRIMARY CURRENT	VA AT CLASS 3	VA AT CLASS 1
M55E-30/5	30	1.25	-
M55E-40/5	40	2.5	-
M55E-50/5	50	2.5	-
M55E-60/5	60	3.75	2.5
M55E-75/5	75	5	3.75
M55E-80/5	80	5	3.75
M55E-100/5	100	7.5	5

ORDERING CODES

- As above. Change end suffix to depict required secondary. For example: M55E-50/1
- M50-DINCLIP. (2 required)

Ebony moulded case current transformers



M53J RANGE

Case size: 50 mm wide x 30 mm deep x 80 mm high

2" wide x 1.2" deep x 3.1" high

Aperture: 30 x 10 mm, 25 x 15 mm and 20 x 20 mm and 25 mm diameter

1.2" x 0.4", 1" x 0.6" and 0.8" x 0.8" and 1.0" diameter

Weight: 0.22 kg

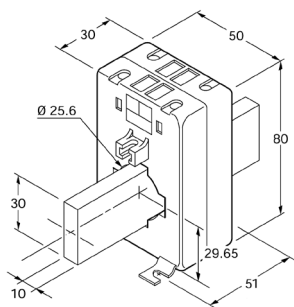

- Mounting feet centres 33 mm x 51 mm

MODEL TYPE	PRIMARY CURRENT	VA AT CLASS 3	VA AT CLASS 1
M53J-100/5	100	1.25	-
M53J-125/5	125	1.25	-
M53J-150/5	150	2.5	-
M53J-160/5	160	2.5	-
M53J-200/5	200	2.5	2.5
M53J-250/5	250	3.75	2.5
M53J-300/5	300	5	3.75
M53J-400/5	400	7.5	3.75

ORDERING CODES

- As above. Change end suffix to depict required secondary. For example: M53J-150/1
- M50-DINCLIP. DIN-rail mounting clip for DIN-rail mounting option (2 required)



M65F RANGE

Case size: 60 mm wide x 50 mm deep x 94 mm high

2.4" wide x 2" deep x 3.7" high

Aperture: 20 x 10 mm and 23 mm diameter

0.8" x 0.4", 0.9" diameter

Weight: 0.4 kg

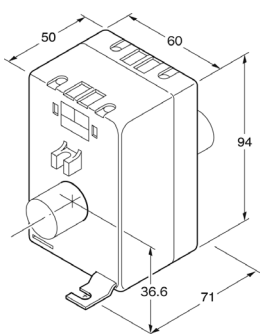

- Mounting feet centres 42 mm x 71 mm

MODEL TYPE	PRIMARY CURRENT	VA AT CLASS 3	VA AT CLASS 1	VA AT CLASS 0.5
M65F-30/5	30	1.25	-	-
M65F-40/5	40	2.5	-	-
M65F-50/5	50	2.5	-	-
M65F-60/5	60	3.75	-	-
M65F-75/5	75	5	2.5	-
M65F-80/5	80	5	2.5	-
M65F-100/5	100	7.5	5	2.5
M65F-125/5	125	7.5	5	2.5
M65F-150/5	150	15	10	5
M65F-200/5	200	20	15	7.5
M65F-250/5	250	20	20	10
M65F-300/5	300	30	30	10

ORDERING CODES

- As above. Change end suffix to depict required secondary. For example: M65F-150/1
- M50-DINCLIP. DIN-rail mounting clip for DIN-rail mounting option (2 required)

Consult factory for availability and lead time on 1A secondary.

Ebony moulded case current transformers



M63N RANGE

Case size: 60 mm wide x 30 mm deep x 94 mm high
 2.3" wide x 1.2" deep x 3.7" high
 Aperture: 40 x 10 mm and 32 mm diameter
 1.5" x 0.4" and 1.2" diameter
 Weight: 0.3 kg

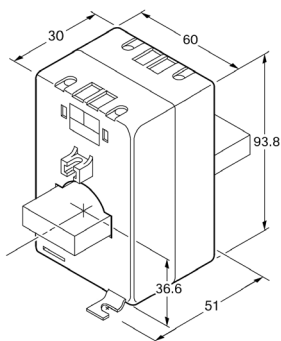

- Mounting feet centres 42 mm x 51 mm

MODEL TYPE	PRIMARY CURRENT	VA AT CLASS 3	VA AT CLASS 1	VA AT CLASS 0.5
M63N-200/5	200	2.5	-	-
M63N-250/5	250	3.75	2.5	-
M63N-300/5	300	5	3.75	-
M63N-400/5	400	7.5	5	-
M63N-500/5	500	10	7.5	3.75
M63N-600/5	600	10	7.5	5
M63N-750/5	750	15	10	7.5
M63N-800/5	800	15	10	7.5

ORDERING CODES

- As above. Change end suffix to depict required secondary. For example: M53J-150/1
- M50-DINCLIP. DIN-rail mounting clip for DIN-rail mounting option (2 required)



MA5G RANGE

Case size: 77 mm wide x 50 mm deep x 116 mm high
 3" wide x 2" deep x 4.5" high
 Aperture: 40 x 10 mm, 30 x 30 mm and 36 mm diameter
 1.6" x 0.4", 1.2" x 1.2" and 1.4" diameter
 Weight: 0.6 kg

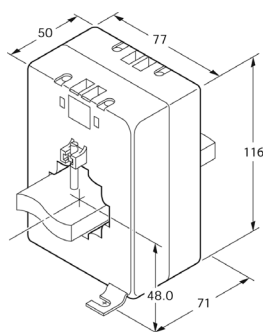

- Mounting feet centres 58.5 mm x 71 mm

MODEL TYPE	PRIMARY CURRENT	VA AT CLASS 3	VA AT CLASS 1	VA AT CLASS 0.5
MA5G-100/5	100	2.5	-	-
MA5G-125/5	125	5	2.5	-
MA5G-150/5	150	5	3.75	-
MA5G-200/5	200	10	5	2.5
MA5G-250/5	250	10	7.5	5
MA5G-300/5	300	10	7.5	5
MA5G-400/5	400	10	7.5	5
MA5G-500/5	500	10	7.5	5
MA5G-600/5	600	10	10	7.5
MA5G-750/5	750	15	10	10
MA5G-800/5	800	15	10	10
MA5G-1000/5	1000	20	15	15

ORDERING CODES

- As above. Change end suffix to depict required secondary. For example: MA5G-150/1
- M50-DINCLIP. DIN-rail mounting clip for DIN-rail mounting option (2 required)

Consult factory for availability and lead time on 1A secondary.

Ebony moulded case current transformers

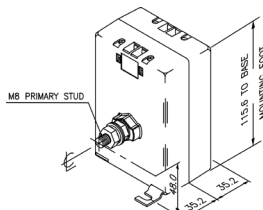

- Mounting feet centres 58.5 mm x 71 mm

MA5Y RANGE

Case size: 77 mm wide x 50 mm deep x 116 mm high

3" wide x 2" deep x 4.5" high

Fixing: M8 stud primary bar

Weight: 0.45 kg

MODEL TYPE	PRIMARY CURRENT	VA AT CLASS 3	VA AT CLASS 1
MA5Y-1/5	1	7.5	5
MA5Y-5/5	5	7.5	5
MA5Y-10/5	10	7.5	5
MA5Y-15/5	15	7.5	5
MA5Y-20/5	20	7.5	5
MA5Y-30/5	30	7.5	5
MA5Y-40/5	40	7.5	5

ORDERING CODES

- As above. Change end suffix to depict required secondary. For example: MA5Y-1/1
- M50-DINCLIP. DIN-rail mounting clip for DIN-rail mounting option (2 required)

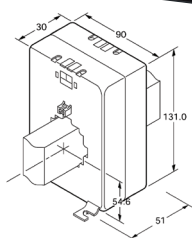

- Mounting feet centres 71.5 mm x 51 mm

M93L RANGE

Case size: 90 mm wide x 30 mm deep x 131 mm high

3.5" wide x 1.2" deep x 5.1" high

Aperture: 50 x 10 mm, 40 x 30 mm and 42 mm diameter

2" x 0.4", 1.5" x 1.2" and 1.6" diameter

Weight: 0.45 kg

MODEL TYPE	PRIMARY CURRENT	VA AT CLASS 3	VA AT CLASS 1	VA AT CLASS 0.5
M93L-400/5	400	15	7.5	3.75
M93L-500/5	500	20	15	5
M93L-600/5	600	30	20	10
M93L-750/5	750	20	15	7.5
M93L-800/5	800	20	15	10
M93L-1000/5	1000	20	20	15
M93L-1200/5	1200	30	30	20
M93L-1250/5	1250	30	30	20
M93L-1500/5	1500	30	30	20
M93L-1600/5	1600	30	30	20

ORDERING CODES

- As above. Change end suffix to depict required secondary. For example: M93L-1000/1
- M30-DINCLIP. DIN-rail mounting clip for DIN-rail mounting option (2 required)

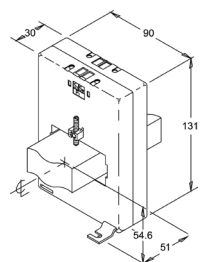

- Mounting feet centres 71.5 mm x 51 mm

M93R RANGE

Case size: 90 mm wide x 30 mm deep x 131 mm high

3.5" wide x 1.2" deep x 5.1" high

Aperture: 64 x 12.6 mm, 60 x 30 mm

2.5" x 0.5", 2.4" x 1.2"

Weight: 0.6 kg

MODEL TYPE	PRIMARY CURRENT	VA AT CLASS 3	VA AT CLASS 1	VA AT CLASS 0.5
M93R	800/5	10	10	5
M93R	1000/5	10	10	7.5
M93R	1200/5	10	15	10
M93R	1250/5	10	15	10
M93R	1500/5	10	20	15
M93R	1600/5	10	20	15
M93R	2000/5	10	20	20

ORDERING CODES

- As above. Change end suffix to depict required secondary. For example: M93R-1000/1
- M30-DINCLIP. DIN-rail mounting clip for DIN-rail mounting option (2 required)



Ebony moulded case current transformers

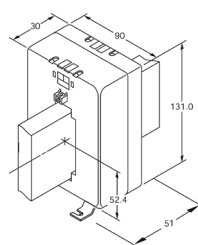

- Mounting feet centres 71.5 mm x 51 mm

M93S RANGE

Case size: 90 mm wide x 30 mm deep x 131 mm high
 3.5" wide x 1.2" deep x 5.1" high
 Aperture: 76.5 x 19 mm, 60 x 30 mm
 3.0" x 0.7", 2.4" x 1.2"
 Weight: 0.7 kg

MODEL TYPE	PRIMARY CURRENT	VA AT CLASS 3	VA AT CLASS 1	VA AT CLASS 0.5
M93S-800/5A	800	10	10	5
M93S-1000/5A	1000	150	10	7.5
M93S-1200/5A	1200	20	15	10
M93S-1250/5A	1250	20	20	15
M93S-1500/5A	1500	20	20	15
M93S-1600/5A	1600	30	20	15
M93S-2000/5	2000	30	20	15

ORDERING CODES

- As above. Change end suffix to depict required secondary. For example: M93S-1000/1
- M50-DINCLIP. DIN-rail mounting clip for DIN-rail mounting option (2 required)

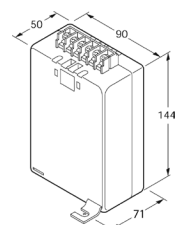

- Mounting feet centres 71.5 mm x 71 mm

S95P RANGE

Case size: 90 mm wide x 50 mm deep x 144 mm high
 3.5" wide x 2" deep x 5.7" high
 Weight: 0.9 kg - 1.1 kg

MODEL TYPE	PRIMARY CURRENT	VA AT CLASS 1
S95P-5/5	5 + 5 = 5	5
S95P-5/5/5	5 + 5 + 5 = 5	5

ORDERING CODES

- As above. Change end suffix to depict required secondary. For example: S95P-1/1
- M50-DINCLIP. DIN-rail mounting clip for DIN-rail mounting option (2 required)

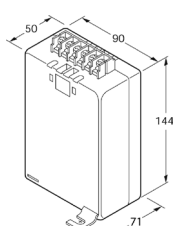

- Mounting feet centres 71.5 mm x 91 mm

S97P RANGE

Case size: 90 mm wide x 50 mm deep x 144 mm high
 3.5" wide x 2" deep x 5.7" high
 Weight: 0.9 kg - 1.1 kg

MODEL TYPE	PRIMARY CURRENT	VA AT CLASS 1
S97P-5/5/5/5	5 + 5 + 5 + 5 = 5	5
S97P-5/5/5/5/5	5 + 5 + 5 + 5 + 5 = 5	5
S97P-5/5/5/5/5/5	5 + 5 + 5 + 5 + 5 + 5 = 5	5

ORDERING CODES

- As above. Change end suffix to depict required secondary. For example: S95P-1/1

Consult factory for availability and lead time on 1A secondary.

Ebony moulded case current transformers

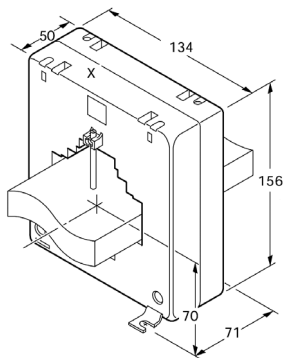
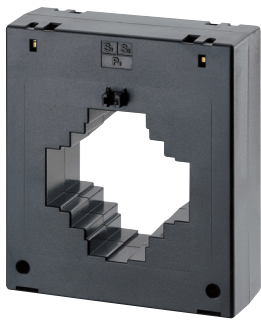

- Mounting feet centres 105 mm x 71 mm
- Mounting hole centres 110 mm x 6.6 mm

MB5D RANGE

Case size: 134 mm wide x 50 mm deep x 156 mm high

5.2" wide x 2" deep x 6.1" high

Aperture: 80 x 30 mm, 60 x 30 mm, 50 X 50 mm and 63 mm diameter

3.1" x 1.2", 2.3" x 1.2", 2 x 2" and 2.4" diameter

Weight: 0.5 kg

MODEL TYPE	PRIMARY CURRENT	VA AT CLASS 3	VA AT CLASS 1	VA AT CLASS 0.5
MB5D-400/5	400	15	10	7.5
MB5D-500/5	500	20	15	10
MB5D-600/5	600	15	10	5
MB5D-750/5	750	15	10	5
MB5D-800/5	800	20	15	7.5
MB5D-1000/5	1000	22.5	20	10
MB5D-1200/5	1200	30	20	15
MB5D-1250/5	1250	30	20	15
MB5D-1500/5	1500	30	20	15
MB5D-1600/5	1600	40	30	20
MB5D-2000/5	2000	50	40	30

ORDERING CODES

- As above. Change end suffix to depict required secondary. For example: MB5D-1600/1

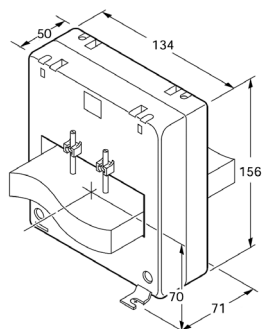

- Mounting feet centres 105 mm x 71 mm
- Mounting hole centres 110 mm x 6.6 mm

MB5Z RANGE

Case size: 134 mm wide x 50 mm deep x 156 mm high

5.2" wide x 2" deep x 6.1" high

Aperture: 104 x 35 mm, 35 mm diameter

4" x 1.3" and 1.3" diameter

Weight: 0.7 kg

MODEL TYPE	PRIMARY CURRENT	VA AT CLASS 3	VA AT CLASS 1	VA AT CLASS 0.5
MB5Z-750/5	750	15	7.5	2.5
MB5Z-800/5	800	20	10	2.5
MB5Z-1000/5	1000	22.5	15	7.5
MB5Z-1200/5	1200	30	20	10
MB5Z-1250/5	1250	30	20	15
MB5Z-1500/5	1500	30	20	15
MB5Z-1600/5	1600	30	20	15
MB5Z-2000/5	2000	30	20	15
MB5Z-2400/5	2400	30	20	15
MB5Z-2500/5	2500	30	20	15
MB5Z-3000/5	3000	30	20	15
MB5Z-4000/5	4000	30	20	15

ORDERING CODES

- As above. Change end suffix to depict required secondary. For example: MB5Z-1600/1

Consult factory for availability and lead time on 1A secondary.

Ebony moulded case current transformers

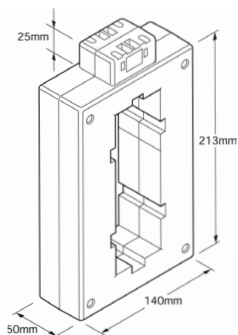

- Hole for M6 diameter screws or busbar mounting

MC5T RANGE

Case size: 140 mm wide x 50 mm deep x 238 mm high

5.5" wide x 2" deep x 9.3" high

Aperture: 160 x 50 mm

6.3" x 2"

Weight: +/-1.5kg

MODEL TYPE	PRIMARY CURRENT	VA AT CLASS 3	VA AT CLASS 1	VA AT CLASS 0.5
MC5T-1600/5	1600	45	30	20
MC5T-2000/5	2000	45	30	20
MC5T-2500/5	2500	60	45	30
MC5T-3000/5	3000	60	45	30
MC5T-3200/5	3200	60	45	30
MC5T-4000/5	4000	60	45	30
MC5T-5000/5	5000	60	45	30
MC5T-6000/5	6000	60	45	30

ORDERING CODES

- As above. Change end suffix to depict required secondary. For example: MC5T-1600/1

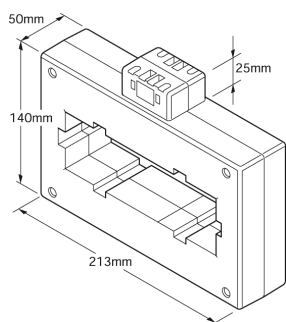
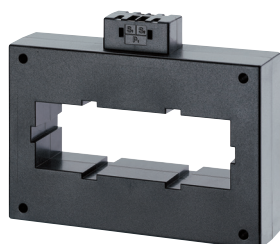

- Hole for M6 diameter screws or busbar mounting

MD5T RANGE

Case size: 213 mm wide x 50 mm deep x 165 mm high

8.3" wide x 2" deep x 6.5" high

Aperture: 160 x 50 mm

6.3" x 2"

Weight: +/-1.5 kg

MODEL TYPE	PRIMARY CURRENT	VA AT CLASS 3	VA AT CLASS 1	VA AT CLASS 0.5
MD5T-1600/5	1600	45	30	20
MD5T-2000/5	2000	45	30	20
MD5T-2500/5	2500	60	45	30
MD5T-3000/5	3000	60	45	30
MD5T-3200/5	3200	60	45	30
MD5T-4000/5	4000	60	45	30
MD5T-5000/5	5000	60	45	30
MD5T-6000/5	6000	60	45	30

ORDERING CODES

- As above. Change end suffix to depict required secondary. For example: MD5T-1600/1

Consult factory for availability and lead time on 1A secondary.

TE Connectivity Ltd. is a \$14 billion global technology and manufacturing leader creating a safer, sustainable, productive, and connected future. For more than 75 years, our connectivity and sensor solutions, proven in the harshest environments, have enabled advancements in transportation, industrial applications, medical technology, energy, data communications, and the home. With 80,000 employees, including more than 8,000 engineers, working alongside customers in approximately 140 countries, TE ensures that EVERY CONNECTION COUNTS. Learn more at www.te.com and on [LinkedIn](#), [Facebook](#), [WeChat](#) and [Twitter](#).

Generation

- Conventional Power
- Nuclear Power
- Wind/Solar
- Hydro-electric

Transmission & Distribution

- Substation
- Underground
- Overhead
- Street Lighting

Industry

- Mining
- Petrochemical
- Railway
- Shipbuilding

WHEREVER ELECTRICITY FLOWS, YOU'LL FIND TE ENERGY



te.com/energy

FOR MORE INFORMATION: TE Technical Support Centres

USA:	+1 800 327 6996
UK:	+44 1376 509 401
Australia:	+61 1300 656 090
Singapore:	+65 6590 5151
Hong Kong:	+852 2790 9609

crompton-instruments.com

© 2018 TE Connectivity Ltd. family of companies. All Rights Reserved. EPP-3247-12/18

TE Connectivity, the TE connectivity (logo) and Crompton Instruments are trademarks of the TE Connectivity Ltd. family of companies. Other logos, product and Company names mentioned herein may be trademarks of their respective owners. While TE has made every reasonable effort to ensure the accuracy of the information in this brochure, TE does not guarantee that it is error-free, nor does TE make any other representation, warranty or guarantee that the information is accurate, correct, reliable or current. TE reserves the right to make any adjustments to the information contained herein at any time without notice. TE expressly disclaims all implied warranties regarding the information contained herein, including, but not limited to, any implied warranties of merchantability or fitness for a particular purpose. The dimensions in this brochure are for reference purposes only and are subject to change without notice. Specifications are subject to change without notice. Consult TE for the latest dimensions and design specifications.



SCATTERGOOD & JOHNSON LTD

ELECTRICAL ENGINEERING & FLUID CONTROL DISTRIBUTORS

Est.1899

At Scattergood & Johnson Ltd, we pride ourselves on being a technical distributor to specialist industries.

Working with a range of quality product suppliers across a number of specialist markets, we are not your average 'box shifter' - we are your technical and supply chain partner.

We fully support every product we sell - for free! Our internal team and external sales engineers can answer any product or application question, no matter the complexity.

Backing up this technical ability is a range of 50,000+ products available from stock for nationwide next day delivery (same day if required!), or you can collect what you need from any of our trade counters around the UK.

Select your specialist interest below to learn more about how we can help.

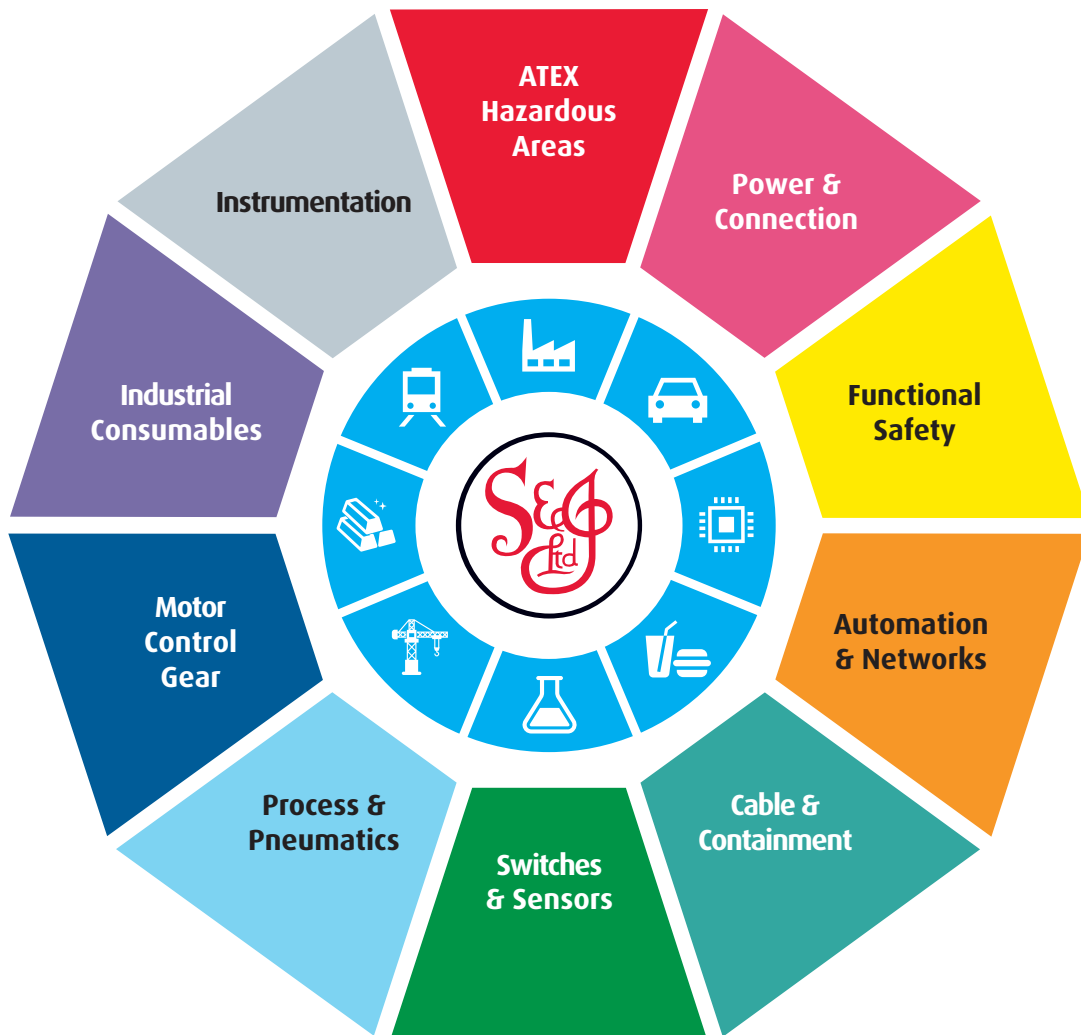

Online, In Branch and On the Road - Scattergood & Johnson Ltd, there when you need us.

www.scatts.co.uk