

SPX/SPZ **SPARTAN**

High Power Luminaire Range - Installation Guide

Zone 1 and 21 Variant CML 17ATEX1148 & IEC Ex CML17.0074

Zone 2 and 22 Variant CML 17ATEX4149 & IEC Ex CML17.0074

Zone 21 Dust only Variant CML 18ATEX3161 & IEC Ex CML18.0087

This installation guide provides instructions for installing the SPARTAN HP Highbay/ Floodlight series of explosion protected floodlights.

Overview

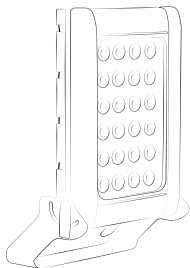

- 1 Safety Instructions
- 2 Installation
- 3 Maintenance
- 4 Technical Specification
- 5 Trouble Shooting

Important information

The SPARTAN HP series of explosion protected floodlights/highbay are specialist devices, certified for use in specific operating environments.

The units must be installed in accordance with these instructions, must be correctly certified for the specific operating environment and must be installed by suitably qualified personnel.

If you have any queries about the installation or the certification of the unit – please contact Raytec for immediate assistance and advice.

1. Safety instructions

1. Read this leaflet carefully before commencing to install the SPARTAN unit and retain it for future use. Installation can only be carried out by suitably qualified personnel.
2. Check the certification to ensure that the Zone, mains supply, ambient temperature present and 'T' ratings are suitable for the environment the unit is being installed in.
3. If the SPARTAN unit is to be installed in areas of high vibration, please consult with Raytec.
4. The SPARTAN unit housing is constructed from marine grade aluminium and toughened glass, gaskets are silicone sponge, black encapsulant and o rings are silicone rubber, inner domes on LEDs are polycarbonate. The end user must ensure that these materials are suitable for the environment the SPARTAN unit will be installed in; Zone 1 and Zone 2 Hazardous areas.
5. Check certification nameplate on side of floodlight/highbay to ascertain type of threaded cable entry on the luminaire. Select suitably certified ATEX/IEC Ex cable glands and stopper plugs, these must be parallel thread, have a minimum of 5 full thread engagement and be of a medium/fine tolerance to ISO965-1 and ISO965-3. The cable entry devices selected must maintain the IP rating of the luminaire
6. The incoming mains cable should not exceed a temperature rise of 20°C above the ambient conditions; select suitable cable.
7. To ensure the safety of the equipment, ensure that the 'flamepath' on Zone 1 variants are free from any corrosion. No repairs are possible to flameproof joints – if in doubt please consult the manufacturer.
8. External fasteners must have a yield strength of at least 600N/mm2
9. On Zone 1 variants the LED assembly contains no user serviceable parts, the luminaire must not be operated without all the individual LED polycarbonate covers in position, the IP66 rating must be maintained.

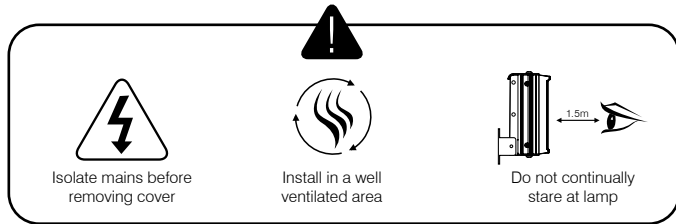

2. Installation

Mounting SPARTAN Unit

1. To meet the requirements of certification a **MINIMUM** of 2 fixing points must be used, the fixing points must be suitable for the conditions of use.
2. The line diagrams below are for guidance only – units may be mounted in any orientation

Mounting HP SPARTAN Unit – Floodlight Application

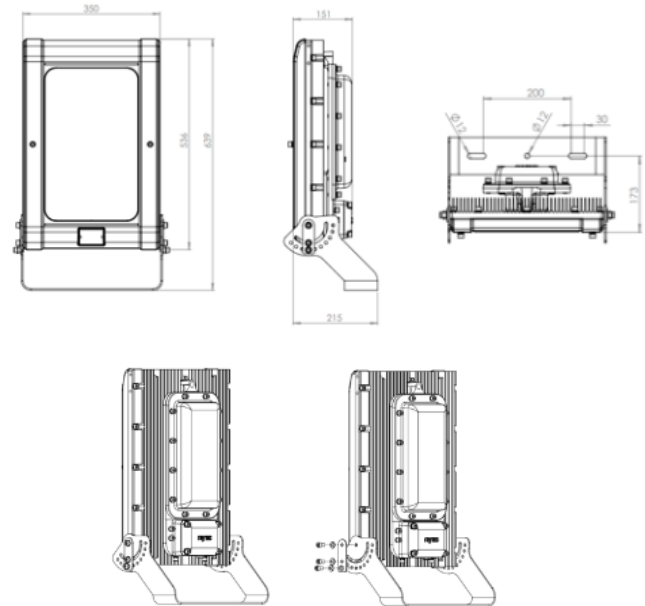

Mounting SPARTAN Unit – Highbay Application

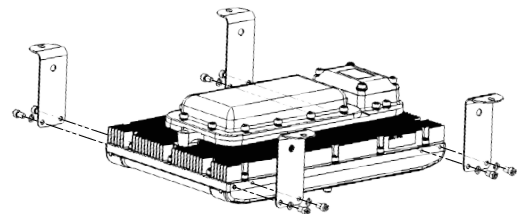
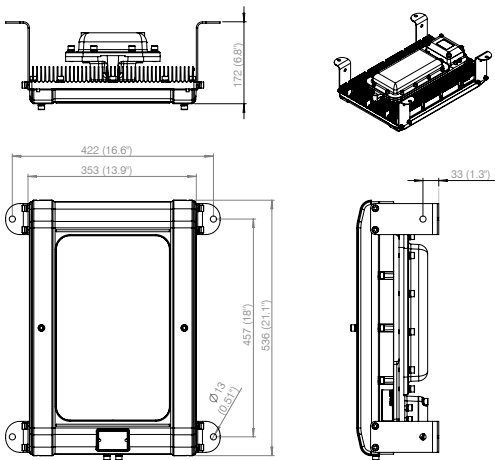

Typical wiring diagram

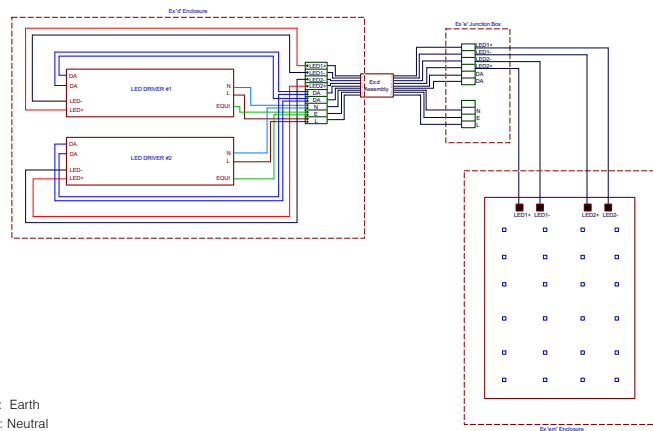

E: Earth
N: Neutral
L1: Live

Wire the Mains cable into the terminal block. Provision has been made for this and identified as the E (Earth), L (Live), Ls (Live switched) and N (Neutral) terminals. There are two pairs of contacts for each of these to facilitate a mains cable that can be looped in and out of the unit. The Ls terminals on a standard unit are not electrically connected but allows them to be used on the same circuits as *emergency bulkheads*.

3. Installer should earth the unit separately – an internal and external earth point are provided as standard
4. Connect wires to mains supply.
5. If the unit is opened for any reason, disconnect mains
6. All SPARTAN floodlights have terminal blocks suitable for looping 4mm² cable, only one cable should be connected to each terminal block connection
7. To use DALI/Dimming interface, connect the DALI terminals on the terminal block

3. Maintenance

1. It is essential that all SPARTAN units are maintained in accordance with the requirements of the EN60079-17 standard: (Electrical apparatus for explosive gas atmospheres – other than mines).
2. **IMPORTANT.** No modifications are permitted to the unit, all spare parts must be purchased from the manufacturer, unauthorized modifications or spare parts will invalidate certification and make the equipment dangerous.
3. Isolate the SPARTAN Bulkhead from the mains supply and allow to cool before carrying out any maintenance work.
4. The unit has 2 independent power supplies; in the event that a power supply needs to be replaced remove the flameproof cover to get access to the power supply. Remove the power supply from the mains terminals then remove LED red and black wires.
5. Disposal of packaging, SPARTAN units and old LED assemblies/power supplies should be carried out in accordance with national regulations.

PROTECTION/CERTIFICATION

PROTECTION/ CERTIFICATION ZONE - 1/21 VARIANTS

CML17ATEX1148 or IEC Ex CML17.0074
 II2 GD Ex db eb mb op is IIB T4 Gb
 Gb -50°C to +50°C
 Ex tb op is IIIC T104C Db
 Db -50°C to +50°C
 IP66 202-254V AC 186-250V DC or 110V-277V AC

PROTECTION/ CERTIFICATION – ZONE 2/22 VARIANTS

CML17ATEX4149 or IEC Ex CML17.0074
 II 3 GD Ex nR ec mc op is IIC T4Gc
 Gc -50°C to +50°C
 Ex tb op is IIIC T104C Dc
 Dc -50°C to +50°C
 IP66 202-254V AC 186-250V DC or 110V-277V AC

PROTECTION/CERTIFICATION – ZONE 21 DUST ONLY VARIANTS

CML18ATEX3161 or IEC Ex CML 19.0087
 Ex tb op is IIIC T104C Db
 Db -50°C to +50°C
 IP66 202-254V AC 186-250V DC or 110V-277V AC

4. Technical Specification

	150W version	300W version
Input Voltage	202-254V AC 186-250V DC or 110V-277V AC see certification nameplate on product	
Input Current (230Vac, full load)	0.7A	1.4A
Consumption	150W	300W
Power Factor (230Vac, full load)	>0.97	
Mains Frequency	50/60Hz	
Inrush Current (I_{peak} @50%)	53A, $\Delta t < 300\mu s$	60A, $\Delta t < 300\mu s$
Total Harmonic Distortion (230Vac, full load)	$\leq 3\%$	
IP Rating	IP66	
Weight (std)	22Kg	23Kg
Dimensions	See previous pages for line diagrams	
ATEX and IECEx Rating	See below	

Inrush Current Typical Curve

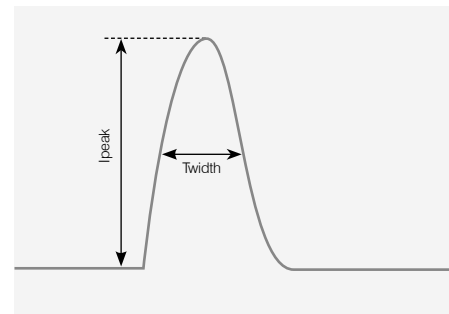

4.1 DALI Wiring Instructions

Max number of fittings allowed per MCB

MCB Type	Rating	SPZ/SPX-HP10K (120W Version)	SPZ/SPX-HP15K (180W Version)	SPZ/SPX-HP20K (240W Version)	SPZ/SPX-HP25K (300W Version)
B	10A	4	3	2	1
B	16A	10	6	4	3
B	20A	12	7	5	4
B	25A	15	10	7	6
C	10A	8	5	4	3
C	16A	16	8	6	5
C	20A	20	10	8	6
C	25A	26	16	13	9

Maximum cable length L in m

Cross section in mm ²	Maximum cable length L in m		
	25°C	50°C	75°C
0.14	31	28	26
0.50	112	102	93
0.75	168	153	140
1.00	224	204	187
1.50	300	300	281
2.00	300	300	300
2.50	300	300	300

5. Troubleshooting

1. Ensure the two LED boards are correctly wired to terminal block. Red to Red : Black to Black – paired cables
2. Ensure Mains input is correctly connected.
3. Ensure Mains Input is turned on at the source.
4. If LED panel fails to light it is possible to identify if problem is with LED panel or power supply by swapping LED cables to opposite power supply to help identify problem.

Declaration Of Conformity With The Atex Directive 2014/34/EU



Raytec Ltd. declares under our sole responsibility that the product(s) listed below conform with the relevant provisions of directive 2014/34/EU of 20th April 2016

Manufacturer	Raytec Ltd Unit 15, Wansbeck Business Park Rotary Parkway Ashington Northumberland NE63 8QW United Kingdom
Description of Equipment	Spartan range of High Power Floodlights
Notified Bodies	Sira Certification Services (0518) Unit 6 Hawarden Industrial Park Hawarden Deeside CH5 3US
Certificate numbers	CML17ATEX1148, CML17ATEX4149, IEC Ex CML 17.0074, CML18ATEX316 and, IEC Ex CML 18.0087 Quality Assurance Notification Sira (0518)
Equipment Marking	II2 GD Ex db eb mb op is IIB T4 Gb Gb -50C to +50C Ex tb op is IIIC T104C Db Db -50C to +50C IP66 202-254V AC 186-250V DC or 110V-277V AC II 3 GD Ex nR ec mc op is IIC T4Gc Gc -50 to +50C Ex tb op is IIIC T104C Dc Dc -50C to +50C IP66 202-254V AC 186-250V DC or 110V-277V AC Ex tb op is IIIC T104C Db Db -50C to +50C IP66 202-254V AC 186-250V DC or 110V-277V AC

Compliance with the Essential Health and Safety Requirements has been assessed by reference to the following standards -

- IEC 60079-0 : 2012 IEC 60079-7 : 2015 IEC 60079-1 : 2014
- IEC 60079-18 : 2015 IEC 60079-25 : 2015 IEC 60079-31 : 2014
- IEC 60079-15 : 2010

And also 2014/30/EU - EMC Directive.

Signed

Name
Position

Barry Thompson
Director of Hazardous Area Division

Dated

Serial number



rayTEC[®]

UK / Europe

T: +44 (0) 01670 520055

hazsales@rayteclcd.com

Americas

T: +1 613 270 9990

ushazsales@rayteclcd.com

www.rayteclcd.com



SCATTERGOOD & JOHNSON LTD

ELECTRICAL ENGINEERING & FLUID CONTROL DISTRIBUTORS

Est.1899

At Scattergood & Johnson Ltd, we pride ourselves on being a technical distributor to specialist industries.

Working with a range of quality product suppliers across a number of specialist markets, we are not your average 'box shifter' - we are your technical and supply chain partner.

We fully support every product we sell - for free! Our internal team and external sales engineers can answer any product or application question, no matter the complexity.

Backing up this technical ability is a range of 50,000+ products available from stock for nationwide next day delivery (same day if required!), or you can collect what you need from any of our trade counters around the UK.

Select your specialist interest below to learn more about how we can help.



Online, In Branch and On the Road - Scattergood & Johnson Ltd, there when you need us.

www.scatts.co.uk