

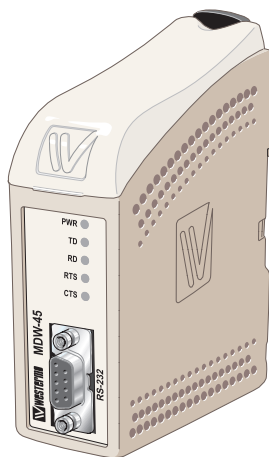

# MDW-45

Converter  
RS-232 - RS-422/485





## **General information**

### **Legal information**

The contents of this document are provided “as is”. Except as required by applicable law, no warranties of any kind, either express or implied, including, but not limited to, the implied warranties of merchantability and fitness for a particular purpose, are made in relation to the accuracy and reliability or contents of this document. Westermo reserves the right to revise this document or withdraw it at any time without prior notice.

Under no circumstances shall Westermo be responsible for any loss of data or income or any special, incidental, and consequential or indirect damages howsoever caused.

More information about Westermo can be found at the following Internet address:  
[www.westermo.com](http://www.westermo.com)

## Safety



### Before using this unit:

Read this manual completely and gather all information on the unit. Make sure that you understand it fully. Check that your application does not exceed the safe operating specifications for this unit.

Hazardous voltage may occur within this unit when connected to power supply or TNV circuits.

Prevent access to hazardous voltage by disconnecting the unit from power supply and all other electrical connections.

Prevent damage to internal electronics from electrostatic discharges (ESD) by discharging your body to a grounding point (e.g. use of wrist strap).



### Before installation:

This unit should only be installed by qualified personnel.

This unit should be built-in to an apparatus cabinet, or similar, where access is restricted to service personnel only.

The power supply wiring must be sufficiently fused, and if necessary it must be possible to disconnect manually from the power supply. Ensure compliance to national installation regulations.

This unit uses convection cooling. To avoid obstructing the airflow around the unit, follow the spacing recommendations (see Installation section).

## Care recommendations

Follow the care recommendations below to maintain full operation of unit and to fulfil the warranty obligations.

This unit must not be operating with removed covers or lids.

Do not attempt to disassemble the unit. There are no user serviceable parts inside.

Do not drop, knock or shake the unit, rough handling above the specification may cause damage to internal circuit boards.

Do not use harsh chemicals, cleaning solvents or strong detergents to clean the unit.

Do not paint the unit. Paint can clog the unit and prevent proper operation.

Do not expose the unit to any kind of liquids (rain, beverages, etc). The unit is not waterproof. Keep the unit within the specified humidity levels.

Do not use or store the unit in dusty, dirty areas, connectors as well as other mechanical part may be damaged.

If the unit is not working properly, contact the place of purchase, nearest Westermo distributor office or Westermo Tech support.

## Maintenance

No maintenance is required, as long as the unit is used as intended within the specified conditions.

## Product disposal



This symbol means that the product shall not be treated as unsorted municipal waste when disposing of it. It needs to be handed over to an applicable collection point for recycling electrical and electronic equipment.

By ensuring this product is disposed of correctly, you will help to reduce hazardous substances and prevent potential negative consequences to both environment and human health, which could be caused by inappropriate disposal.

## Simplified EU declaration of conformity

Hereby, Westermo declares that the equipment is in compliance with applicable EU directives. The full EU declaration of conformity and other detailed information are available at the respective product page at [www.westermo.com](http://www.westermo.com).

## Agency approvals and standards compliance

Type	Approval / Compliance	
EMC	EN 50121-4	Railway signalling and telecommunications apparatus
	EN 61000-6-1	Immunity residential environments
	EN 61000-6-2	Immunity industrial environments
	EN 61000-6-3	Emission residential environments
	EN 61000-6-4	Emission industrial environments
	FCC part 15	Class B
	IEC 62236-4	Railway signalling and telecommunications apparatus
Safety	EN/IEC 60950-1	IT equipment

### FCC Part 15.105 Notice:

This equipment has been tested and found to comply with the limits for a Class B digital device, pursuant to Part 15 of the FCC Rules. These limits are designed to provide reasonable protection against harmful interference in a residential installation. This equipment generates, uses and can radiate radio frequency energy and, if not installed and used in accordance with the instructions, may cause harmful interference to radio communications. However, there is no guarantee that interference will not occur in a particular installation. If this equipment does cause harmful interference to radio or television reception, which can be determined by turning the equipment off and on, the user is encouraged to try to correct the interference by one or more of the following measures:

- ⌘ Reorient or relocate the receiving antenna.
- ⌘ Increase the separation between the equipment and receiver.
- ⌘ Connect the equipment into an outlet on a circuit different from that to which the receiver is connected.
- ⌘ Consult the dealer or an experienced radio/TV technician for help.

## Type tests and environmental conditions

<b>Electromagnetic Compatibility</b>			
<b>Phenomena</b>	<b>Test</b>	<b>Description</b>	<b>Level</b>
ESD	EN 61000-4-2	Enclosure contact	± 6 kV
		Enclosure air	± 8 kV
RF field AM modulated	IEC 61000-4-3	Enclosure	10 V/m 80% AM (1 kHz), 80 – 1 000 MHz 20 V/m 80% AM (1 kHz), 800 – 960 MHz 20 V/m 80% AM (1 kHz), 1 400 – 2 700 MHz
RF field 900 MHz	ENV 50204	Enclosure	20 V/m pulse modulated 200 Hz, 900 ± 5 MHz
Fast transient	EN 61000-4-4	Signal ports	± 2 kV
		Power ports	± 2 kV
Surge	EN 61000-4-5	Signal ports unbalanced	± 2 kV line to earth, ± 2 kV line to line
		Signal ports balanced	± 2 kV line to earth, ± 1 kV line to line
		Power ports	± 2 kV line to earth, ± 2 kV line to line
RF conducted	EN 61000-4-6	Signal ports	10V 80% AM (1 kHz), 0.15 – 80 MHz
		Power ports	10V 80% AM (1 kHz), 0.15 – 80 MHz
Magnetic field, power freq.	EN 61000-4-8	Enclosure	100 A/m, 50 Hz, 16.7 Hz & 0 Hz
Pulse Magnetic field	EN 61000-4-9	Enclosure	300 A/m, 6.4 / 16 ms pulse
Voltage dips and interruption	EN 61000-4-11	AC power ports	10, 20 & 5000 ms, interruptions
			10 & 500 ms, 30% reduction 100, 200 & 1 000 ms, 60% reduction
Mains freq. 50 Hz	EN 61000-4-16	Signal ports	100V 50 Hz
Mains freq. 50 Hz	SS 436 15 03	Signal ports	250V 50 Hz
Voltage dips and interruption	EN 61000-4-29	DC power ports	10 & 100 ms, interruption
			10 ms, 30% reduction 10 ms, 60% reduction +20% above & -20% below rated voltage
Radiated emission	EN 55022	Enclosure	Class B
	FCC part 15		Class B
Conducted emission	EN 55022	AC power ports	Class B
	FCC part 15	AC power ports	Class B
	EN 55022	DC power ports	Class B
Dielectric strength		Signal port to all other	2 kVrms 50 Hz 1min
		Power port to all other	3 kVrms 50 Hz 1min 2 kVrms 50 Hz 1min (@ rated power < 60V)
<b>Environmental</b>			
Temperature		Operating	-40 to +70°C
		Storage & Transport	-40 to +70°C
Humidity		Operating	5 to 95% relative humidity
		Storage & Transport	5 to 95% relative humidity
Altitude		Operating	2 000 m / 70 kPa
Service life		Operating	10 year
Vibration	IEC 60068-2-6	Operating	7.5 mm, 5 – 8 Hz 2 g, 8 – 500 Hz
Shock	IEC 60068-2-27	Operating	15 g, 11 ms
<b>Packaging</b>			
Enclosure, MDW-45	UL 94	PC / ABS	Flammability class V-1
Dimension W x H x D			35 x 121 x 119 mm
Weight			0.19 kg
Degree of protection	IEC 529	Enclosure	IP 21
Cooling			Convection
Mounting			Horizontal on 35 mm DIN-rail

## Functional description

The MDW-45 is an RS-422/485 to RS-232 converter. This device can be used in multidrop and point to point applications to connect devices like PCs, PLCs, drives and other automation equipment.

In 2-wire half duplex applications (RS-485) the MDW-45 can automatically control the state of the data bus based just on the data it receives. This allows the unit to be used with equipment that has no handshaking signal. The maximum transmission rate possible is 115.2 kbit/s.

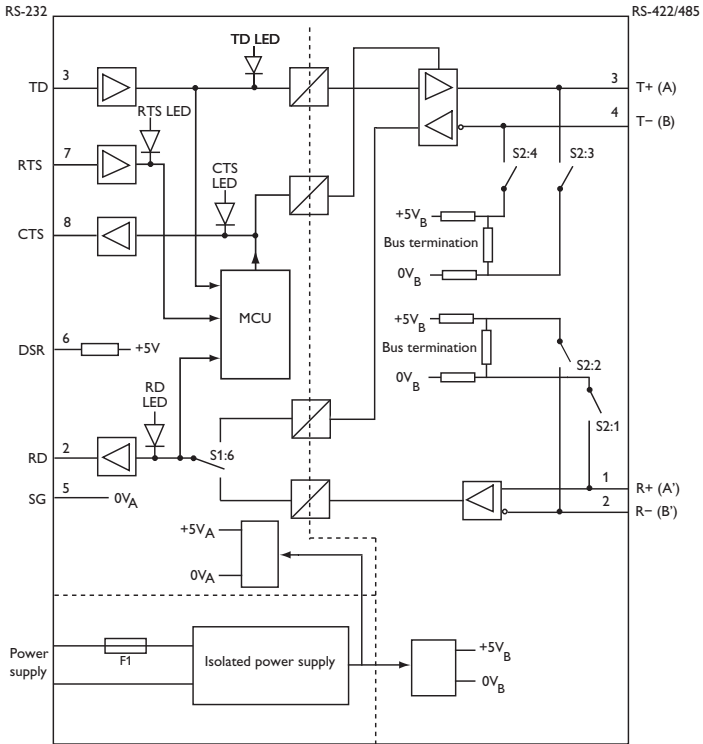

## Interface specifications

Power		
	MDW-45 LV	MDW-45 HV
Rated voltage	12 to 48 VDC	95 to 240 VAC 110 to 250 VDC
Operating voltage	9.6 to 57.6 VDC	85.5 to 264 VAC 88 to 300 VDC
Rated current	95 mA @ 12 VDC 35 mA @ 48 VDC	21 mA @ 95 VAC 10 mA @ 110 VDC
Rated frequency	DC	48 – 62 Hz / DC
Polarity	Reverse polarity protected	Polarity independent
Connection	Detachable screw terminal	Detachable screw terminal
Connector size	0.2 – 2.5 mm <sup>2</sup> (AWG 24-12)	0.2 – 2.5 mm <sup>2</sup> (AWG 24-12)

RS-422/485	
Electrical specification	RS-485
Data rate	1 200 bit/s – 115.2 kbit/s
Data format	7 or 8 data bit, Odd, even or none parity, 1 or 2 stop bit
Connection	Detachable screw terminal
Connector size	0.2 – 2.5 mm <sup>2</sup> (AWG 24-12)
Transmission range	In accordance with EIA RS-485 ≤ 1200 m, depending on data rate and cable type
Settings	120 Ω termination and failsafe biasing 680 Ω , by DIP-switch
Protection	Installation Fault Tolerant (up to ±60 V)

RS-232	
Electrical specification	RS-232
Data rate	1 200 bit/s – 115.2 kbit/s
Data format	7 or 8 data bit, Odd, even or none parity, 1 or 2 stop bit
Connection	9-pin D-sub female DCE
Transmission range	15 m

## Locations of Interface ports, LED`s and DIP-switches

S1 DIP-switch under lid  
(for details see page 10)

LED indicators  
(for details see page 8)

S2 DIP-switch  
Termination  
(for details see page 11)

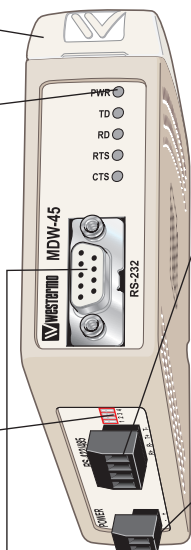

### RS-422/485 interface screw terminal

4-position	Direction*	Description
No. 1	In	R+ (A') line RS-422
No. 2	In	R- (B') line RS-422
No. 3	In/Out	T+ (A) line RS-422/485
No. 4	In/Out	T- (B) line RS-422/485

### Power connection, LV

2-position	Description
No. 1	0VDC
No. 2	12 – 48 VDC

### Power connection, HV screw terminal

2-position	Description	Product marking
No. 1	AC: Neutral DC: -Voltage	N/-
No. 2	AC: Line DC: +Voltage	L/+

### RS-232 (DCE)

9-position	Direction	Description
No. 1	-	
No. 2	Out	Received Data (RD)
No. 3	In	Transmitted Data (TD)
No. 4	-	
No. 5	-	Signal Ground (SG)
No. 6	Out	Data Set Ready (DSR)
No. 7	In	Request To Send (RTS)
No. 8	Out	Clear To Send (CTS)
No. 9	-	

### Railway installation close to the rails (RS-232, RS-422/485)

For a cable located inside 3 m boundary and connected to this port, the use of shielded cable is recommended, this to minimize the risk of interference. The cable shield should be properly connected (360°) to an earthing point within 1 m from this port. This earthing point should have a low impedance connection to the conductive enclosure of the apparatus cabinet, or similar, where the unit is built-in. This conductive enclosure should be connected to the earthing system of an installation and may be directly connected to the protective earth.

## LED Indicators

LED	Status	Description
PWR	ON	In service
	OFF	Out of service
TD	ON	Transmitted Data: Displays data received from the local RS-232 port
	OFF	No data
RD	ON	Received Data: Displays data leaving the modem on the RS-232 port
	OFF	No data
RTS	ON	Status of RTS from the RS-232 interface
	OFF	No RTS
CTS	ON	Status of CTS from the RS-232 interface
	OFF	No CTS

PWR 

TD 

RD 

RTS 

CTS 

## DIP-switch settings



### Before DIP-switch settings:

Prevent damage to internal electronics from electrostatic discharges (ESD) by discharging your body to a grounding point (e.g. use of wrist strap).

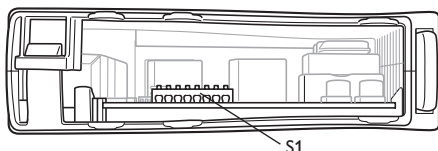

### Selection of data rate

S1 1200 bit/s

S1 2400 bit/s

S1 4800 bit/s

S1 9600 bit/s

S1 19.2 kbit/s

S1 38.4 kbit/s

S1 57.6 kbit/s

S1 115.2 kbit/s

### Selection of data format

S1 9 bit format\*

S1 10 bit format\*

S1 11 bit format\*

S1 12 bit format\*

	9	10	10	10	11	11	11	12
7 bit	●	●	●		●			
8 bit				●		●	●	●
No parity	●	●		●		●		
Parity			●		●		●	●
1 stop bit	●		●	●			●	
2 stop bit		●			●	●		●

\* See Supervision table when selecting data bits. Turning time 1 – 1.5 bit time

### Selection of bus format

S1 2-wire RS-485

S1 4-wire RS-422

In RTS-control and Transmitter always active. The switches for data rate and number of bits has no effects.

### Selection of bus control

S1 Data control

S1 RTS-control

S1 Transmitter always active

**S2 Below panel, RS-422/485 termination**



No termination and fail-safe



Termination with fail-safe (2-wire)



Termination with fail-safe (4-wire)

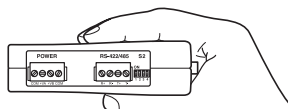

**Note!** DIP-switch alterations are only effective after a power on.

**Factory settings**



Data rate – 9600 bit/s, data format – 10 bit  
Bus format, 2-wire

**Note:** Switch 1:8 is not used



No termination  
and fail-safe

## Unit specific description

When the converter is set to data-control mode the transmitter is activated by data on TD (RS-232). The time the transmitter stays active corresponds to one character-time plus the turning time for the set data rate and number of bits. If more data arrives on TD before the turning time has expired the transmitter stays active for an additional one character time and so on. In RTS-control mode the transmitter is activated by the RS-232 RTS-signal. In this mode the dip-switches for data rate and number of bits have no effect. The LED indicators show the status of the data signals. The fail-safe termination ensures that the signal level at the receiver is in 'mark state' (differential > 0.2 Volts) when there is no data on the RS-485 bus. Full duplex is only possible if 4-wires are used.

## Field of application

RS-422 and RS-485 were both designed for multidrop applications. When a system is installed it should always form a bus structure (see diagrams). Star shaped networks should never be created; there are other Westermo products that can be used to create star net applications. To install a system according to the RS-422/485 specification it is very important that the line is terminated at the correct points. The recommendation is to terminate the receiver on the master unit and the final bus slave unit. See diagrams for details of how this is done with RS-485 (2-wire) and RS-422 (4-wire).

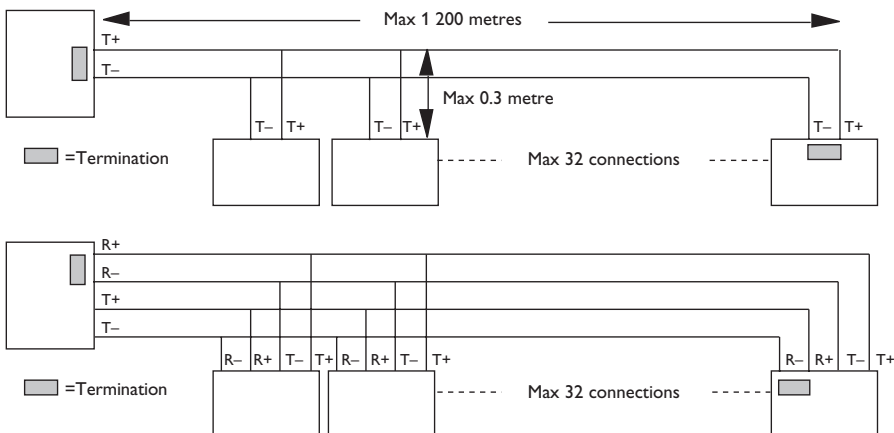

**N.B.** R+/R-, T+/T- definitions are not standard, it can help to shift + and - if the unit does not work.

## Line connection

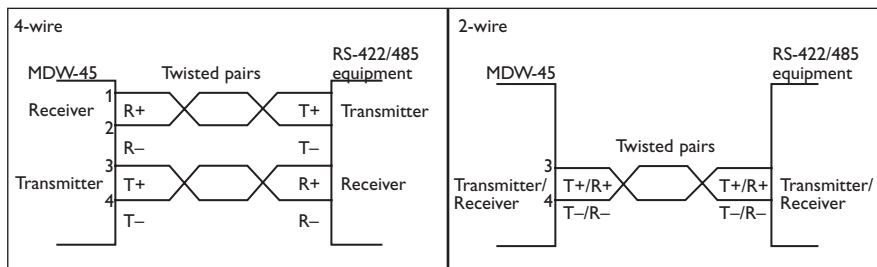

## Care recommendations

Follow the care recommendations below to maintain full operation of unit and to fulfil the warranty obligations.

- ⌘ This unit must not be operating with removed covers or lids.
- ⌘ Do not attempt to disassemble the unit.
- ⌘ There are no user serviceable parts inside.
- ⌘ Do not drop, knock or shake the unit, rough handling above the specification may cause damage to internal circuit boards.
- ⌘ Do not use harsh chemicals, cleaning solvents or strong detergents to clean the unit.
- ⌘ Do not paint the unit. Paint can clog the unit and prevent proper operation.
- ⌘ Do not expose the unit to any kind of liquids (rain, beverages, etc).  
The unit is not waterproof. Keep the unit within the specified humidity levels.
- ⌘ Do not use or store the unit in dusty, dirty areas, connectors as well as other mechanical part may be damaged.

If the unit is not working properly, contact the place of purchase, nearest Westermo distributor office or Westermo Tech support.



Westermo • SE-640 40 Stora Sundby, Sweden  
Tel +46 16 42 80 00 Fax +46 16 42 80 01  
E-mail: [info@westermo.com](mailto:info@westermo.com)  
[www.westermo.com](http://www.westermo.com)



# SCATTERGOOD & JOHNSON LTD

ELECTRICAL ENGINEERING & FLUID CONTROL DISTRIBUTORS

Est.1899

At Scattergood & Johnson Ltd, we pride ourselves on being a technical distributor to specialist industries.

Working with a range of quality product suppliers across a number of specialist markets, we are not your average 'box shifter' - we are your technical and supply chain partner.

We fully support every product we sell - for free! Our internal team and external sales engineers can answer any product or application question, no matter the complexity.

Backing up this technical ability is a range of 50,000+ products available from stock for nationwide next day delivery (same day if required!), or you can collect what you need from any of our trade counters around the UK.

Select your specialist interest below to learn more about how we can help.



Online, In Branch and On the Road - Scattergood & Johnson Ltd, there when you need us.

# [www.scatts.co.uk](http://www.scatts.co.uk)