

Instruction sheet MTL process alarm equipment

October 2016
INS DA170 Rev 11

CROUSE-HINDS
SERIES

RTK DA170 range

MTL intrinsically safe LED cluster

Introduction

This manual provides the information necessary to install, connect, test and maintain the RTK DA170 intrinsically safe LED cluster lamps.

Description

The RTK DA170 range of MTL LED clusters provides visual on/off indication of process conditions in safe and hazardous areas. Available in six super-bright colours- red, green, yellow, orange, blue and white- they are standard 22.5mm diameter and seal to IP65 to the panel door. All colours are fully current limited and take only 20mA. The input on all units is non-polarised to prevent damage by reversed supplies. The DA170 also has an optional current by-pass to divert a small amount of current from the cluster.

In hazardous areas it is possible to combine LEDs from a single IS interface, two for IIC interfaces and four with a IIB interface.

The standard LED cluster can also be supplied fully mounted in stainless steel or polycarbonate boxes ready for immediate mounting on-site.

With the LED's lower power consumption, lower heat dissipation and far greater life expectancy the DA170 is an ideal standard indicator for safe and hazardous areas alike.

LED cluster models

Model no.	Colour	Current limited to
DA170-XX	RD,GN, AM, YW, WT, BL	20mA

The XX in the model number is replaced by the following letters to indicate the colour of the cluster lens.

RD = Red
AM = Amber
WT = White
GN = Green
YW = Yellow
BL = Blue

IS interfaces

These units can be used in gas group IIC powered through a 28V 300Ω shunt-diode safety barrier (such as the MTL7728+ unit) or an isolating interface unit (such as MTL5525 model). They include an internal current limiting device, combined with the exceptionally high efficiency of LED's used, enables two clusters to be driven through one barrier/isolator in IIC areas with consequent savings in hardware and plant cabling costs, or four through one interface when limited to IIB applications. Ambient temperature rating is up to 60°C for single and two-cluster installations and up to 40°C for four-cluster (see application configurations).

Installation

General

General assembly details for all models are shown in figure 1.

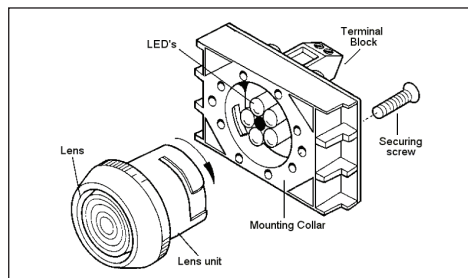

Figure 1 - general assembly

Required torque level for securing screws is 0.8-1.0Nm location

All models can be used in zones 0, 1 and 2 (equipment categories 1, 2 and 3) hazardous areas and have an external operating temperature range of -20°C to +60°C, except for IIB installations in which four DA170's are driven through one interface when the range is -20°C to + 40°C. Light output of the cluster is not seriously affected by cable resistance (see maximum cable parameters).

EATON
Powering Business Worldwide

Eaton Electric Limited,
Great Marlings, Butterfield, Luton
Beds, LU2 8DL, UK.
Tel: + 44 (0)1582 723633 Fax: + 44 (0)1582 422283
E-mail: rikenquiny@eaton.com
www.mtl-inst.com
© 2016 Eaton
All Rights Reserved
Publication No. INS DA170 Rev 11
October 2016

RTK DA170

October 2016

Operational conditions and power requirements

For installations in IIC hazardous areas, power for the clusters is provided from the safe area through intrinsically safe interface units (eg, MTL7728+ and MTL5525) from a 24/28V dc supply. Two DA170's clusters can be supplied through one interface unit while, for IIB applications only, up to four clusters can be powered through one interface.

The clusters current consumption is internally regulated to 20mA, thereby avoiding the need for external current limitation- which makes them compatible with different power supplies and simplifies many applications.

When a DA170 is used in a safe area, the power supply voltage should be limited to 14 to 26VDC.

Electrical certification and safety

The DA170 clusters are classed as 'simple apparatus' as defined by CENELEC standard EN50014 and can therefore be connected without further certification into any intrinsically safe circuit.

Any number of clusters can be included in one circuit. The category (ia or ib) and the gas group classification (IIC, IIB or IIA) of the circuit remains unchanged.

The temperature classification of the loop is determined by the available power within the loop and the required ambient temperature. For a maximum available power of 1.3W the maximum ambient temperature must not exceed 40°C and for a maximum power of 1.2W must not exceed 60°C.

The front lens, when a cluster is properly installed, is protected to a level of IP65. All models withstand 500V insulation test when conventionally mounted and also meet all other requirements relevant to simple apparatus. The lens is prevented from static build-up by a permanent antistatic coating.

Mounting the clusters

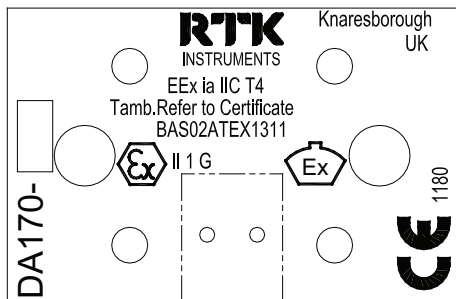
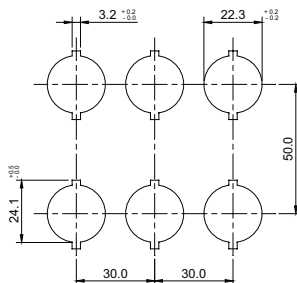
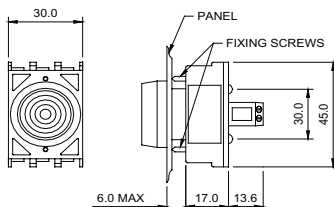

Figure 3

Mounting details are shown in figure 2 and 3. Clusters can be mounted in any instrumentation panel with a thickness up to 6mm

- Punch or drill an appropriate diameter hole in the panel for each cluster. To prevent rotation add a notch detailed below. Note that the centres of the mounting cut-outs must be at least 50mm apart either vertically or horizontally and 30mm in the other direction (without optional label-holders) or 50mm vertically and 30mm horizontally (with label holders) for label to appear above or below lamp.
- Separate the mounting collar from the lens unit by twisting the lens unit a quarter turn anticlockwise and pulling the lens unit away from the collar.
- Insert the lens unit into the hole from the front of the panel.
- From the rear of the panel, locate the mounting collar over the lens unit and lock into place by twisting the lens unit a quarter of a turn clockwise.
- Tighten the two fixing screws recessed in the mounting collar to clamp the unit in position.

Figure 2- LED cluster dimensions



RTK DA170

October 2016

Cable connections

Cable connections are made to the terminal block on the rear of each unit. The unit is non-polarised therefore the positive of the power supply can go to any terminal, with the power supply negative going to the other terminal.

Maximum cable parameters

The capacitive cable parameters associated with the recommended 28V barrier and isolator interfaces are 0.13µF in IIC and 0.39µF in IIB. This corresponds to approximately 500m and 1.5Km of cable length respectively and hence is not likely to be a problem. The inductive parameters are in all cases sufficiently large to be ignored.

Precise details of cable parameters for the particular interface used can be found in the associated literature

Labeling

For labeling, a DA-658 label holder for interchangeable labels (DA-659) is available (figure 4). The DA-659 labels are provided blank for user engraving. Figure 4 shows the engraving area and the number of characters 2.8mm or 4mm in height that can be engraved on it. During mounting, the label holder is slid onto the back of the lens unit before reconnecting the lens unit to the mounting collar through the panel.

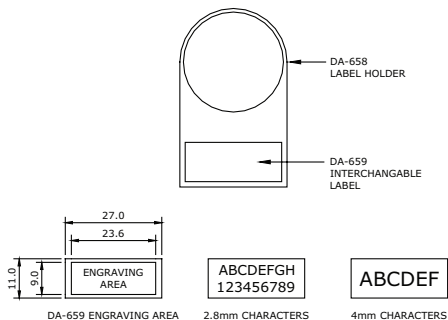

Testing

Warning

For intrinsically safe applications, make sure all testing is carried out according to the appropriate nationally accepted code of practice (eg, BS EN60079 in the UK or recommended practice ISA RP 12.6 in the USA). If fault finding is necessary, make sure permission to carry out the work is granted and/or conform to required company procedures to avoid the possibilities of causing a plant malfunction.

Testing

Clusters can be tested on site or in the workshop, using the following procedure:

Before testing in hazardous areas make sure the cluster remains connected to its intrinsically safe interface. In safe areas or workshops the voltage applied should be between 14 and 26VDC.

With a suitably certified multimeter, check that the cluster illuminates under the following conditions. The supply across the two terminals on the cluster is between 14 and 26V while the supply current taken is between 17mA and 23mA.

Application configurations

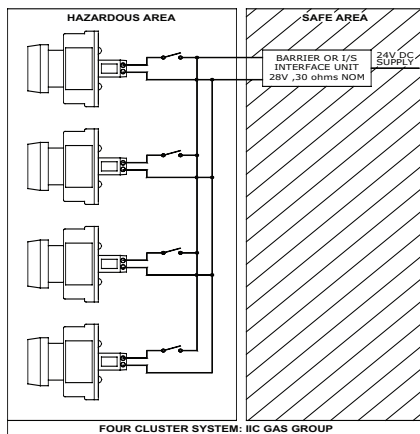
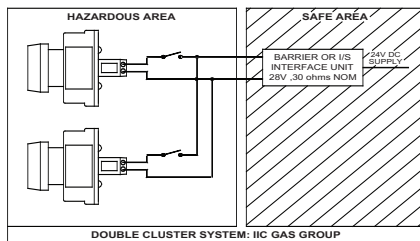
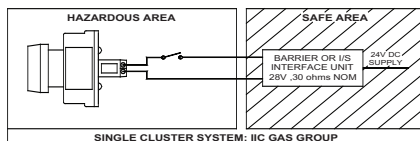

RTK DA170

October 2016

Maintenance

Routine maintenance

The only maintenance required is limited to routine periodic inspection and cleaning.

At monthly intervals (or whenever necessary)

Clean the lens with soap and water. Do not use abrasive substances or solvents to clean the lens.

At six-monthly intervals

Check that the mechanical mounting of the cluster is secure. Check that the cable connections to the cluster are secure.

Faulty units

Apart from the test operations and the maintenance procedures described above, no other repair work can be carried out by the user as there are no replaceable parts in the cluster. Faulty units should be returned to Eaton for investigation and possible replacement.

Specification

Colours

RD = Red, GN = Green, AM = Amber, YW = Yellow, WT = White, BL = Blue

Power supply requirements (Vin)

Hazardous area use

All models (with an MTL7728 safety barrier) : 22 to 26V
All models (with an MTL5525 isolator) : 20 to 35V

Safe area use

Direct connection : 14 to 26VDC

Current consumption

20mA (an optional current bypass may increase the current consumption of the unit)

Note: Useful light output from 8mA for all units

Electrical safety

Non-energy storing simple apparatus. Will not store or generate more than 1.5V, 0.1A, 20µJ or 25mW when connected to intrinsically safe equipment with a maximum open circuit voltage of not more than 40V.

Ambient temperature

Working : -40°C to +60°C (matched power to 1.2W)

Working : -40°C to +40°C (matched power to 1.3W)

Storage : -40°C to +70°C

Lifetime

100 000 hours minimum (11 years) continuously energised at 40°C ambient temperature

Humidity

5-95% RH

Casing

Housing/mounting collar : Polyamide 6.6 / reinforced fibreglass FR4

Lens: Polycarbonate (coated with anti-static coating)

Mounting

Panel, up to 6mm thickness, through 22.5mm diameter hole. Notch required to prevent rotation

Connections

Rising clamp screw terminals for cable 0.5mm² to 1.5mm²

Protection

IP65 when panel mounted.

IP20 from the rear.

Accessories

Black label holder (DA-658) with interchangeable label (DA-659)

EMC compliance

Immunity to EN61000-6-2

Emissions to EN61000-6-4

Standards: CENELEC BS EN50014 & 50020 & 50284

Approved for: Ex ia IIC T4 Ga Ⓢ II 1 G

Certificate No: BAS02ATEX1311

Safety Parameters:

Ui = 40V

Pi = 1.2W (max ambient temp. = 60°C)

Pi = 1.3W (max ambient temp. = 40°C)

Ci = Li = 0

The device can be powered from an EEx ia IIC certified interface with output parameters lower than those shown above.

Declaration of Conformity

A printed version of the Declaration of Conformity has been provided separately within the original shipment of goods. However, you can find a copy of the latest version at

<http://www.mtl-inst.com/certificates>



Eaton Electric Limited,
Great Marlings, Butterfield, Luton
Beds, LU2 8DL, UK.
Tel: + 44 (0)1582 723633 Fax: + 44 (0)1582 422283
E-mail: rtkenquiry@eaton.com
www.mtl-inst.com
© 2016 Eaton
All Rights Reserved
Publication No. INS DA170 Rev 11 12/016
October 2016

EUROPE (EMEA):
+44 (0)1582 723633
mtl-enquiry@eaton.com

THE AMERICAS:
+1 800 835 7075
mtl-us-info@eaton.com

ASIA-PACIFIC:
+65 6645 9864 / 6645 9865
sales.mtlinst@eaton.com

The given data is only intended as a product description and should not be regarded as a legal warranty of properties or guarantee. In the interest of further technical developments, we reserve the right to make design changes.



SCATTERGOOD & JOHNSON LTD

ELECTRICAL ENGINEERING & FLUID CONTROL DISTRIBUTORS

Est.1899

At Scattergood & Johnson Ltd, we pride ourselves on being a technical distributor to specialist industries.

Working with a range of quality product suppliers across a number of specialist markets, we are not your average 'box shifter' - we are your technical and supply chain partner.

We fully support every product we sell - for free! Our internal team and external sales engineers can answer any product or application question, no matter the complexity.

Backing up this technical ability is a range of 50,000+ products available from stock for nationwide next day delivery (same day if required!), or you can collect what you need from any of our trade counters around the UK.

Select your specialist interest below to learn more about how we can help.



Online, In Branch and On the Road - Scattergood & Johnson Ltd, there when you need us.

www.scatts.co.uk