

E2 mini | Series B15i·B15 | Delivery program

Snap-open along inner and outer radius



Series B15i snap-open along inner radius | Series B15 along outer radius | Standard

Snap-open along inner radius	Snap-open along outer radius		<i>Bi</i> [mm]	<i>Ba</i> [mm]	<i>R</i> Bending radii [mm]	B15i [kg/m]	B15 [kg/m]
B15i.015.R.0	B15.015.R.0		15	26	038 048 075 100 110 125 145 180	≈ 0,35	≈ 0,35
B15i.025.R.0	B15.025.R.0		25	36	038 048 075 100 110 125 145 180	≈ 0,40	≈ 0,40
B15i.038.R.0	B15.038.R.0		38	49	038 048 075 100 110 125 145 180	≈ 0,46	≈ 0,46
B15i.050.R.0	B15.050.R.0		50	61	038 048 075 100 110 125 145 180	≈ 0,52	≈ 0,52
B15i.5.R.0	B15.5.R.0		63	76	038 048 075 100 110 125 145 180	≈ 0,63	≈ 0,63
B15i.6.R.0	B15.6.R.0		80	94	038 048 075 100 110 125 145 180	≈ 0,70	≈ 0,70
B15i.7.R.0	B15.7.R.0		100	113	038 048 075 100 110 125 145 180	≈ 0,76	≈ 0,76

Before using this Series on long travels please consult igus®.

Supplement Part No. with required radius (*R*). Example: **B15.025.038.0**

Dimensions

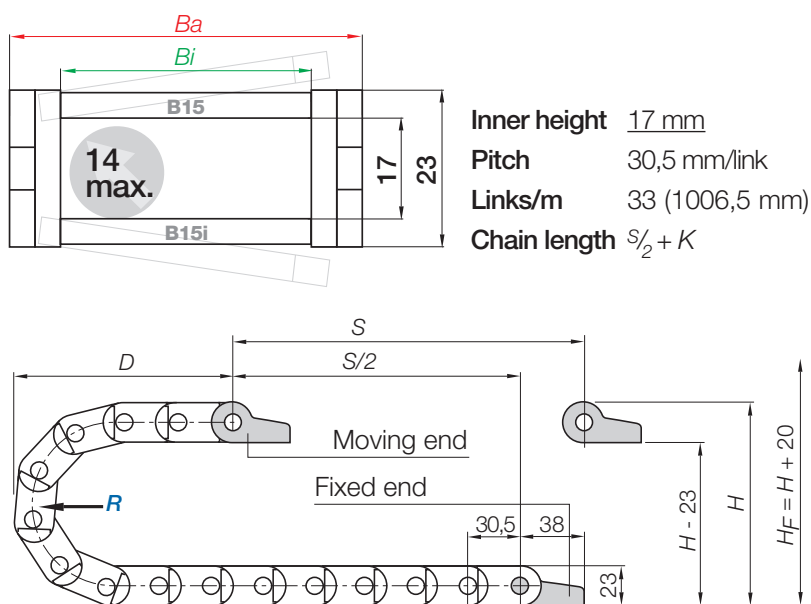
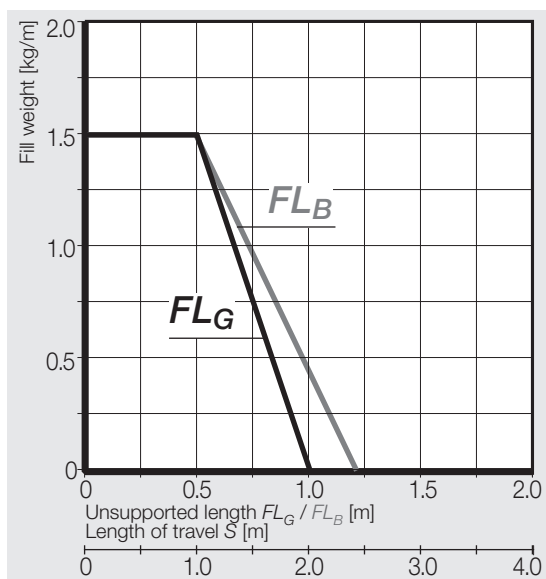

<i>R</i>	038	048	075	100	110	125	145	180
<i>H</i>	99	119	173	223	243	273	313	383
<i>D</i>	95	105	132	157	167	182	202	237
<i>K</i>	185	215	300	380	410	455	520	630

The required clearance height: $H_F = H + 20$ mm (with 0,5 kg/m fill weight)

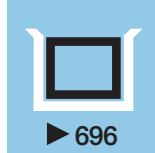

E2 mini | Series B15i·B15 | Accessories

Mounting brackets, polymer one-piece | pivoting | locking

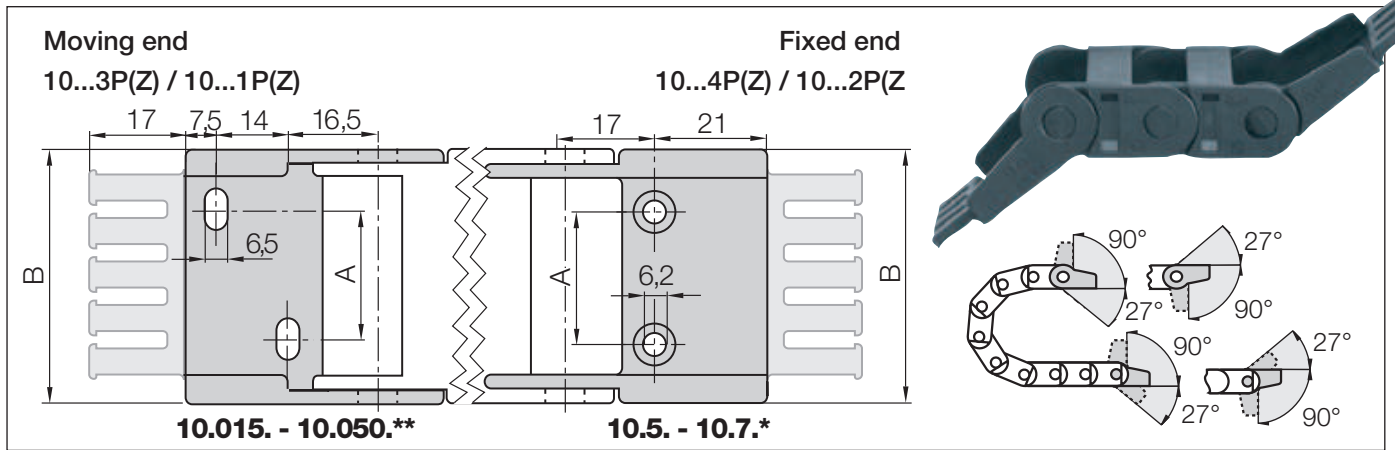

Width Index	Standard	Part No. full set pivoting:		Part No. full set locking:		Dim. A [mm]	Dim. B [mm]	Number of teeth
		with tiewrap plates	without tiewrap plates	with tiewrap plates	without tiewrap plates			
015.	▶	1015.34PZ	1015.34P	1015.12PZ	1015.12P	–	25,5	2
025.	▶	1025.34PZ	1025.34P	1025.12PZ	1025.12P	10	35,5	3
038.	▶	1038.34PZ	1038.34P	1038.12PZ	1038.12P	23	48,5	4
050.	▶	1050.34PZ	1050.34P	1050.12PZ	1050.12P	35	60,5	5
5.	▶	105. 34PZ	105. 34P	105. 12PZ	105. 12P	48	75	6
6.	▶	106. 34PZ	106. 34P	106. 12PZ	106. 12P	65	92	8
7.	▶	107. 34PZ	107. 34P	107. 12PZ	107. 12P	85	112	10

** Drilling pattern for width index: 15.015. - 15.050. see drawing left. Each valid for Moving end and Fixed end

* Drilling pattern for width index: 15.5 - 15.7. see drawing right. Each valid for Moving end and Fixed end

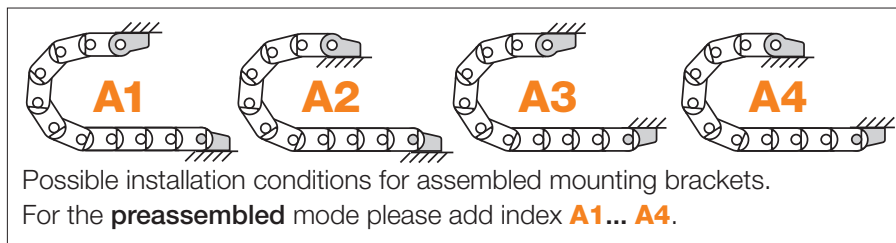

Part No. structure

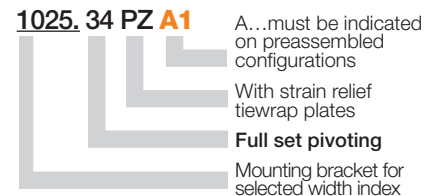

Interior separation

Slotted separator for e-chains®
unassembled **153**
assembled **154**

Slotted separator 153

Is used when vertical separation is required. Due to its slot, it allows basic vertical/horizontal shelving arrangements.

Side plate for e-chains®
unassembled **155**
assembled **156**

Side plate 155

Side plate for use with full-width shelf 110.X and slotted separator 153.

Full-width shelf for e-chains®
unassembled **110.X**
assembled **111.X**

Full-width shelf 110.X

This option makes sense in applications with many thin cables with similar diameters. For a consequent subdivision. Full-width shelves can be arranged at 3 different heights (in 5 mm increments).

Full-width shelves

Width X [mm]	unassembled	assembled	Width X [mm]	unassembled	assembled	Width X [mm]	unassembled	assembled
015	110.15	111.15	050	110.50	111.50	100	110.100	111.100
025	110.25	111.25	063	110.63	111.63			
038	110.38	111.38	080	110.80	111.80			



SCATTERGOOD & JOHNSON LTD

ELECTRICAL ENGINEERING & FLUID CONTROL DISTRIBUTORS

Est.1899

At Scattergood & Johnson Ltd, we pride ourselves on being a technical distributor to specialist industries.

Working with a range of quality product suppliers across a number of specialist markets, we are not your average 'box shifter' - we are your technical and supply chain partner.

We fully support every product we sell - for free! Our internal team and external sales engineers can answer any product or application question, no matter the complexity.

Backing up this technical ability is a range of 50,000+ products available from stock for nationwide next day delivery (same day if required!), or you can collect what you need from any of our trade counters around the UK.

Select your specialist interest below to learn more about how we can help.



Online, In Branch and On the Road - Scattergood & Johnson Ltd, there when you need us.

www.scatts.co.uk