

**BA307E, BA327E,
BA308E & BA328E**
intrinsically safe
loop-powered
panel mounting indicators
Issue 9

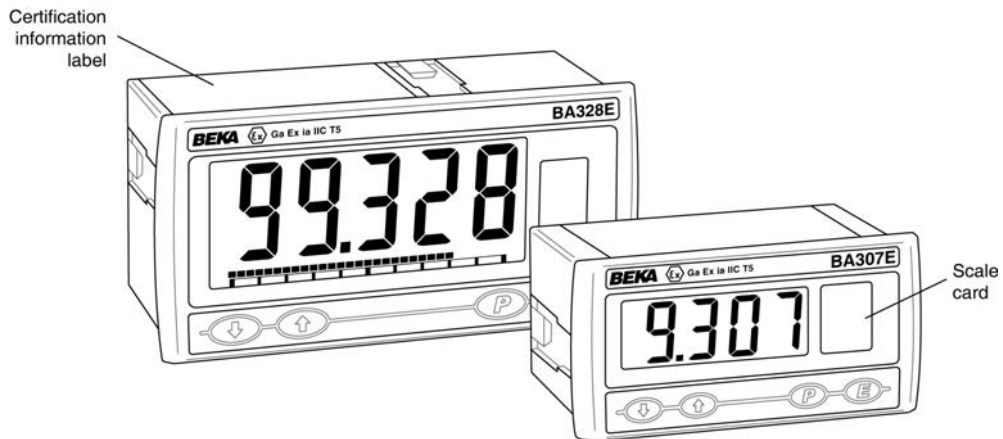

Issue: 9
5th May 2016

CONTENTS

- 1. Description**
 - 2. Operation**
 - 2.1 Controls
 - 3. Intrinsic safety certification**
 - 3.1 ATEX gas certificate
 - 3.2 Zones, gas groups & T rating
 - 3.3 Special conditions for safe use
 - 3.4 4/20mA input
 - 3.5 Certification label information
 - 4. System Design for Gas Hazardous Areas**
 - 4.1 Transmitter loops
 - 4.2 Remote indication
 - 5. Installation**
 - 5.1 Location
 - 5.2 EMC
 - 5.3 Installation procedure
 - 5.4 Scale card
 - 6. Configuration and Calibration**
 - 6.1 Summary of configuration functions.
 - 6.2 Indicator function
 - 6.3 Resolution
 - 6.4 Position of decimal point
 - 6.5 Calibration using an external current source.
 - 6.6 Calibration using internal reference.
 - 6.7 Bargraph format and calibration
 - 6.8 Function of the *P* push-button
 - 6.9 Tare function
 - 6.10 Security code
 - 6.11 Reset to factory defaults
 - 6.12 Under and over-range
 - 7. Lineariser**
 - 7.1 Lineariser calibration using an external current source.
 - 7.1.1 Example, Adding break-points to a new indicator
 - 7.2 Lineariser calibration using internal reference.
 - 7.2.1 Example, Adding break-points to a new indicator
 - 7.3 Lineariser error message
 - 7.4 Lineariser under and over-range
 - 7.5 Lineariser default configuration
 - 8. Maintenance**
 - 8.1 Fault finding during commissioning
 - 8.2 Fault finding after commissioning
 - 8.3 Servicing
 - 8.4 Routine maintenance
 - 8.5 Guarantee
 - 8.6 Customer comments
 - 9. Accessories**
 - 9.1 Scale card
 - 9.2 Tag strip
 - 9.3 Alarms
 - 9.3.1 Solid state output
 - 9.3.2 Intrinsic safety
 - 9.3.3 Configuration and adjustment.
 - 9.3.4 Alarm enable
 - 9.3.5 Setpoint adjustment
 - 9.3.6 Alarm function
 - 9.3.7 Alarm output status
 - 9.3.8 Hysteresis
 - 9.3.9 Alarm delay
 - 9.3.10 Alarm silence time
 - 9.3.11 Flash display when alarm occurs.
 - 9.3.12 Access setpoint in display mode.
 - 9.3.13 Adjusting alarm setpoint from the display mode.
 - 9.4 Display backlight
 - 9.4.1 Loop powering the backlight
 - 9.4.2 Separately powering the backlight.
- Appendix 1** ATEX dust certification
- Appendix 2** IECEx gas and dust certification
- Appendix 3** FM and cFM certification

The BA307E, BA327E, BA308E & BA328E are CE marked to show compliance with the European Explosive Atmospheres Directive 2014/34/EU and the European EMC Directive 2014/30/EU

1. DESCRIPTION

These panel mounting, intrinsically safe digital indicators display the current flowing in a 4/20mA loop in engineering units. They are loop powered but only introduce a 1.2V drop, which allows them to be installed into almost any 4/20mA current loop. No additional power supply or battery is required.

The four models are electrically similar, but have different size displays and enclosures.

Model	Display	Bezel size
BA307E	4 digits 15mm high	96 x 48mm
BA327E	5 digits 11mm high and bargraph.	96 x 48mm
BA308E	4 digits 34mm high	144 x 72mm
BA328E	5 digits 29mm high and bargraph.	144 x 72mm

This instruction manual supplements the instruction sheet supplied with each instrument.

The main application of all the models is to display a measured variable or control signal in a hazardous process area. The zero and span of the display are independently adjustable so that the indicator can be calibrated to display any variable represented by the 4/20mA current, e.g. temperature, flow, pressure or level.

All the models have been certified intrinsically safe for use in gas and dust hazardous areas by Notified Body Intertek Testing and Certification Ltd and comply with the European ATEX Directive 2014/34/EU. The EC-Type Examination certificate specifies that under fault conditions the output voltage, current and power at the 4/20mA input terminals will not exceed those specified for *simple apparatus* in Clause 5.7 of EN 60079-11, which simplifies installation and documentation.

For international applications all models have IECEx certification which is described in Appendix 2.

For applications in the USA and Canada all models have FM and cFM certification, see Appendix 3.

2. OPERATION

Fig 1 shows a simplified block diagram of all the models. The 4/20mA input current flows through resistor R1 and forward biased diode D1. The voltage developed across D1, which is relatively constant, is multiplied by a switch mode power supply and used to power the instrument. The voltage developed across R1, which is proportional to the 4/20mA input current, provides the input signal for the analogue to digital converter.

Each time a 4/20mA current is applied to the instrument, initialisation is performed during which all segments of the display are activated, after five seconds the instrument displays the input current using the calibration information stored in the instrument memory. If the loop current is too low to power the instrument the indicator will display the error message 'LPLo'.

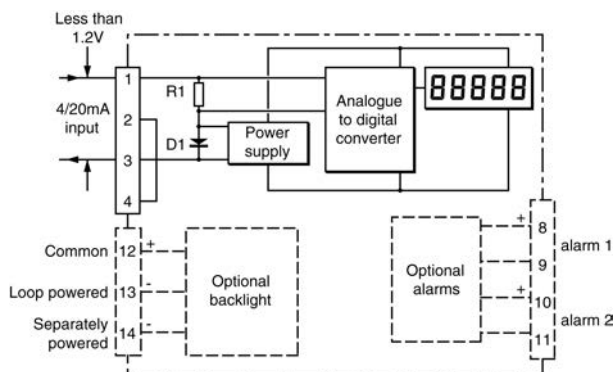

Fig 1 Indicator block diagram

2.1 Controls

The indicators are controlled and calibrated via four front panel push-buttons located below the display. In the display mode i.e. when the indicator is displaying a process variable, these push-buttons have the following functions:

- P** While this button is pushed the indicator will display the input current in mA, or as a percentage of the instrument span depending upon how the indicator has been conditioned. When the button is released the normal display in engineering units will return. The function of this push-button is modified when optional alarms are fitted to the indicator.
- ▼** While this button is pushed the indicator will display the numerical value and analogue bargraph* the indicator has been calibrated to display with a 4mA[Ⓟ] input. When released the normal display in engineering units will return.
- ▲** While this button is pushed the indicator will display the numerical value and analogue bargraph* the indicator has been calibrated to display with a 20mA[Ⓟ] input. When released the normal display in engineering units will return.
- E** No function in the display mode unless the tare function is being used.
- P + ▼** Firmware number followed by version.
- P + ▲** Direct access to the alarm setpoints when optional alarms are fitted to the indicator and the 'ACSP' access setpoints in display mode function has been enabled.
- P + E** Access to configuration menu via optional security code.

Note: * BA327E and BA328E only
[Ⓟ] If the indicator has been calibrated using the CAL function, calibration points may not be 4 and 20mA.

3. INTRINSIC SAFETY CERTIFICATION

All models have ATEX and IECEx gas and dust certification. This section of the instruction manual describes ATEX gas certification. ATEX dust and IECEx approvals are described in Appendixes 1 and 2.

3.1 ATEX gas certification

All the models have been issued with a common EC-Type Examination Certificate number ITS11ATEX27254X by Notified Body Intertek Testing and Certification Ltd. This confirms compliance with harmonised European standards and it has been used to confirm compliance with the European ATEX Directive for Group II, Category 1G equipment, Ex ia IIC T5 Ta = -40 to +70°C. The indicators bear the community mark and subject to local codes of practice may be installed in any of the European Economic Area (EEA) member countries. ATEX certificates are also acceptable for installations in Switzerland.

This section of the instruction manual describes ATEX installations in explosive gas atmospheres conforming with EN60079-14 Electrical Installations design, selection and erection. When designing systems for installation outside the UK the local Code of Practice should be consulted.

3.2 Zones, gas groups and T rating

The indicators have been certified Ex ia IIC T5. When connected to a suitable system the indicators may be installed in:

- Zone 0 explosive gas air mixture continuously present.
- Zone 1 explosive gas air mixture likely to occur in normal operation.
- Zone 2 explosive gas air mixture not likely to occur, and if it does will only exist for a short time.

Be used with gases in groups:

- Group A propane
- Group B ethylene
- Group C hydrogen

Having a temperature classification of:

- T1 450°C
- T2 300°C
- T3 200°C
- T4 135°C
- T5 100°C

At ambient temperatures between -40 and +70°C.

This allows the indicators to be installed in all gas Zones and with most common industrial gases.

3.3 Special conditions for safe use

The ATEX certificate has an 'X' suffix indicating that special conditions apply for safe use.

WARNING

To avoid an electrostatic charge being generated instrument enclosure should only be cleaned with a damp cloth.

3.4 4/20mA input

The input safety parameters for the 4/20mA input, terminals 1 and 3 are:

$$\begin{aligned} U_i &= 30\text{V dc} \\ I_i &= 200\text{mA} \\ P_i &= 0.84\text{W} \end{aligned}$$

The maximum equivalent capacitance and inductance between the two 4/20mA input terminals 1 and 3 is:

$$\begin{aligned} C_i &= 13\text{nF} \\ L_i &= 8\mu\text{H} \text{ (Effectively 0)} \end{aligned}$$

The maximum permitted loop cable parameters can be calculated by adding these figures to C_i and L_i of other instruments in the loop and subtracting the totals from the maximum cable capacitance C_o and cable inductance L_o permitted for the Zener barrier or galvanic isolator powering the loop.

Although the indicators do not themselves comply with the requirements for *simple apparatus*, the EC-Type Examination Certificate states that for intrinsic safety considerations, under fault conditions the output voltage, current and power at terminals 1 & 3 will not exceed those specified by clause 5.7 of EN 60079-11 for *simple apparatus*. This simplifies the application and intrinsic safety documentation for a loop into which an indicator is connected. Apart from C_i , the effect of the indicator's may be ignored when assessing the loop safety.

3.5 Certification label information

The certification label is fitted in a recess on the top outer surface of the instrument enclosure. It shows the ATEX certification information, instrument serial number, year of manufacture plus BEKA associates' name and location. Non European certification information may also be included, a typical label is shown below.



BA307E certification label

4. SYSTEM DESIGN FOR GAS HAZARDOUS AREAS

4.1 Transmitter loops

All indicator models may be connected in series with almost any intrinsically safe 4/20mA current loop and calibrated to display the measured variable or control signal in engineering units. There are three basic design requirements:

1. The intrinsic safety output parameters of the 4/20mA loop, which are defined by the Zener barrier or galvanic isolator powering the loop, must be equal to or less than:

$$\begin{aligned} U_o &= 30\text{V dc} \\ I_o &= 200\text{mA} \\ P_o &= 0.84\text{W} \end{aligned}$$

2. The maximum permitted cable capacitance of the loop must be reduced by 13nF. The maximum permitted cable inductance is not reduced by the inclusion of an indicator.
3. The loop must be able to tolerate the additional 1.2V required to operate the indicator. When fitted with an optional backlight this increases to 5.0V if the backlight is loop powered. See 9.4.1

Figs 2a and 2b illustrate typical applications in which an indicator is connected in series with a 2-wire transmitter powered by a Zener barrier and alternatively by a galvanic isolator.

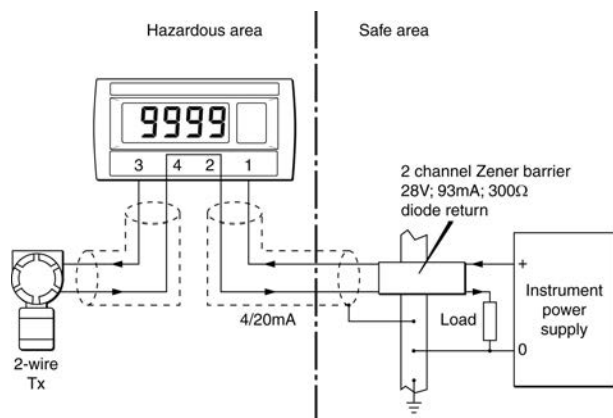

Fig 2a Loop powered by a Zener barrier

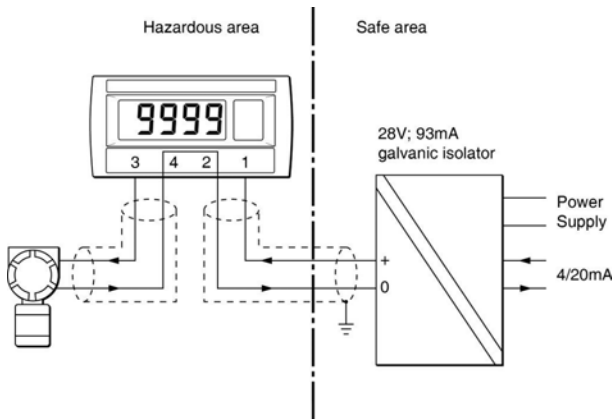

Fig 2b Loop powered by a galvanic isolator

4.2 Remote indication

The indicators may be driven via an intrinsically safe interface from a 4/20mA safe area signal to provide a remote display within a hazardous area. The type of intrinsically safe interface is not critical, either a Zener barrier or a galvanic isolator may be used, providing that U_i , L_i and P_i of the indicator are not exceeded and the voltage capability of the 4/20mA signal is sufficient to drive the indicator plus the interface.

When a high integrity earth connection is already available, a Zener barrier is usually the least expensive option. If an earth connection is not available or isolation is required, a galvanic isolator is the correct choice.

If one side of the 4/20mA current loop may be earthed, a single channel Zener barrier provides the lowest cost protection. If the 4/20mA signal is not isolated, then two Zener barriers, a two channel Zener barrier or a galvanic isolator must be used.

Fig 3 shows the alternative circuits which may be used.

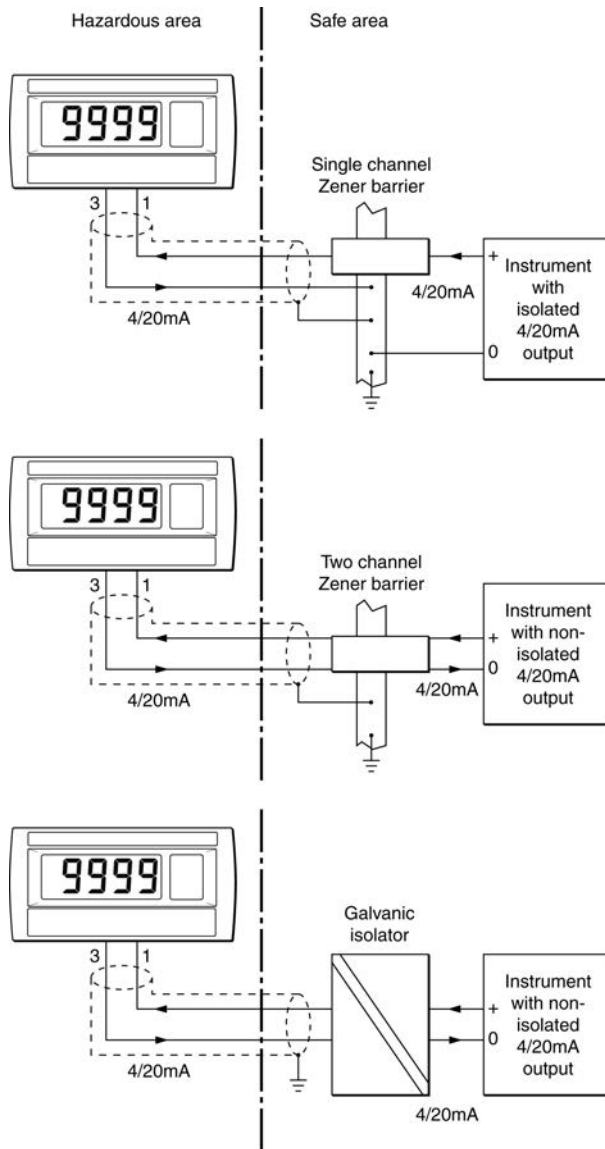

Fig 3 Alternative circuits for remote indication in a hazardous area

5. INSTALLATION

5.1 Location

All the models have a robust glass reinforced modified PPO enclosure with a toughened glass window. The front of the indicator has IP66 protection and a gasket seals the joint between the instrument enclosure and the panel. The rear of the indicator has IP20 protection.

The indicators may be installed in any panel providing that the operating temperature is between -40°C and +70°C and intrinsic safety requirements are complied with.

Figs 4A and 4B show the overall dimensions of the 96 x 48mm and the 144 x 72mm instruments together with the recommended panel cut-out dimensions. To achieve an IP66 seal between the instrument enclosure and the instrument panel the smaller tolerance aperture must be used, and the 144 x 72mm models must be secured with four panel mounting clamps.

Although the indicator front panel provides IP66 protection it should be shielded from direct sunlight and severe weather conditions.

Cut-out dimensions

Recommended for all installations.
Mandatory to achieve an IP66 seal between the instrument and the panel
90 +0.5/-0.0 x 43.5 +0.5/-0.0

DIN 43 700
92.0 +0.8/-0.0 x 45 +0.6 -0.0

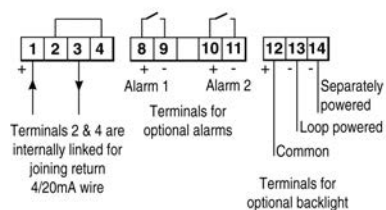
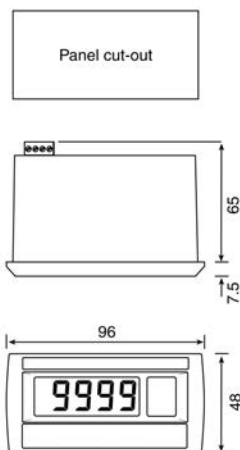

Fig 4A BA307E and BA327E dimensions

Cut-out dimensions

Recommended for all installations.
Mandatory to achieve an IP66 seal between the instrument and the panel
136 +0.5/-0.0 x 66.2 +0.5/-0.0

Note: Four panel mounting clamps required to achieve an IP66 seal

DIN 43 700
138.0 +1.0/-0.0 x 68 +0.7 -0.0

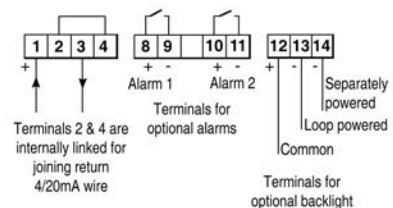
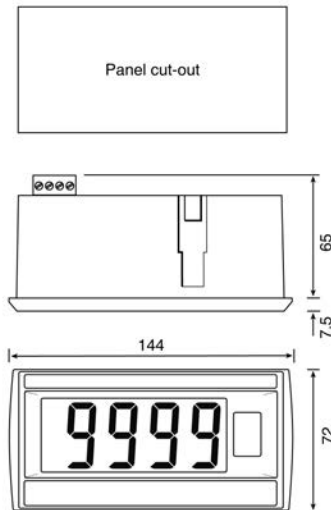

Fig 4B BA308E and BA328E dimensions

5.2 EMC

The indicators comply with the requirements of the European EMC Directive 2014/30/EU. For specified immunity all wiring should be in screened twisted pairs, with the screens earthed at one point within the safe area.

5.3 Installation Procedure

- Cut the specified aperture in the panel. To achieve an IP66 seal between the instrument enclosure and the instrument panel the aperture must have the tighter tolerances specified in Fig 4A and 4B.
- Slide the gasket over the body of the indicator before inserting the instrument into the panel aperture.
- Firstly ensure that all the panel mounting clamps are closed by turning the knurled screws fully anti clockwise until the two pips in the clamp foot align with holes in the clamp body.
- Place a clamp in the recess on each side of the indicator, pulling gently to slide it onto the dovetail as shown in Fig 5. Push the knurled screw slightly forward to engage the thread and tighten by turning clockwise until it is just finger tight. When both clamps are fitted ensure that the gasket behind the front panel bezel is correctly positioned before fully tightening the clamps to secure the instrument. The maximum recommended clamp tightening torque is 22cNm (1.95 lbf in) which is approximately equivalent to fingertight plus one half turn. **Do not over tighten.**
- Four panel mounting clamps are required to achieve an IP66 seal between a BA308E and BA328E indicator and the instrument panel.
- Connect the panel wiring to the rear terminal block(s) as shown in Figs 4A and 4B. To simplify installation, the terminals are removable so that the panel wiring can be completed before the instrument is installed.

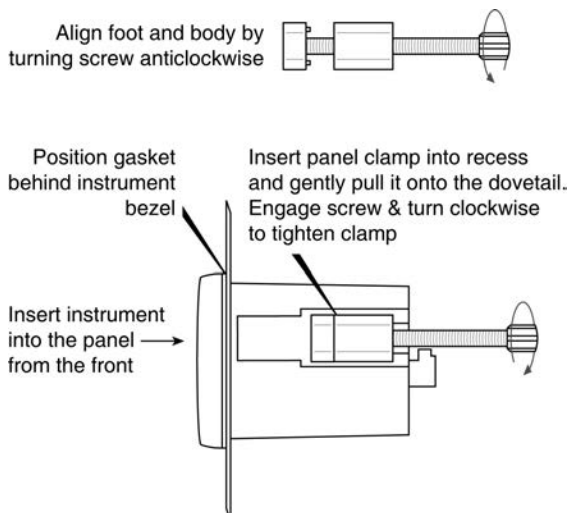

Fig 5 Fitting panel mounting clamps

5.4 Scale card

The indicator's units of measurement are shown on a printed scale card in a window at the right hand side of the display. The scale card is mounted on a flexible strip that is inserted into a slot at the rear of the instrument as shown in Fig 6. Thus the scale card can easily be changed without removing the indicator from the panel or opening the instrument enclosure.

New indicators are supplied with a printed scale card showing the requested units of measurement, if this information is not supplied when the indicator is ordered a blank card will be fitted.

A pack of self-adhesive scale cards printed with common units of measurement is available as an accessory from BEKA associates. Custom printed scale cards can also be supplied.

To change a scale card, unclip the protruding end of the flexible strip by gently pushing it upwards and pulling it out of the enclosure. Peel the existing scale card from the flexible strip and replace it with a new printed card, which should be aligned as shown below. Do not fit a new scale card on top of an existing card.

Install the new scale card by gently pushing the flexible strip into the slot at the rear of the indicator, when it reaches the internal end-stop secure it by pushing the end of the flexible strip downwards so that the tapered section is held by the rear panel.

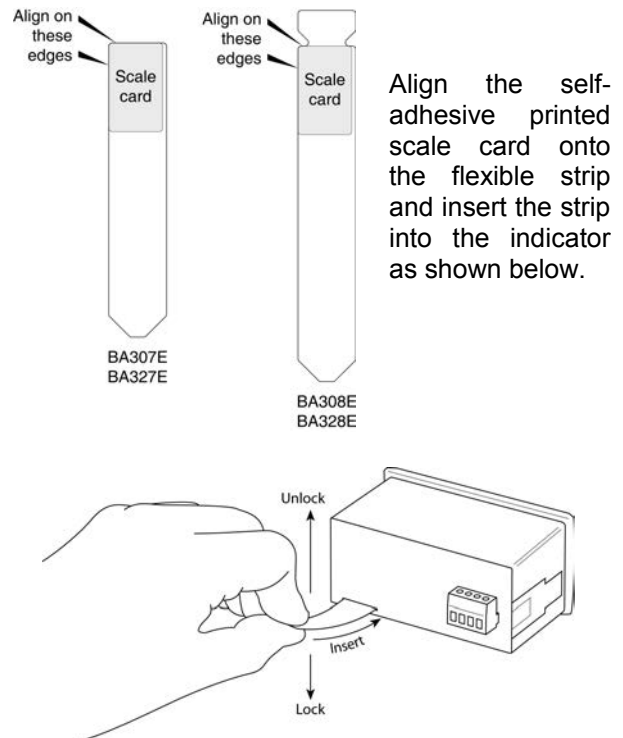

Fig 6 Inserting flexible strip carrying scale card into slot at the rear of indicator.

6. CONFIGURATION AND CALIBRATION

Indicators are configured and calibrated via the four front panel push-buttons. All the configuration functions are contained in an easy to use intuitive menu that is shown diagrammatically in Fig 7.

Each menu function is summarised in section 6.1 and includes a reference to more detailed information. When the indicator is fitted with alarms additional functions are added to the menu which are described in section 9.3

Throughout this manual push-buttons are shown as **P**, **E**, **▼** or **▲**, and legends displayed by the indicator are shown within inverted commas e.g. 'CAL' and 'ALr2'.

Access to the configuration menu is obtained by operating the **P** and **E** push-buttons simultaneously. If the indicator security code is set to the default 0000 the first parameter 'FunC' will be displayed. If a security code other than the default code 0000 has already been entered, the indicator will display 'CodE'. Pressing the **P** button will clear this prompt allowing each digit of the code to be entered using the **▲** and **▼** push-buttons and the **P** button to move control to the next digit. When the correct four digit code has been entered pressing **E** will cause the first parameter 'FunC' to be displayed. If the code is incorrect, or a button is not pressed within twenty seconds, the indicator will automatically return to the display mode.

Once within the configuration menu the required parameter can be reached by scrolling through the menu using the **▲** and **▼** push-buttons as shown in Fig 6. When returning to the display mode following recalibration or a change to any function, the indicator will display 'dAtA' followed by 'SAVE' while the new information is stored in non-volatile memory.

All new indicators are supplied calibrated as requested at the time of ordering. If calibration is not requested, indicators will be configured as follows:

	BA307E	BA327E
	BA308E	BA328E
Access code 'CodE'	0000	0000
Function 'FunC'	Std	Std
Display at 4mA 'Zero'	0.0	0.00
Display at 20mA 'SPAn'	100.0	100.00
Resolution 'rESn'	1 digit	1 digit
Bargraph start 'BarLo'	-----	0.00
Bargraph finish 'BarHi'	-----	100.00
P button in display mode 'C—P'	%	%
Tare 'tArE'	Off	Off

Default configuration can easily be changed on-site.

6.1 Summary of configuration functions

This section summarises each of the main configuration functions and includes a cross reference to a more detailed description. Fig 7 illustrates the location of each function within the configuration menu. The lineariser and the optional factory fitted alarms are described separately in sections 7 and 9.3 of this manual.

Display	Summary of function
'FunC'	<p>Indicator function Defines the relationship between the 4/20mA input current and the indicator display. May be set to:</p> <ul style="list-style-type: none"> 'Std' Standard linear relationship 'root' Square root extraction 'Lin' 16 segment adjustable lineariser – see section 7. <p>See section 6.2</p>
'rESn'	<p>Display resolution Defines the resolution of the least significant display digit. May be set to '1', '2', '5' or '10' digits. See section 6.3</p>
'dP'	<p>Decimal point Positions a dummy decimal point between any of the digits or turns it off. See section 6.4</p>
'CAL'	<p>Calibration of the digital display using an external current source. Enables the zero and span of the indicator to be adjusted using an external current source such as a calibrator. When used with an accurate traceable current source this is the preferred method of calibration. See section 6.5</p>
'SEt'	<p>Calibration of display using internal references. Enables the zero and span of the indicator to be adjusted without the need for an accurate input current or disconnection from the 4/20mA loop. See section 6.6</p>
'bAr'	<p>Bargraph format and calibration <i>Only BA327E & BA328E have bargraph</i> The bargraph may be conditioned to start from left, right or centre of the display, or it may be disabled. When optional alarms are fitted it can also display both alarm setpoints and the measured value. The bargraph may be calibrated to start and finish at any value within the indicator's calibrated digital display. See section 6.7</p>

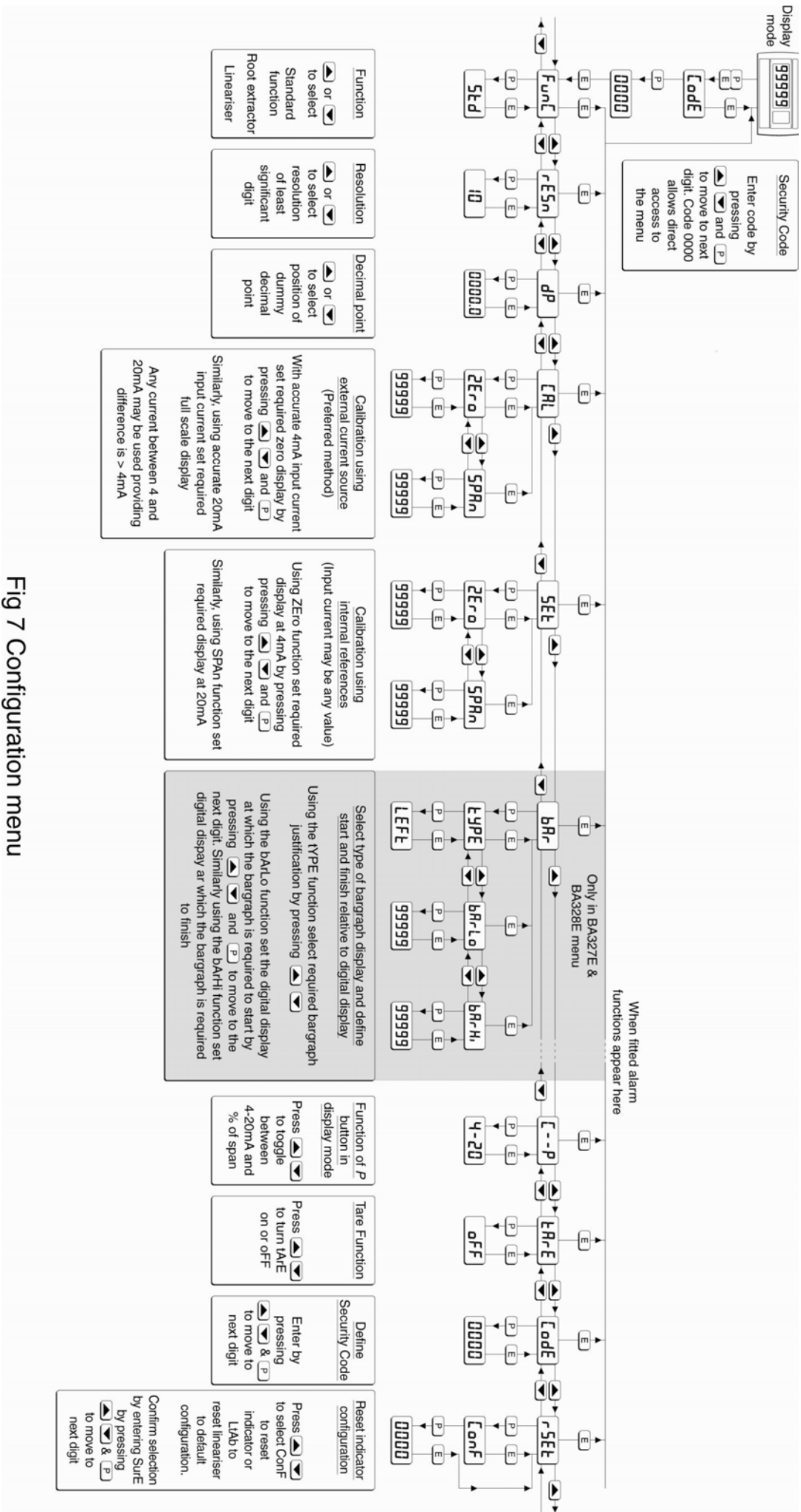

Fig 7 Configuration menu

Display	Summary of function
'C - - P'	<p>Function of P push-button The indicator may be configured to display the input current in milliamps, or the input current as a percentage of the 4/20mA input when the P push-button is operated in the display mode. See section 6.8</p>
'tArE'	<p>Tare function When enabled the tare function sets the indicator display to zero when the E push-button is operated in the display mode. See section 6.9</p>
'CodE'	<p>Security code Defines a four digit numeric code that must be entered to gain access to the configuration menu. Default code 0000 disables this security function and allows unrestricted access to all conditioning functions. See section 6.10</p>
'rSEt'	<p>Reset Contains two sub-functions, 'ConF' which returns the indicator to the default conditions and 'LtAb' which returns the lineariser to the default conditions. To prevent accidental use both resets must be confirmed by entering '5urE' before they will be executed. See section 6.11</p>

6.2 Indicator function: 'FunC'

This configuration function defines the relationship between the indicator's 4/20mA input current and the indicator's display. Three alternatives are available:

'Std'	Standard linear relationship
'root'	Square root extraction
'Lin'	16 segment adjustable lineariser.

To reveal the existing indicator function select 'FunC' from the configuration menu and press **P**. If the function is set as required, press **E** to return to the menu, or press the **▲** or **▼** button to change the setting, followed by the **E** button to return to the configuration menu.

'Std' Linear

Provides a linear relationship between the 4/20mA indicator input current and the indicator display.

'root' Square root extraction

Primarily intended to linearise the square law 4/20mA output from differential flowmeters.

For reference, the following table shows the output current from a non-linearised differential flowmeter.

% of full flow	Current output mA
2.5	4.01
10.0	4.16
25.0	5.00
50.0	8.00
75.0	13.00
100.0	20.00

When the root function is selected the indicator will display flow in linear units.

'Lin' 16 segment adjustable lineariser

Enables non linear variables to be displayed by the indicator in linear engineering units. Use of the lineariser is described in section 7 of this instruction manual.

6.3 Resolution: rESn

This function defines the resolution of the least significant display digit. Decreasing the display resolution can improve the readability of a noisy signal. Select 'rESn' from the menu and press **P** which will reveal the current display resolution. To change the resolution press the **▲** or **▼** button to select 1, 2, 5 or 10 digits, followed by the **E** button to enter the selection and return to the configuration menu.

6.4 Position of the decimal point: 'dP'

A dummy decimal point can be positioned between any of the digits or it may be absent. To position the decimal point select 'dP' from the menu and press **P**. The decimal point can be moved by pressing the **▲** or **▼** push-button. If a decimal point is not required it should be positioned beyond the most or least significant digit. When positioned as required press the **E** button to enter the selection and return to the configuration menu.

6.5 Calibration using an external current source: 'CAL'

This function enables the zero and span of the indicator to be adjusted using an external calibrated current source. When used with an accurate traceable current source this is the preferred method of calibration.

Zero is the indicator display with 4mA input
Span is the indicator display with 20mA input

To calibrate the indicator select 'CAL' from the configuration menu and press **P**. The indicator will display 'ZEro' which is a request for a 4mA input current. Adjust the external current calibrator to 4.000mA and again press **P** which will reveal the current zero display. The flashing digit of the indicator display can be changed by pressing the **▲** or **▼** buttons, when set as required pressing **P** will transfer control to the next digit. When all the digits have been adjusted, press **E** to enter the new zero and return to the 'ZEro' prompt.

Pressing the **▲** button will cause the indicator to display 'SPAn' which is a request for a 20mA input current. Adjust the external current calibrator to 20.000mA and again press **P** which will reveal the existing span display. The flashing digit of the indicator display can be changed by pressing the **▲** or **▼** buttons, when set as required pressing **P** will transfer control to the next digit. When all the digits have been adjusted press **E** to enter the new span and return to the 'SPAn' prompt. Finally press **E** again to return to the configuration menu.

Notes:

- The indicator input current must be adjusted to the required value before the zero and span functions are entered by pressing the **P** button.
- Indicators may be calibrated at currents other than 4 and 20mA, within the range 3.8 to 21.0mA providing the difference between the two currents is greater than 4mA. If these conditions are not complied with, the indicator displays 'Fail' and aborts the calibration.
- If the zero current is greater than the span current the instrument will be reverse acting i.e. an increasing input current will cause the display to decrease.

6.6 Calibration using internal reference: 'SEt'

Using the 'SEt' function the indicator can be calibrated without the need for an accurate external current source and without the need to disconnect the indicator from the 4/20mA measuring loop.

The indicator's internal reference is used to simulate a 4mA and 20mA input current, so the actual indicator input current does not have to be known during calibration.

Zero is the display with a simulated 4mA input
Span is the display with a simulated 20mA input

To calibrate the indicator display select 'SEt' from the configuration menu and press **P**. The indicator will display 'ZEro', pressing **P** again will reveal the current display at 4mA. The flashing digit can be adjusted by pressing the **▲** or **▼** buttons, when the flashing digit is correct pressing **P** will transfer control to the next digit. When all the digits have been adjusted, press **E** to return to the 'ZEro' prompt.

To adjust the display at 20mA, press the **▲** button which will cause the indicator to display 'SPAn', pressing **P** will then reveal the indicator's existing display at 20mA. The flashing digit can be adjusted by pressing the **▲** or **▼** buttons, when the flashing digit is correct pressing **P** will transfer control to the next digit. When all the digits have been adjusted press **E** to return to the 'SPAn' prompt followed by **E** to return to the 'SEt' prompt in the configuration menu.

6.7 Bargraph format and calibration: 'bAr'

Only BA327E & BA328E have a bargraph

In addition to a five digit numerical display the two BA327E and BA328E indicators have a 31 segment analogue bargraph which may be configured to start and finish anywhere within the indicators numerical display range.

To configure the bargraph select 'bAr' from the configuration menu and press **P**. The indicator will display 'tYPE', pressing **P** again will reveal the existing bargraph justification which can be changed to one of the following four or five options using the **▲** or **▼** button:

	Bargraph starts from
'LEFT'	Left end of display
'CEnt'	Centre of display
'riGHt'	Right end of display
'AlrSP'	Only with alarms – see section 9.3.14
'oFF'	Bargraph disabled

When set as required press **E** to return to the 'tYPE' sub-function prompt.

The indicator's digital display at which the bargraph starts is defined by the 'bArLo' sub-function which is selected by pressing the ▲ button followed by the **P** button which will reveal the current indicator display at which the bargraph starts. The flashing digit can be adjusted by pressing the ▲ or ▼ buttons, when set as required pressing **P** will transfer control to the next digit. When all the digits have been adjusted, press **E** to return to the 'bArLo' prompt from which 'bArHi' which defines the finishing point of the bargraph can be selected by pressing the ▲ button. 'bArHi' is adjusted in the same way as 'bArLo'. When set as required, pressing **E** twice will return the display to the 'bAr' prompt in the configuration menu.

Note: 'bArLo' must be set lower than 'bArHi', incorrect setting is indicated by the bargraph scale flashing with a single bargraph segment activated.

6.8 Function of the **P** push-button: 'C - - P'

When the indicator is in the display mode, operating the **P** push-button will display the input current in milliamps, or the displayed value as a percentage of the difference between the displayed values at 4mA and 20mA inputs.

To check or change the function of the **P** push-button select 'C - -P' from the configuration menu and press **P** to reveal the current setting. Pressing the ▲ or ▼ button will toggle the setting between '4-20' the current display in milliamps and 'PC' the percentage display. When set as required press **E** to return to the 'C - - P' prompt in the configuration menu.

6.9 Tare function: 'tArE'

The tare function is primarily intended for use with weighing system. When the indicator is in the display mode and the tare function is activated, pressing the **E** button for more than three seconds will zero the indicator's digital display and activate the tare annunciator. On models with a bargraph, the bargraph remains linked to the digital display when the tare function is activated. Subsequent operation of the **E** push-button for less than 3 seconds will return the indicator to the gross display and deactivate the tare annunciator.

To check or change the tare function select 'tARE' from the configuration menu and press **P** to reveal the current setting. Pressing the ▲ or ▼ button will toggle the setting between 'on' and 'off'. When set as required press **E** to return to the 'tARE' prompt in the configuration menu.

6.10 Security code: 'CodE'

Access to the instrument configuration menu may be protected by a four digit security code which must be entered to gain access. New instruments

are configured with the default security code 0000 which allows unrestricted access to all configuration functions.

To enter a new security code select 'CodE' from the configuration menu and press **P** which will cause the indicator to display the existing security code with one digit flashing. The flashing digit can be adjusted using the ▲ and ▼ push-buttons, when set as required operating the **P** button will transfer control to the next digit. When all the digits have been adjusted press **E** to return to the 'CodE' prompt. The revised security code will be activated when the indicator is returned to the display mode. Please contact BEKA associates sales department if the security code is lost.

6.11 Reset to factory defaults: 'rSET'

This function enables the indicator and the lineariser to be quickly returned to the factory default configurations shown in sections 6 and 7.

To reset the indicator or lineariser select 'rSET' from the configuration menu and press **P**, the indicator will display one of the reset options 'ConF' or 'LtAb'.

'ConF'	Resets the indicator to defaults
'LtAb'	Resets the lineariser to defaults

Using the ▲ or ▼ push-button select the required sub-function and press **P**. To prevent accidental resetting the request must be confirmed by entering '5urE'. Using the ▲ button set the first flashing digit to '5' and press **P** to transfer control to the second digit which should be set to 'u'. When '5urE' has been entered pressing the **E** button will reset the selected configuration menus and return the display to the 'rSET' function in the configuration menu.

6.12 Under and over-range

If the numerical display range of the indicator is exceeded, all the decimal points will flash as shown below:

	BA307E	BA327E
	BA308E	BA328E
Underrange	-9.9.9.9	-9.9.9.9.9
Overrange	9.9.9.9	9.9.9.9.9

Although not guaranteed, most indicators will continue to function normally with an input current between 1.8mA and 4mA, at lower currents the instrument will display 'LPLo' before it stops functioning.

Under or overrange of the BA327E and BA328E bargraph is indicated by a flashing arrow at the appropriate end of the bargraph.

7. LINEARISER

A sixteen segment, seventeen break-point (0 to 16) lineariser may be selected in the 'FunC' section of the configuration menu. The position of each break-point is fully adjustable so that the slope of the straight line between break-points can be set to compensate for input non-linearity, thus allowing the indicator to display a non-linear process variables in linear engineering units. Each break-point must occur at a current greater than the preceding break-point and less than the following break-point, in the range 3.8 to 21.0mA. If this requirement is not observed when configuring the lineariser the indicator will display 'Fail' and the configuration adjustment which produced the error message will be ignored. Fig 8 shows a typical linearised indicator characteristic.

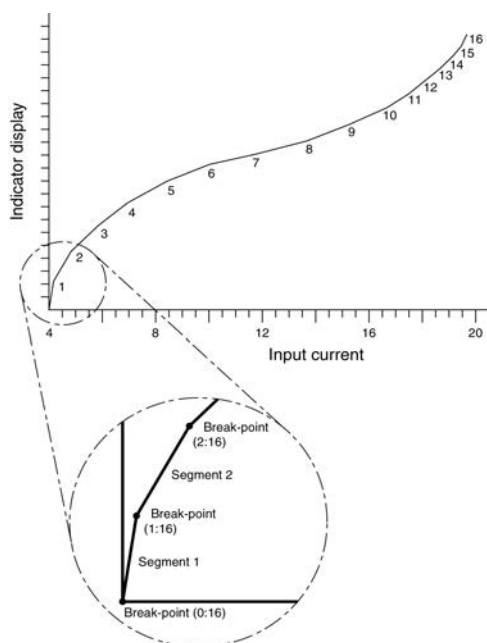

Fig 8 shows a typical linearising characteristic

Selecting 'Lin' in the 'FunC' section of the configuration menu activates the lineariser, this does not change the configuration menu shown in Fig 7, but the 'CAL' and 'SEt' functions are extended as shown in Fig 9. As with a linear indicator, calibration of the lineariser may be performed with an external current source using the 'CAL' function, or with the internal reference using the 'SEt' function.

The lineariser calibration is retained irrespective of how the indicator function 'FunC' is subsequently changed. It is therefore possible to select and deselect the lineariser without having to reconfigure it each time.

The lineariser calibration may be reset to the factory default settings without changing the indicator configure using the 'LtAb' function described in section 6.11.

7.1 Lineariser calibration using an external current source.

This method allows direct calibration of the lineariser with an external current source and is the preferred method when traceability is required. If the exact system non-linearity is unknown, this method also allows direct calibration from the variable to be displayed. e.g. the output from a level sensor in an irregular tank may be displayed in linear volumetric units by filling the tank with known incremental volumes and calibrating the indicator to display the sum of the increments at each break-point.

The number of break-point required should first be entered using the 'Add' and 'dEL' functions. In both these sub-functions the indicator initially displays the current break-point and the total number of break-points being used as shown below.



Display Description of function

'Add' Add a break-point

Adds a new break-point before the displayed break-point. The calibration of existing break-points is not changed, but the identification number of all subsequent break-points is increased by one.

'dEL' Remove a break-point

Removes the displayed break-point and joins the preceding break-point to the following break-point with a straight line. The identification number of all subsequent break-points is decreased by one.

To add a break-point use the ▲ or ▼ button to select 'CAL' from the configuration menu and press **P** which will result in the 'Add' sub-function prompt being displayed. To enter the sub-function press **P** which will reveal the current break-point and the total number of break-points which have already been entered. When adding a break-point the insertion position can be selected using the ▲ and ▼ push buttons followed by **P** push button to insert the additional break-point. In previously uncalibrated linearisers each new break-point should be added in front of the highest existing break-point, if this sequence is not followed a 'Fail' message will occur in the 'Pt5' function. See example in section 7.1.1.

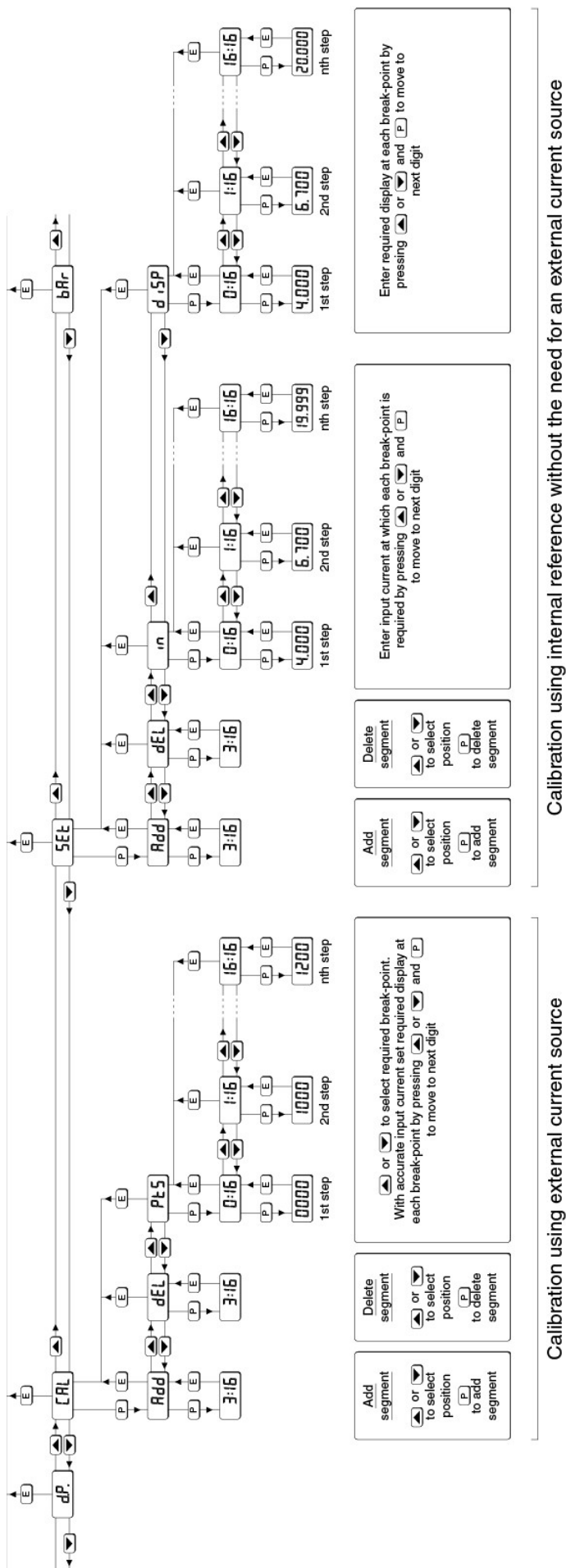

Calibration using internal reference without the need for an external current source

Calibration using external current source

Each break-point must occur at an input current greater than the preceding break-point and less than the following break-point, in the range 3.8 to 21.0 mA

Fig 9 Extension of CAL and SET functions for lineariser configuration

The delete break-point sub-function 'dEL' operates in exactly the same way as the 'Add' sub-function described above. Once within the 'dEL' sub-function each time the **P** button is pressed a break-point is removed. When deleting a break-point from a calibrated indicator, the break-point to be deleted can be selected using the **▲** and **▼** push buttons. The minimum number of break-point is 2, break-points '0:1' and '1:1'.

When the required number of linearising break-points has been entered, return to the linearisation sub-menu by pressing **E**. The indicator will display the 'Add' or 'dEL' prompt depending upon the last function used. Using the 'Pts' sub-function the input current at which each break-point occurs and the corresponding indicator display may now be defined.

Using the **▲** or **▼** button select the 'Pts' function in the sub-menu and press **P** to enter the function which will display the first break-point '0:n', where n is the total number of linearising break-points entered – see Fig 8. The selected linearising break-point can be changed using the **▲** and **▼** buttons. When the required linearising break-point has been selected set the indicator input current to the exact value at which the break-point is required and press **P***. Using the **▲** and **▼** buttons and the **P** button to move between digits, enter the required indicator display at this break-point. When set as required, press the **E** push button to enter the required indicator display and return to the sub-menu from which the next break-point can be selected.

When all the break-points have been calibrated pressing **E** twice will return the indicator to the 'CAL' function in the configuration menu.

Note: * The indicator input current must be adjusted to the required value before the **P** button is operated to enter the required indicator display.

Error message

If during calibration the indicator displays a 'FAiL' error message the current at which the selected break-point is being set is not above the proceeding break-point or is not below the following break-point.

7.1.1 Example

Adding break-points to a new indicator

When adding break-points to a new indicator, or to a lineariser following resetting to the factory defaults using the 'LTab' function described in section 6.11, each additional break-point should be added before the highest existing breakpoint. The first additional break-point should be added before the default break-point '1:1' which will result

in a display of '1:2'. If more new break-points are required, using the **▲** button select the new highest break-point '2:2' and add the second additional break-point by operating the **P** push button which will result in a display of '2:3'. Repeat the sequence until the required number of break-points has been entered.

The input current and at which each break-point occurs and the corresponding indicator display may now be entered as described above.

7.2 Lineariser calibration using the internal reference.

The 'SEt' function enables the lineariser to be calibrated without the need for an accurate external current source. Throughout the calibration the indicator input current may be any value between 4 and 20mA.

The 'SEt' functions contains four sub-functions.

Display	Description of function
'Add'	Add a break-point Adds a new break-point before the displayed break-point. The calibration of existing break-points is not changed, but the identification number of all subsequent break-point is increased by one.
'dEL'	Remove a break-point Removes the displayed break-point and joins the preceding segment to the following segment with a straight line. The identification number of all subsequent break-points is decreased by one.
'in'	Defines the current at which break-point occurs. Enables the required current at each break-point to be defined without having to input an accurate input current to the indicator.
'diSP'	Defines indicator display at break-point. Enables the indicator display at each break-point to be defined.

The number of break-point required should first be entered using the 'Add' and 'dEL' sub-functions. In both these sub-functions the indicator initially displays the current break-point and the total number of break-point being used as shown below.



current breakpoint total number of breakpoints

To add a break-point using the ▲ or ▼ button select 'SEt' from the configuration menu and press **P** which will result in the 'Add' sub-function prompt being displayed. To enter the sub-function press **P** which will reveal the current break-point and the total number of break-points which have already been entered. When adding a break-point the insertion position can be selected using the ▲ and ▼ push buttons followed by **P** push button to insert the additional break-point. In previously uncalibrated linearisers each new break-point should be added in front of the highest existing break-point, if this sequence is not followed a 'Fail' message will occur when the break-points are calibrated. See example in section 7.2.1.

The delete break-point, sub-function 'dEL' operates in exactly the same way as the 'Add' sub-function described above. Once within the 'dEL' function each time the **P** button is pressed a break-point is removed. When deleting a break-point from a calibrated indicator, the break-point to be deleted can be selected using the ▲ and ▼ push buttons. The minimum number of break-point is 2, break-points '0:1' and '1:1'.

When the required number of linearising break-point has been entered, return to the linearisation sub-menu by pressing **E**. The indicator will display the 'Add' or 'dEL' prompt depending upon the last sub-function used. The indicator input current and corresponding indicator display at each break-point, which is the segment finishing point as shown in Fig 8, can now be entered using the 'in' and 'diSP' sub-functions.

Using the ▲ or ▼ button select 'in' from the sub-menu and press **P** which will reveal the starting point for the first segment '0:n', where n is the total number of break-point entered. Press **P** and use the ▲ and ▼ buttons and the **P** button to move between digits, to enter the input current in milliamps at which the first break-point is required, usually 4.000mA. When set as required, press **E** to return to the '0:n' prompt from which the next break-point can be selected using the ▲ and ▼ buttons. When the required break-point has been selected press **P** and enter the indicator input current at which this break-point is required using the ▲ and ▼ buttons and the **P** button to move between digits,. Repeat this procedure until the indicator input current at all the break-points has been defined and then return to the 'in' sub-function by pressing the **E** button.

The corresponding indicator display at each of the break-points can now be defined using the 'diSP' sub-function. Using the ▲ and ▼ buttons select the 'diSP' sub-function and press **P** which will reveal the starting point for the first break-point '0:n', where n is the total number of break-points entered. Press **P** and use the ▲ and ▼ buttons

and the **P** button to move between digits, to enter the required indicator display at the first break-point. When set as required, press **E** to return to the '0:n' prompt from which the next break-point can be selected using the ▲ or ▼ buttons. When the required break-point has been selected press **P** and set the required indicator display at this break-point.

Repeat this procedure until the indicator display at all the break-points has been defined and then return to the 'SEt' function in the configuration menu by pressing the **E** button twice.

Error message

If during calibration the indicator displays a 'FAiL' error message the current at which the selected break-point is being set is not above the preceding break-point or is not below the following break-point.

7.2.1 Example

Adding break-points to a new indicator

When adding break-points to a new indicator, or to a lineariser following resetting to the factory defaults using the 'LAb' function described in section 6.11, each additional break-point should be added before the highest existing breakpoint. The first additional break-point should be added before the default break-point '1:1' which will result in a display of '1:2'. If more new break-points are required, using the ▲ button select the new highest break-point '2:2' and add the second additional break-point by operating the **P** push button which will result in a display of '2:3'. Repeat the sequence until the required number of break-points has been entered.

7.3 Under and over-range

The lineariser does not change the under and over-range indication described in section 6.12. At input currents below that specified for the first break-point '0:n', the indicator will continue to use the specified slope of the first segment.

At input currents above that specified for the last break-point 'n:n', the indicator will continue to use the slope specified for the last lineariser segment.

7.4 Lineariser default configuration

When the lineariser is reset to the factory defaults using the 'LAb' function described in section 6.11, the defaults conditions are:

		Indicator display	
		BA307E	BA327E
		BA308E	BA328E
First break-point	'0:1' 4mA	0.0	0.00
Second break-point	'1:1' 20mA	100.0	100.00

8. MAINTENANCE

8.1 Fault finding during commissioning

If an indicator fails to function during commissioning the following procedure should be followed:

Symptom	Cause	Solution
No display	Incorrect wiring	Check wiring There should be 0.6 to 1.2V between terminals 1 & 3 with terminal 1 positive. With an optional loop powered backlight, there should be 3.4 to 5V between terminals 3 & 12 with terminal 12 positive.
No display 0V between terminals 1 & 3.	Incorrect wiring or no power supply	Check supply voltage and voltage drop caused by all the instruments in the loop.
All decimal points flashing.	Underrange if -ve sign displayed or overrange.	Recalibrate the numerical display.
Unstable display	4/20mA input is noisy.	Eliminate ripple on 4/20mA power supply and/or decrease indicator resolution.
Unable to enter configuration menu.	Incorrect security code entered.	Enter correct security code, or contact BEKA if the code has been lost.

8.2 Fault finding after commissioning

ENSURE PLANT SAFETY BEFORE STARTING MAINTENANCE

Live maintenance is permitted on intrinsically safe equipment installed in a hazardous area, but only certified test equipment should be used unless a gas clearance certificate is available.

If an indicator fails after it has been functioning correctly follow the procedure shown in section 8.1. If this does not reveal the cause of the fault, it is recommended that the instrument is replaced. This can be done without disconnecting power, but while the indicator is disconnected the 4/20mA loop will be open circuit.

8.3 Servicing

All BA307E, BA327E, BA308E and BA328E loop powered indicators are interchangeable if the required optional backlight and alarms are fitted. A single spare instrument may quickly be recalibrated to replace any instrument that is damaged or fails. No attempt should be made to repair instruments at component level.

We recommend that faulty instruments are returned to BEKA associates or to your local BEKA agent for repair.

8.4 Routine maintenance

The mechanical condition of the instrument and electrical calibration should be regularly checked. The interval between inspections depends upon environmental conditions. We recommend that initially instrument calibration should be checked annually.

8.5 Guarantee

Indicators which fail within the guarantee period should be returned to BEKA associates or our local agent. It is helpful if a brief description of the fault symptoms is provided.

8.6 Customer comments

BEKA associates is always pleased to receive comments from customers about our products and services. All communications are acknowledged and whenever possible, suggestions are implemented.

9. ACCESSORIES

9.1 Scale card

All models have a window on the right hand side of the display through which to view a scale card showing the units of measurement such as °C, mBar, RPM. New indicators are fitted with a scale card showing the units of measurement specified when the indicator was ordered, if the units are not specified a blank scale card will be fitted. A pack of scale cards pre-printed with common units of measurement is available as an accessory. These can easily be fitted on-site to the indicator without opening the indicator enclosure or removing it from the panel, See section 5.3 of this instruction manual.

Custom scale cards for applications requiring less common units of measurement are also available.

9.2 Tag information

New indicators are supplied with tag or application information thermally printed onto the rear panel adjacent to the terminals, legend as specified when the indicator was ordered. This tag information is not visible from the front of the instrument after installation.

9.3 Alarms

CAUTION

These alarms outputs should not be used for critical safety applications such as an emergency shut down system.

All models can be supplied with factory fitted dual solid state, single pole alarm outputs. Each alarm output may be independently conditioned as a high or low alarm with a normally open or normally closed output in the non-alarm condition.

When the 4/20mA current powering the indicator is removed both alarm outputs will open irrespective of configuration. The open circuit condition should therefore be chosen as the alarm condition when designing an alarm system. Fig 10 illustrates the conditions available and shows which are fail safe.

When an alarm occurs an alarm annunciator on the indicator front panel is activated and if required the numerical display can alternate between the measured value and the alarm channel identification 'ALr1' or 'ALr2'.

CAUTION

The alarms are activated by the indicator's numerical display. Use of the Tare Function 'tArE' will change the numerical display, the alarms will continue to function at the original displayed value, but this will correspond to a different input current.

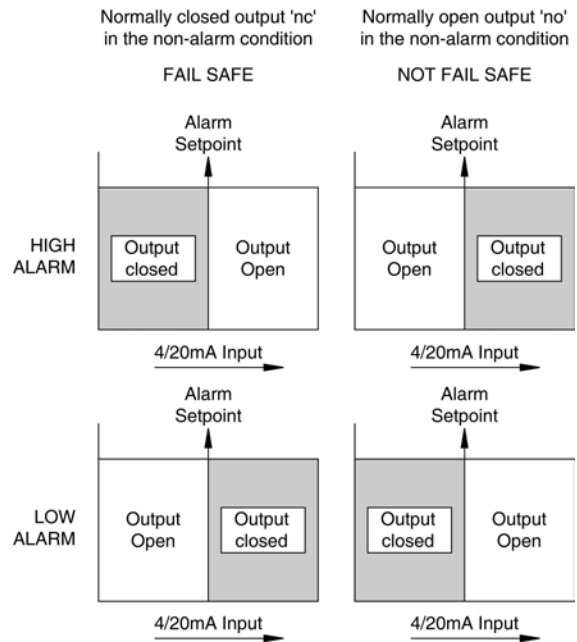

Fig 10 Alarm outputs

Configurable functions for each alarm include adjustable setpoint, hysteresis, alarm delay and alarm accept.

9.3.1 Solid state output

Each alarm has a galvanically isolated single pole solid state switch output which as shown in Fig 11. The output is polarised and current will only flow in one direction.

$$R_{on} = \text{less than } 5\Omega + 0.7V$$

$$R_{off} = \text{greater than } 1M\Omega$$

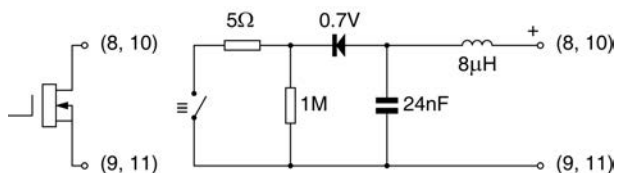

Fig 11 Equivalent circuit of each alarm output

9.3.2 Intrinsic safety

Each alarm output is a separate galvanically isolated intrinsically safe circuit with output safety parameters complying with the requirements for *simple apparatus*. This allows the alarm output terminals 8 & 9 and 10 & 11 to be connected to almost any intrinsically safe circuit protected by a Zener barrier or galvanic isolator providing the output parameters of the circuit do not exceed:

$$U_o = 30V \text{ dc}$$

$$I_o = 200mA$$

$$P_o = 0.84W$$

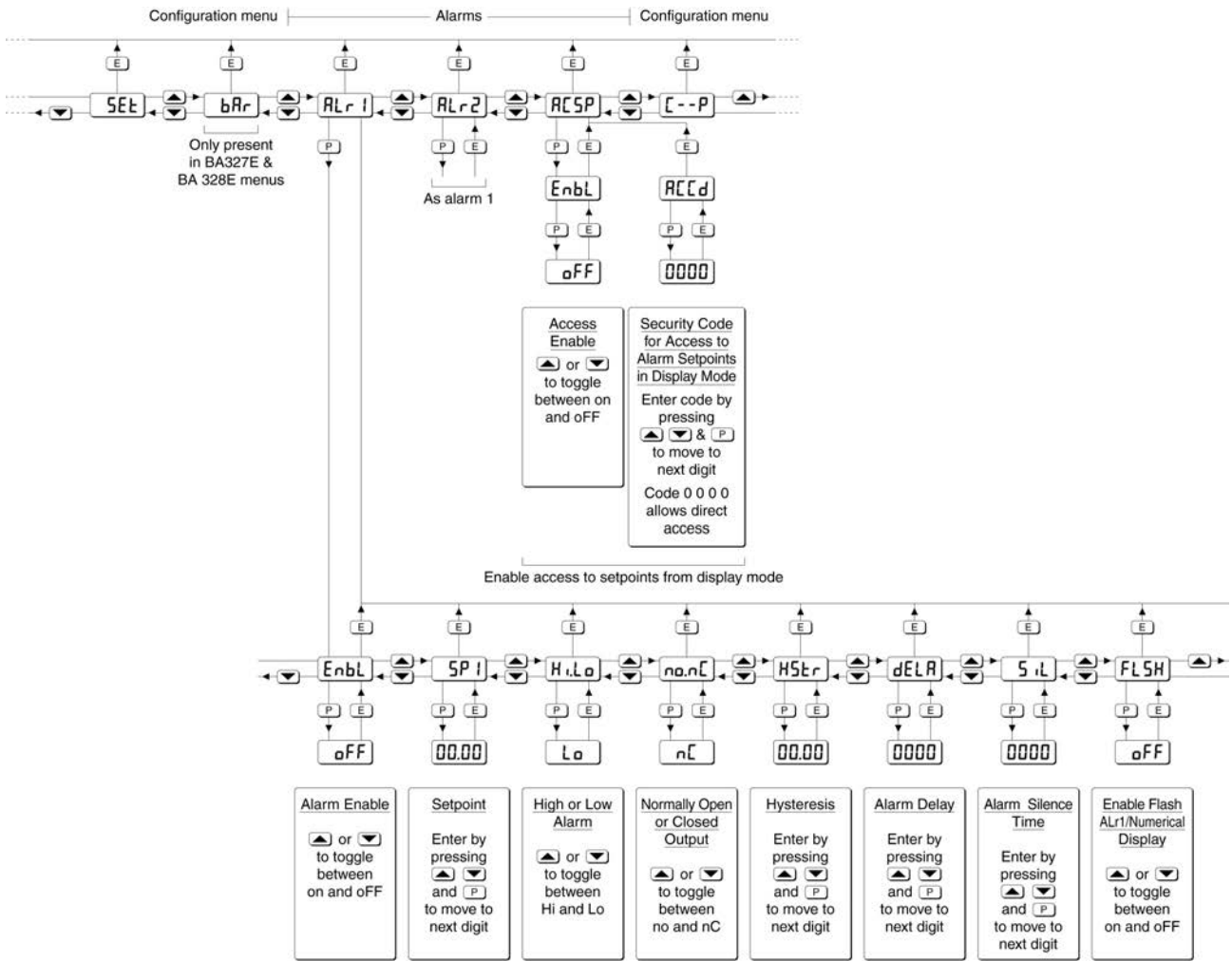

Fig 12 Alarm Configuration Functions in Configuration Menu

The maximum equivalent capacitance and inductance between each set of alarm terminals is:

$$C_i = 24\text{nF}$$

$$L_i = 8\mu\text{H (Effectively 0)}$$

To determine the maximum permissible cable parameters C_i should be subtracted from the maximum permitted cable capacitance specified by the certificate powering the alarm circuit, such as the solenoid driver and switch transfer galvanic isolators shown in Fig 13.

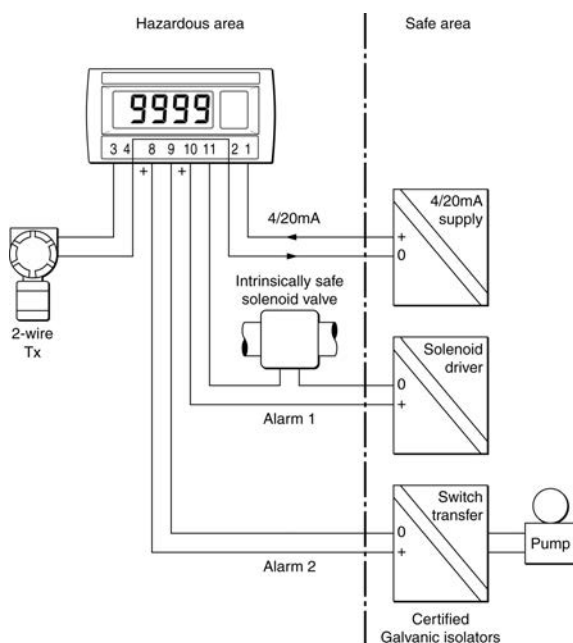

Fig 13 Typical alarm application
(Shown without recommended screen cables)

9.3.3 Configuration and adjustment

When optional alarms are fitted to a loop powered indicator the configuration menu is extended as shown in Fig 12. The additional functions appear between the 'SEt' and the 'C- - P' functions for the BA307E and BA308E indicators, and between 'bAr' and 'C- -P' for the BA327E and BA328E indicators. For simplicity, Fig 12 only shows the additional functions for alarm 1, but alarm 2 has identical functions.

The following table summaries each of the alarm configuration functions and includes a cross reference to more detailed information. Again only the functions on alarm 1 are listed, but alarm 2 has identical facilities.

Summary of alarm configuration functions

Display	Description of function
'EnbL'	Alarm enable Enables or disables the alarm without changing the alarm parameters. See section 9.3.4
'SP1'	Alarm setpoint 1 Adjusts the alarm setpoint. The alarm is activated when the indicator display equals the setpoint. See section 9.3.5
'Hi.Lo'	Alarm function Defines the alarm function as High or Low. See section 9.3.6
'no.nC'	Normally open or normally closed output Sets the alarm output open or closed in the non-alarm condition. See section 9.3.7
'HStr'	Hysteresis Adjusts the alarm hysteresis. See section 9.3.8
'dELA'	Alarm delay time Introduces adjustable delay between the display equalling the setpoint and the alarm output being activated. See section 9.3.9
'SiL'	Alarm silence time Defines the time that the alarm output remains in the non-alarm condition following acceptance of an alarm. See section 9.3.10
'FLSH'	Flash display when alarm occurs When enabled, alternates the numerical display between process value and alarm reference, 'ALr1' or 'ALr2', when an alarm output is activated. See section 9.3.11
'ACSP'	Access setpoint Sub-menu which enables direct access to the alarm setpoints from the indicator display mode, and defines a separate security code. See section 9.3.12

9.3.4 Alarm enable: 'EnbL'

This function allows each alarm to be enabled or disabled without altering any of the alarm parameters. To enable or disable the alarm select 'EnbL' from the alarm menu and press **P** which will reveal the current setting 'on' or 'oFF'. The function can be changed by pressing the **▲** or **▼** button followed by the **E** button to return to the alarm menu.

9.3.5 Setpoint adjustment: 'SP1' and 'SP2'

The setpoint of each alarm may be positioned anywhere in the numerical display of the indicator providing that this corresponds to an input current between 3.8 and 20.2mA. e.g. If the indicator has been calibrated to display 0 with 4mA input and 10000 with 20mA input, the two alarm setpoints may be positioned anywhere between -125 and 10125.

To adjust the setpoint select 'SP1' or 'SP2' from the alarm configuration menu and press **P** which will reveal the existing alarm setpoint. The flashing digit of the setpoint can be adjusted using the **▲** and **▼** push-buttons, and the **P** button to move control to the next digit. When the required setpoint has been entered press **E** to return to the alarm configuration menu.

The alarm setpoints may also be adjusted when the indicator is in the display mode, see section 9.3.12.

9.3.6 Alarm function: 'Hi.Lo'

Each alarm can be independently conditioned as a high alarm or as a low alarm. To check or change the alarm function select 'Hi.Lo' from the alarm menu and press **P** to reveal the current setting. The function can be changed by pressing the **▲** or **▼** button followed by the **E** button to return to the alarm menu.

9.3.7 Alarm output status: 'no.nC'

Configures the solid state alarm output to be open 'no' or to be closed 'nC' in the non-alarm condition. When deciding which is required, care should be taken to ensure that the alarm output is fail safe as illustrated in Fig 10.

'no' Alarm output open in non-alarm condition

'nC' Alarm output closed in non-alarm condition

CAUTION

When the 4/20mA supply is removed from the loop powered indicator, both alarm outputs will open irrespective of conditioning. Therefore for fail safe operation both alarm outputs should be conditioned to be open in the alarm condition 'nC'.

To check or change the alarm output status, select 'no.nC' from the alarm configuration menu and press **P** to reveal the setting. The function may be changed by pressing the **▲** or **▼** button followed by the **E** button to return to the alarm configuration menu.

9.3.8 Hysteresis: HStr

Hysteresis is shown in the units that the indicator has been calibrated to display.

To adjust the hysteresis select 'HStr' from the alarm menu and press **P** which will reveal the existing figure. The flashing digit can be adjusted using the **▲** and **▼** push-buttons, and the **P** button will move control to the next digit. When the required hysteresis has been entered press **E** to return to the alarm configuration menu.

e.g. An indicator calibrated to display 0 to 10000, with a high alarm set at 9000 and hysteresis of 200 will perform as follows:

The high alarm will be activated when increasing indicator display equals 9000, but will not reset until the indicator display falls below 8800.

9.3.9 Alarm delay: dELA

This function delays activation of the alarm output for an adjustable time following the alarm condition occurring. The delay can be set in 1 second increments between 0 and 3600 seconds. If a delay is not required zero should be entered. To adjust the delay select 'dELA' from the alarm configuration menu and press **P** which will reveal the existing delay. The flashing digit of the delay can be adjusted using the **▲** and **▼** push-buttons, and the **P** button to move control to the other digits. When the required delay has been entered press **E** to return to the alarm menu.

e.g. An indicator with a high alarm set at 9000 and an alarm delay of 30 seconds will perform as follows:

The alarm annunciator will start to flash when an increasing indicator display equals 9000, but the alarm output will not be activated until the alarm condition has existed continuously for 30 seconds. When the alarm output is activated, the alarm annunciator will stop flashing and become permanently activated.

If the 'FLSH' function, which flashes the indicator display when an alarm occurs, has been enabled, it will not start to function until the alarm output is activated.

See section 9.3.11

9.3.10 Alarm silence time: SiL

This function is primarily intended for use in small installations where the alarm output directly operates an alarm annunciator such as a sounder or beacon. When the alarm silence time, which is adjustable between 0 and 3600 seconds in 1 second increments, is set to any figure other than zero, the **P** push-button becomes an alarm accept button. After an alarm has occurred, operating the **P** button will cause the alarm output to revert to the non-alarm condition for the programmed alarm silence time. If the alarm condition still exists at the end of the silence time, the alarm output will be reactivated. During the silence time the indicator alarm annunciator will flash until the silence time expires or the alarm is cleared.

If the 'FLSH' function, which flashes the indicator display when an alarm occurs has been enabled, it will only function when the alarm output is activated, not during the silence time. See section 9.3.11

To adjust the alarm silence time select 'SiL' from the alarm configuration menu and press **P** which will reveal the existing silence time. The flashing digit of the silence time can be adjusted using the **▲** and **▼** push-buttons, and the **P** button to move control to the other digits. When the required silence time has been entered press **E** to return to the alarm menu.

9.3.11 Flash display when alarm occurs 'FLSH'

In addition to the two alarm annunciators on the top left hand corner of the indicator display which show the status of both alarms, this function provides an even more conspicuous indication that an alarm condition has occurred.

When enabled, the function alternates the indicator display between the numerical value and the alarm reference, 'ALr1' or 'ALr2', when the alarm output is activated. If both alarm outputs are activated, the alarm references are displayed in sequence.

To enable or disable the function select 'FLSH' from the alarm menu and press **P** which will reveal the current setting 'on' or 'off'. The function can be changed by pressing the **▲** or **▼** button followed by the **E** button to return to the alarm menu.

9.3.12 Access setpoint in display mode: ACSP

This function enables a separate menu providing access to the alarm setpoints from the display mode by simultaneously operating the **P** and **▲** push-buttons. An operator can therefore adjust the alarm setpoints without having access to the indicator configuration menu. Protection against accidental adjustment of the setpoints when the

indicator is in the display mode is provided by a separate security code.

This direct setpoint access menu is enabled and the separate security code entered from the 'ACSP' function in the alarm configuration menu as shown in Fig 12. To change the menu parameters select 'ACSP' from the configuration menu and press **P** which will display the enable prompt 'EnbL'. Press **P** again to reveal if the direct access menu is 'on' or 'off'. The **▲** or **▼** button will toggle the display between the two conditions.

If 'off' is selected, the operator will not have access to the setpoints from the display mode. Return to the 'ACSP' prompt in the main menu by pressing **E** twice.

If 'on' is selected, the operator will have direct access to the alarm setpoints from the display mode via a separate optional security code. To define this four digit security code press **P** to return to the 'EnbL' prompt followed by the **▲** or **▼** button to select the access code prompt 'ACCd'. Pressing **P** will reveal the current security code. Each digit of the code may be changed by operating the **▲** and **▼** push-buttons, and the **P** button to move control to the next digit. When the required code has been entered, press **E** twice to return to the 'ACSP' prompt in the configuration menu.

Default code 0000 will disable the security code allowing direct access to the setpoints in the display mode by pressing the **P** and **▲** buttons simultaneously. Unless otherwise requested new instruments with alarms are supplied with this function disabled and the security code set to 0000.

9.3.13 Adjusting alarm setpoints from the display mode

Access to the alarm setpoints from the indicator display mode is obtained by operating the **P** and **▲** push-buttons simultaneously as shown in Fig 14. If the setpoints are not protected by a security code the alarm setpoint prompt 'SP1' will be displayed. If the setpoints are protected by a security code, 'Code' will be displayed first. Pressing **P** again will enable the alarm security code to be entered digit by digit using the **▲** and **▼** buttons to change the flashing digit, and the **P** push-button to move control to the next digit. If the correct code is entered pressing **E** will cause alarm setpoint prompt 'SP1' to be displayed. Pressing the **▲** or **▼** button will toggle the display between the two alarm setpoint prompts 'SP1' and 'SP2'.

If an incorrect security code is entered, or a button is not pressed within twenty seconds, the indicator will automatically return to the display mode.

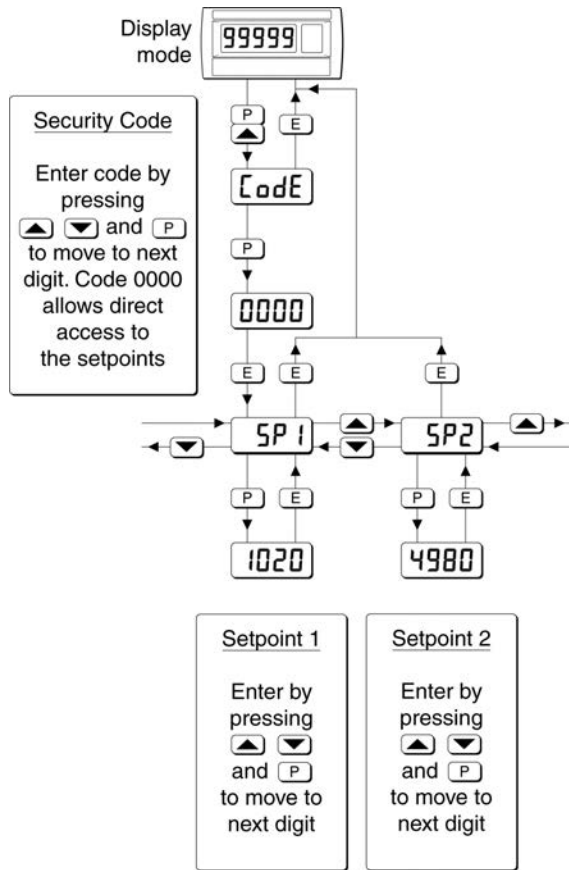

Fig 14 Setpoint adjustment from the display mode

To adjust an alarm setpoint select 'SP1' or 'SP2' and press **P** which will reveal the current setting. Each digit of the setpoint may be adjusted using the **▲** and **▼** push-buttons, and the **P** button to move control to the next digit. When the required setpoint has been entered, pressing **E** will return the display to the 'SP1' or 'SP2' prompt from which the other setpoint may be selected, or the indicator may be returned to the display mode by pressing **E** again.

Note: With the indicator in the display mode, direct access to the alarm setpoints is only available when the ACSP menu is enabled - see section 9.3.12

9.3.14 Displaying setpoints on bargraph

One of the selectable bargraph formats 'AlrSP' allows a low or a high setpoint plus the displayed value to be represented, or a low and a high setpoint plus the displayed value to be represented by the bargraph as shown in Fig 15.

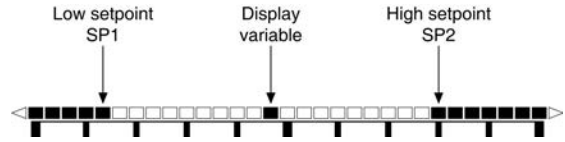

Fig 15 Displayed value and setpoints on bargraph

The bargraph area below the low alarm setpoint and the area above the high alarm setpoint are activated. The displayed variable is represented by an activated bar which moves between these low and high alarm setpoints.

When the activated bar representing the displayed variable is adjacent to the area representing the low or high alarm setpoints, the bar flashes. When a displayed variable equals the low or high alarm the complete bargraph representing the activated alarm flashes irrespective of whether the alarm output has been delayed or cleared.

For this function to operate SP1 must be conditioned as a low alarm and SP2 as a high alarm; SP1 must always be less than SP2. Incorrect configuration is shown by a flashing bargraph scale with no activated bars.

9.4 Display backlight

The BA307E, BA327E, BA308E and BA328E loop powered indicators can be supplied with a factory fitted backlight that may be loop or separately powered.

When loop powered the backlight produces green background illumination enabling the display to be read at night or in poor lighting conditions. No additional power supply, intrinsic safety interface or field wiring are required, but the indicator voltage drop is increased. When separately powered the backlight is brighter, but an additional intrinsic safety interface and field wiring are required.

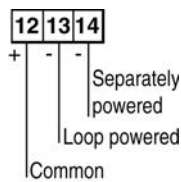

Fig 16 Terminals for optional backlight

9.4.1 Loop powering the backlight

The backlight is loop powered by connecting it in series with the indicator 4/20mA input as shown in Fig 17, which increases the maximum indicator voltage drop from 1.2 to 5V.

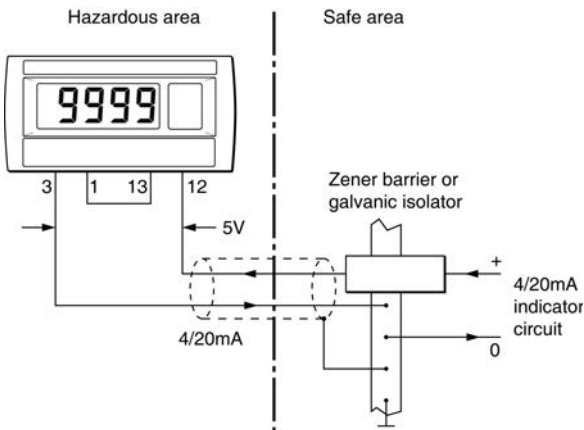

Fig 17 Loop powered backlight

The input intrinsic safety parameters of the combined indicator and backlight are the same as for the indicator alone. The EC-Type Examination Certificate states that for intrinsic safety considerations, under fault conditions the output voltage, current and power of the combined indicator and backlight terminals 1 & 13 will not exceed those specified by clause 5.7 of EN 60079-11 for *simple apparatus*, which simplifies system design and documentation.

Providing the increased voltage drop can be tolerated, the intrinsic safety and system design described in sections 3 and 4 of this manual remain valid with the loop powered backlight.

9.4.2 Separately powering the backlight

The optional backlight may also be powered from a separate safe area power supply via an intrinsically safe interface as shown in Fig 18.

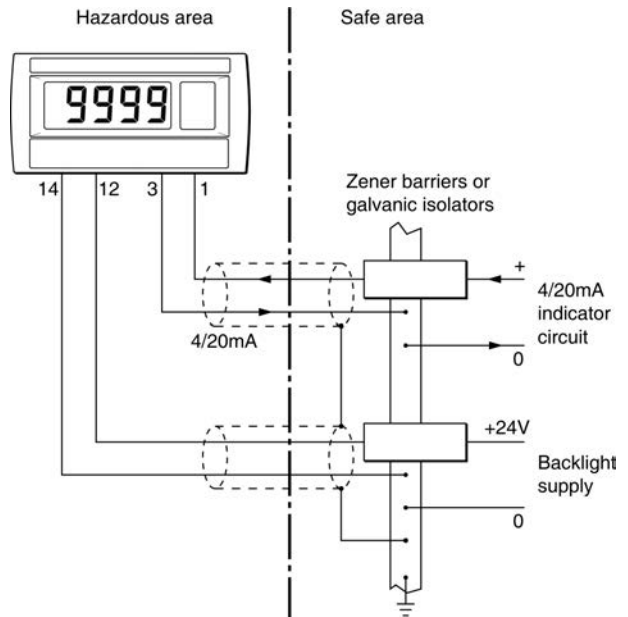

Fig 18 Separately powered backlight

When separately powered the backlight draws a constant current when supply is equal to or greater than the minimum specified voltage. Below this supply voltage the backlight continues to function but with reduced brilliance.

	Current	Minimum voltage
BA307E & BA327E	22.5mA	9.0V
BA308E & BA328E	34.7mA	11.0V

Any certified Zener barrier or galvanic isolator may be used, providing the output parameters do not exceed:

$$\begin{aligned}
 U_o &= 30V \text{ dc} \\
 I_o &= 200mA \\
 P_o &= 0.84W
 \end{aligned}$$

The internal capacitance C_i between terminals 12 & 14 should be subtracted from C_o of the intrinsically safe interface powering the backlight to determine the maximum permissible cable capacitance.

$$\begin{aligned}
 C_i &= 13nF \\
 L_i &= 8\mu H \text{ (Effectively 0)}
 \end{aligned}$$

Two separately powered BA307E or BA327E indicator backlights may be connected in parallel to a single channel 28V, 93mA Zener barrier or galvanic isolator with no noticeable reduction in brilliance on a 24V dc supply.

Appendix 1 Dust certification

A1.0 ATEX dust certification

In addition to ATEX certification permitting installation in explosive gas atmospheres which is described in the main section of this instruction manual, all BA307E, BA327E, BA308E and BA328E indicators have ATEX certification permitting installation in combustible dust atmospheres.

This appendix describes ATEX installations in explosive dust atmospheres conforming with EN 60079-14 Electrical installations design, selection and erection. When designing systems for installation outside the UK the local Code of Practice should be consulted.

The indicator's dust input and output safety parameters are identical to gas parameters, so all the electrical circuits shown in the main section of this manual may also be used for dust applications.

A1.1 Zones, and Maximum Surface Temperature

The BA307E, BA327E, BA308E and the BA328E have been ATEX certified as Group II, Category 1D Ex ia IIIC T80°C Da IP20 apparatus, Ta -40 to 70°C.

When connected to a suitable system the indicators may be installed in:

- Zone 20 explosive atmosphere in the form of a cloud of combustible dust in air is continuously present, or for long periods or frequently.
- Zone 21 explosive atmosphere in the form of a cloud of combustible dust in air is likely to occur occasionally in normal operation.
- Zone 22 explosive atmosphere in the form of a cloud of combustible dust in air is not likely to occur in normal operation, but if it does occur, will only persist for a short period.

Be used with dust in subdivisions:

- IIIA combustible flyings
- IIIB non-conductive dust
- IIIC conductive dust
(For use with IIIC conductive dusts special conditions for safe use apply – see section A1.4)

Having a Minimum Ignition Temperature of:

Dust cloud	120°C
Dust layer on indicator up to 5mm thick	155°C
Dust layer on indicator over 5mm thick.	Refer to EN 60079-14

At an ambient temperature between -40 and +70°C

A1.3 Maintenance

ENSURE PLANT SAFETY BEFORE STARTING MAINTENANCE

Live maintenance is permitted on intrinsically safe equipment installed in a hazardous area, but only certified test equipment should be used.

All models have IP66 front of panel protection and a gasket is provided to seal the joint between the instrument and the mounting panel thus preventing dust ingress from the outside of the mounting panel. The rear of the instruments is not sealed, but ATEX dust certification is dependent on the internal conformal coating of the instrument, so dust ingress is acceptable except for use in IIIC conductive dusts – see A1.4. However, it is good practice to minimise the amount of dust accumulating on the rear of the instrument.

A1.4 Special conditions for use in IIIC dusts

The ATEX certificate has an 'X' suffix indicating that special conditions apply for safe use. In addition to the electrostatic special conditions specified in section 3.3 for installations in IIIC dust atmospheres, the certificate states:

'For use in Group IIIC conductive gas atmospheres, the indicator shall be mounted such that the instrument terminals have at least IP6X protection.'

To prevent the indicator terminals becoming contaminated by conductive dust the indicator must be installed in a panel, cubicle or enclosure providing a minimum of IP6X protection.

The gasket supplied to seal the joint between the indicator and the mounting panel should be used. BA308E and BA328E indicators should be secured with four panel mounting clamps.

Note: These additional special installation conditions only apply for indicators exposed to IIIC conductive dust atmospheres.

Appendix 2 IECEX certification

A2.0 The IECEX Certification Scheme

IECEX is a global certification scheme for explosion protected products which aims to harmonise international certification standards. For additional information about the IECEX certification scheme and to view the BEKA associate certificates, please visit www.iecex.com

A2.1 IECEX Certificate of Conformity

The BA307E, BA327E, BA308E and the BA328E loop powered indicators and the optional accessories have been issued with an IECEX Certificate of Conformity number IECEX ITS 11.0015X which specifies the following certification codes:

Ex ia IIC T5 Ga
Ex ia IIIC T80°C Da
Ta = -40°C to 70°C

The specified gas and dust intrinsic safety parameters are identical to the ATEX safety parameters described in this manual.

The IECEX certificate may be downloaded from www.beka.co.uk, www.iecex.com or requested from the BEKA sales office.

A2.2 Installation

The IECEX and ATEX certificates specify identical safety parameters and installation requirements for both approvals as defined by IEC / EN 60079-14. The ATEX gas and dust installation requirements specified in section 5 and Appendix 1 of this manual may therefore be used for IECEX installations, but the local code of practice should also be consulted.

A2.3 Special conditions for safe use

The IECEX certificate has an 'X' suffix indicating that special conditions apply for safe use.

WARNING

To avoid an electrostatic charge being generated instrument enclosure should only be cleaned with a damp cloth.

A2.4 Special conditions for use in IIIC dusts

The IECEX certificate has an 'X' suffix indicating that special conditions apply for safe use. In addition to the electrostatic special conditions specified in section A2.3 for installations in IIIC dust atmospheres, the certificate states:

'For use in Group IIIC conductive gas atmospheres, the indicator shall be mounted such that the instrument terminals have at least IP6X protection.'

To prevent the indicator terminals becoming contaminated by conductive dust the indicator must be installed in a panel, cubicle or enclosure providing a minimum of IP6X protection.

The gasket supplied to seal the joint between the indicator and the mounting panel should be used. BA308E and BA328E indicators should be secured with four panel mounting clamps.

Note: These additional special installation conditions only apply for indicators exposed to IIIC conductive dust atmospheres.

Appendix 3

**FM Approval for use in the USA and
cFM Approval for use in Canada**

A3.0 Factory Mutual Approval

For installations in the USA and Canada, all models have FM and cFM intrinsic safety and nonincendive approval, project identifications 3041487 and 3041487C. Copies of the Certificates of Compliance are available from the BEKA associates sales office and www.beka.co.uk

A3.1 Intrinsic safety approval

The indicators are approved to FM Class 3610 intrinsic safety standard for use in Division 1 and 2 hazardous (classified) locations. Installations must comply with BEKA associates Control Drawing CI300-72, which is attached to this appendix, ANSI/ISA RP12.06.01 'Installation of Intrinsically Safe Systems for Hazardous (Classified) Locations' and with the National Electrical Code ANSI/NFPA70. Installations in Canada must comply with the Canadian Electrical Code C22.2

The front of all the models have IP66 (Type 4X) protection. To obtain an IP66 seal between the indicator and the panel in which it is mounted, the installation must comply with note 11 of Control Drawing CI300-72.

All the models have a T5 rating at ambient temperatures up to +70°C and may be used with the following gases:

Intrinsic Safety	
Division 1 or 2	
Class I	Group A & B Group C Group D
Zone 0, 1 or 2	
Class 1	Group IIC Group IIB Group IIA

The FM and cFM entity parameters are similar to the ATEX and IECEx parameters and the systems shown in section 4 of this manual may therefore also be used for FM and cFM installations.

A3.2 Nonincendive approval



All the models are FM Class 3611 nonincendive approved allowing installation in Division 2 hazardous (classified) locations without the need for Zener barriers or galvanic isolators. US installations must comply with the BEKA associates Control Drawing CI300-73, which is attached to this appendix, and with the National Electrical Code ANSI/NFPA70.



Canadian nonincendive installations must comply with the Canadian Electrical Code C22.2 and with BEKA associates Control Drawing CI300-73, which is attached to this appendix.



The front of all the models have IP66 (Type 4X) protection. To obtain an IP66 seal between the indicator and the panel in which it is mounted, the installation must comply with note 6 of Control Drawing CI300-73.

All the models have a T5 rating at ambient temperatures up to +70°C and may be used with the following gases:

Nonincendive	
Division 2	
Class I	Group A & B Group C Group D
Class II	Groups E, F & G
Class III	
Zone 2	
Class I	Group IIC Group IIB Group IIA

Iss.		Date		Modification		Ckd.		Appd.																
1		13.10 2010		New drawing																				
2		27.06 2012		ATEX parameters added. No change to this sheet																				
 BEKA associates Hitchin England company confidential, copyright reserved.																								
Iss.		Date		Modification		Ckd.		Appd.																
3		12.12 2014		BA307E-SS & BA327E-SS ADDED																				
<p>Notes</p> <ol style="list-style-type: none"> The associated protective barriers and galvanic isolators shall be FM approved and the manufacturers instructions shall be followed when installing this equipment. For installations in Canada the associated protective barriers and galvanic isolators shall be cFM or CSA approved and the manufacturers installation drawings shall be followed when installing this equipment. The unclassified location equipment shall not use or generate more than 250V rms or 250V dc. Installations shall be in accordance with ANSI/ISA RP 12.06.01 'Installation of Intrinsically Safe Systems for Hazardous (Classified) Locations' and the National Electrical Code ANSI/NFPA 70. Installations in Canada shall be in accordance with the Canadian Electrical Code C22.2. One single channel or one two channel associated protective barrier or galvanic isolator with entity parameters complying with the following requirements: <table border="0" style="width: 100%; margin-top: 10px;"> <tr> <td style="width: 15%;">U_o</td> <td style="width: 35%;">equal or less than</td> <td style="width: 50%;">The lowest U_i of the FM, cFM or CSA approved apparatus installed in the loop.</td> </tr> <tr> <td>I_o</td> <td>equal or less than</td> <td>The lowest I_i of the FM, cFM or CSA approved apparatus installed in the loop.</td> </tr> <tr> <td>P_o</td> <td>equal or less than</td> <td>The lowest P_i of the FM, cFM or CSA approved apparatus installed in the loop.</td> </tr> <tr> <td>L_o</td> <td>equal or greater than</td> <td>The sum of the cable inductances and the internal inductances L_i of each FM, cFM or CSA approved apparatus in the loop.</td> </tr> <tr> <td>C_o</td> <td>equal or greater than</td> <td>The sum of the cable capacitance and the internal capacitance C_i of each FM, cFM or CSA approved apparatus in the loop.</td> </tr> </table> 										U_o	equal or less than	The lowest U_i of the FM, cFM or CSA approved apparatus installed in the loop.	I_o	equal or less than	The lowest I_i of the FM, cFM or CSA approved apparatus installed in the loop.	P_o	equal or less than	The lowest P_i of the FM, cFM or CSA approved apparatus installed in the loop.	L_o	equal or greater than	The sum of the cable inductances and the internal inductances L_i of each FM, cFM or CSA approved apparatus in the loop.	C_o	equal or greater than	The sum of the cable capacitance and the internal capacitance C_i of each FM, cFM or CSA approved apparatus in the loop.
U_o	equal or less than	The lowest U_i of the FM, cFM or CSA approved apparatus installed in the loop.																						
I_o	equal or less than	The lowest I_i of the FM, cFM or CSA approved apparatus installed in the loop.																						
P_o	equal or less than	The lowest P_i of the FM, cFM or CSA approved apparatus installed in the loop.																						
L_o	equal or greater than	The sum of the cable inductances and the internal inductances L_i of each FM, cFM or CSA approved apparatus in the loop.																						
C_o	equal or greater than	The sum of the cable capacitance and the internal capacitance C_i of each FM, cFM or CSA approved apparatus in the loop.																						
Date		13.10 2010		Title		Drawn		Checked																
1		27.06 2012		FM & cFM Intrinsically Safe Control Drawing for BA304E, BA307E, BA307E-SS & 308E 4 DIGIT INDICATORS BA324E, 327E, BA327E-SS & BA328E 5 DIGIT INDICATORS BA354E & BA358E RATE TOTALISERS		RC		 Scale -																
2						Drawing No.		Sheet 3																
								CI300-72																

Iss.	1	Date	13.10 2010	Modification		Ckd.		Appd.	
Iss.	2	Date	27.06 2012	Modification	ATEX parameters added. Note 13 Note 11 should>shall 4 places	Ckd.		Appd.	
Iss.	3	Date	12.12 2014	Modification	BA307E-SS & BA327E-SS ADDED	Ckd.		Appd.	
									
<p>8. In addition to the supplied bonding plate, when 2 or 3 metallic glands or conduit hubs are fitted to a BA304E or BA324E Indicator or to a BA354E Rate Totaliser, all metallic glands or conduit hubs must be connected together and grounded.</p> <p>9. CAUTION The BA304E, BA307E, BA308E, BA324E, BA327E and the BA328E Indicators and the BA354E and the BA358C Rate Totaliser enclosures are manufactured from conducting plastic per Article 250 of the National Electrical Code.</p> <p>10. The BA304E, BA307E, BA308E, BA324E, BA327E and the BA328E Indicators and the BA354E and the BA358C Rate Totaliser shall be mounted where they are shielded from direct sunlight.</p> <p>11. When mounting the BA307E, BA308E, BA327E and the BA328E panel mounting Indicators and the BA358C panel mounting Rate Totaliser in an enclosure to maintain Type 4 front panel rating:</p> <p>Minimum panel thickness should be:</p> <p style="margin-left: 40px;">2mm (0.08inches) Steel 3mm (0.12inches) Aluminium</p> <p>Outside panel finish should be smooth, free from particles, inclusions, runs or build-ups around cut-out.</p> <p>Panel cut-out for BA307E and BA327E shall be:</p> <p style="margin-left: 40px;">90.0 x 43.5mm -0.0 +0.5mm (3.54 x 1.71 inches -0.00 +0.02)</p> <p>Two panel mounting clips are required and each shall be tightened to between:</p> <p style="margin-left: 40px;">20 & 22cNm (1.77 to 1.95inLb)</p> <p>Panel cut-out for BA308E, BA328E & BA358E shall be:</p> <p style="margin-left: 40px;">66.2 x 136.0mm-0.0 +0.5mm (2.60 x 5.35 inches -0.00 +0.02)</p> <p>Four panel mounting clips are required and each shall be tightened to between:</p> <p style="margin-left: 40px;">20 & 22cNm (1.77 to 1.95inLb)</p> <p>12. BA304E, BA307E, BA307E-SS, BA308E, BA324E, BA327E, BA327E-SS & BA328E loop powered Indicators and BA354E & BA358E loop powered Rate Totalisers.</p>									
Title FM & cFM Intrinsically Safe Control Drawing for BA304E, BA307E, BA307E-SS & 308E 4 DIGIT INDICATORS BA324E, 327E, BA327E-SS & BA328E 5 DIGIT INDICATORS BA354E & BA358E RATE TOTALISERS				Drawn RC	Checked 	Scale -			
				Drawing No. Sheet 5	CI300-72				

Iss.	Date	Modification	Ckd.	Appd.		Iss.	Date	Modification	Ckd.	Appd.	<p>13. Safety parameters</p> <p>4/20mA input terminals 1, 2, 3 & 4</p> <p>Ui = 30V li = 200mA Pi = 0.84W Uo = 1.1V Io = 3mA Po = 4.5mW</p> <p>Ci = 13nF Li = 0.01mH</p> <p>Separately powered backlight terminals 12 & 14.</p> <p>Ui = 30V li = 200mA Pi = 0.84W</p> <p>Ci = 13nF Li = 0.01mH</p> <p>Reset terminals RS1 & RS2 BA354E & BA358E rate totaliser only.</p> <p>Ui = 30V li = 200mA Pi = 0.84W Uo = 6V Io = 2.5mA Po = 3.8mW</p> <p>Ci = 13nF Li = 0.01mH Co = 53nF Lo = 0.79mH</p> <p>14. When mounting a BA307E-SS or BA327E-SS panel mounting indicator in an AEx e, AEx n, AEx p or AEx t certified enclosure, or an enclosure to maintain IP66 front panel rating, the panel cut-out shall be:</p> <p>92.0 +0.8/-0.0 x 45.0 +0.6/-0.0 mm (3.62 +0.03/-0.0 x 1.77 +0.02/-0.0 inches)</p> <p>4 panel mounting clamps are required and each shall be tightened to a minimum of 22cNm (1.95 inLB)</p> <p>When correctly installed the BA307E-SS and BA327E-SS will not invalidate the certification of an AEx e, AEx n, AEx p or AEx t panel enclosure.</p>	
												3
1	13.10 2010					1	27.06 2012	ATEX parameters added.			<p>Title FM & cFM Intrinsically Safe Control Drawing for BA304E, BA307E, BA307E-SS & 308E 4 DIGIT INDICATORS BA324E, 327E, BA327E-SS & BA328E 5 DIGIT INDICATORS BA354E & BA358E RATE TOTALISERS</p>	<p>Drawn RC</p> <p>Checked </p> <p>Scale -</p>
2											<p>Drawing No. CI300-72</p> <p>Sheet 6</p>	

Appd.		Ckd.		Modification		Date		Iss.	
				Class II & III added to BA307E BA327E, BA308E, BA328E & BA358E BA307E-SS and BA327E-SS ADDED		03.10 2012		3	
						12.12 2014		4	
				New drawing		11.04 2012		ATEX parameters added. See sheet 5	
				Title		Drawn		Checked	
				FM & cFM Nonincendive Control Drawing for BA304E, BA307E, BA307E-SS & 308E 4 DIGIT INDICATORS BA324E, 327E, BA327E-SS & BA328E 5 DIGIT INDICATORS BA354E & BA358E RATE TOTALISERS		RC			
				Scale		Sheet 1 of 5		CI300-73	

HAZARDOUS LOCATION	See note 3	NON-HAZARDOUS LOCATION
Locations BA304E, BA324E and BA354E Class I, Division 2, Groups A, B, C & D Class II, Division 2, Groups E, F & G Class III or Class I, Zone 2, Groups IIC		See note 1
BA307E, BA327E, BA308E, BA328E and BA358E Class I, Division 2, Groups A, B, C & D Class II, Division 2, Groups E, F & G Class III or Class I, Zone 2, Groups IIC		
BA307E-SS and BA327E-SS Class I, Division 2, Groups A, B, C & D or Class I, Zone 2, Groups IIC		

Reset	RS1	7	See note 7
Optional Alarm	8	9	See note 3
Optional Alarm	10	11	See note 3
Optional separately powered Backlight	12	14	See note 3
See notes 11 & 12	1	2	See note 3
	3	4	

Reset	RS1	7	See note 7
Optional Alarm	8	9	See note 3
Optional Alarm	10	11	See note 3
Optional separately powered Backlight	12	14	See note 3
See notes 11 & 12	1	2	See note 3
	3	4	

Hazardous Location Equipment See note 4	See note 2
--	------------

<p>BEKA associates Hitchin England company confidential, copyright reserved.</p>		<p>Iss. 3</p>	<p>Date 03.10 2012</p>	<p>Modification No change to this sheet. See sheets 1 and 2.</p>	<p>Ckd.</p>	<p>Appd.</p>	
<p>Iss. 4</p>		<p>Date 12.12 2014</p>	<p>Modification BA307E-SS and BA327E-SS ADDED</p>	<p>6. When mounting the BA307E, BA308E, BA327E and the BA328E panel mounting Indicators and the BA358C panel mounting Rate Totaliser in an enclosure to maintain Type 4 front panel rating:</p> <p>Minimum panel thickness should be 2mm (0.08inches) Steel 3mm (0.12inches) Aluminium</p> <p>Outside panel finish should be smooth, free from particles, inclusions, runs or build-ups around cut-out.</p> <p>Panel cut-out for BA307E and BA327E should be: 90.0 x 43.5mm -0.0 +0.5mm (3.54 x 1.71 inches -0.00 +0.02)</p> <p>Two panel mounting clips are required and each should be tightened to between: 20 & 22cNm (1.77 to 1.95inLb)</p> <p>Panel cut-out for BA308E, BA328E & BA358E should be: 66.2 x 136.0mm-0.0 +0.5mm (2.60 x 5.35 inches -0.00 +0.02)</p> <p>Four panel mounting clips are required and each should be tightened to between: 20 & 22cNm (1.77 to 1.95inLb)</p> <p>7. Reset terminals RS1 and RS2 are only fitted to BA354E and BA358E Rate Totalisers. They may be connected to Associated Nonincendive Field Wiring Apparatus, Nonincendive Field Wiring Apparatus or simple apparatus such as a single pole switch.</p> <p>8. In addition to the supplied bonding plate, when 2 or 3 metallic glands or conduit hubs are fitted to a BA304E or BA324E Indicator or to a BA354E Rate Totaliser, all metallic glands or conduit hubs must be connected together and grounded.</p> <p>9. CAUTION The BA304E, BA307E, BA308E, BA324E, BA327E and the BA328E Indicators and the BA354E and the BA358C Rate Totaliser enclosures are manufactured from conducting plastic per Article 250 of the National Electrical Code.</p> <p>10. The BA304E, BA307E, BA308E, BA324E, BA327E and the BA328E Indicators and the BA354E and the BA358C Rate Totaliser shall be mounted where they are shielded from direct sunlight.</p>			
<p>Iss. 1</p>	<p>Date 15.10 2010</p>	<p>Modification New drawing</p>	<p>Ckd.</p>	<p>Appd.</p>	<p>Title FM & cFM Nonincendive Control Drawing for BA304E, BA307E, BA307E-SS & 308E 4 DIGIT INDICATORS BA324E, 327E, BA327E-SS & BA328E 5 DIGIT INDICATORS BA354E & BA358E RATE TOTALISERS</p>		
<p>Iss. 2</p>	<p>Date 11.04 2012</p>	<p>Modification ATEX parameters added. See sheet 5</p>	<p>Ckd.</p>	<p>Appd.</p>	<p>Drawn RC</p>	<p>Checked </p>	<p>Scale -</p>
					<p>Drawing No. CI300-73</p>	<p>Sheet 4</p>	

<p style="text-align: center;">BEKA associates England Hitchin company confidential, copyright reserved.</p>	Iss.	3	Date	03.10 2012	Modification	No change to this sheet. See sheets 1 and 2.	Ckd.		Appd.	
	Iss.	4	Date	12.12 2014	Modification	BA307E-SS and BA327E-SS ADDED	Ckd.		Appd.	
	<p>11. Safety parameters</p> <p>4/20mA input terminals 1, 2, 3 & 4</p> <p style="margin-left: 40px;"> $U_i = 30V$ $I_i = 200mA$ $P_i = 0.84W$ $U_o = 1.1V$ $I_o = 3mA$ $P_o = 4.5mW$ </p> <p style="margin-left: 40px;"> $C_i = 13nF$ $L_i = 0.01mH$ </p> <p>4/20mA input terminals 1, 2, 3, 4, 12 & 13 & loop powered backlight.</p> <p style="margin-left: 40px;"> $U_i = 30V$ $I_i = 200mA$ $P_i = 0.84W$ $U_o = 1.1V$ $I_o = 3mA$ $P_o = 4.5mW$ </p> <p style="margin-left: 40px;"> $C_i = 13nF$ $L_i = 0.01mH$ </p> <p>Separately powered backlight terminals 12 & 14.</p> <p style="margin-left: 40px;"> $U_i = 30V$ $I_i = 200mA$ $P_i = 0.84W$ </p> <p style="margin-left: 40px;"> $C_i = 13nF$ $L_i = 0.01mH$ </p> <p>Alarm terminals 8, 9, 10 and 11</p> <p style="margin-left: 40px;"> $U_i = 30V$ $I_i = 200mA$ $P_i = 0.84W$ $U_o = 1.47V$ $I_o = 1.0\mu A$ $P_o = 2.2\mu W$ </p> <p style="margin-left: 40px;"> $C_i = 24nF$ $L_i = 0.01mH$ </p> <p>Reset terminals RS1 & RS2 BA354E & BA358E rate totaliser only.</p> <p style="margin-left: 40px;"> $U_i = 30V$ $I_i = 200mA$ $P_i = 0.84W$ $U_o = 6V$ $I_o = 2.5mA$ $P_o = 3.8mW$ </p> <p style="margin-left: 40px;"> $C_i = 13nF$ $L_i = 0.01mH$ $C_o = 53nF$ $L_o = 0.79mH$ </p>									
	<p>12. BA304E, BA307E, BA307E-SS, BA308E, BA324E, BA327E, BA327E-SS & BA328E loop powered Indicators and BA354E & BA358E loop powered Rate Totalisers.</p> <p>13. When mounting a BA307E-SS or BA327E-SS panel mounting indicator in an enclosure to maintain IP66 front panel rating, the panel cut-out shall be:</p> <p style="margin-left: 40px;">92.0 +0.8/-0.0 x 45.0 +0.6/-0.0 mm (3.62 +0.03/-0.0 x 1.77 +0.02/-0.0 inches)</p> <p style="margin-left: 40px;">4 panel mounting clamps are required and each shall be tightened to a minimum of 22cNm (1.95 inLB)</p>									
Iss.	1	Date	15.10 2010	Modification	New drawing	<p>Title FM & cFM Nonincendive Control Drawing for BA304E, BA307E, BA307E-SS & 308E 4 DIGIT INDICATORS BA324E, 327E, BA327E-SS & BA328E 5 DIGIT INDICATORS BA354E & BA358E RATE TOTALISERS</p>				
		Date	11.04 2012	Modification	ATEX parameters added.	<p>Drawn RC</p>		<p>Checked </p>	<p>Scale -</p>	
						<p>Drawing No. CI300-73</p>				
						<p>Sheet 5</p>				



SCATTERGOOD & JOHNSON LTD

ELECTRICAL ENGINEERING & FLUID CONTROL DISTRIBUTORS

Est.1899

At Scattergood & Johnson Ltd, we pride ourselves on being a technical distributor to specialist industries.

Working with a range of quality product suppliers across a number of specialist markets, we are not your average 'box shifter' - we are your technical and supply chain partner.

We fully support every product we sell - for free! Our internal team and external sales engineers can answer any product or application question, no matter the complexity.

Backing up this technical ability is a range of 50,000+ products available from stock for nationwide next day delivery (same day if required!), or you can collect what you need from any of our trade counters around the UK.

Select your specialist interest below to learn more about how we can help.

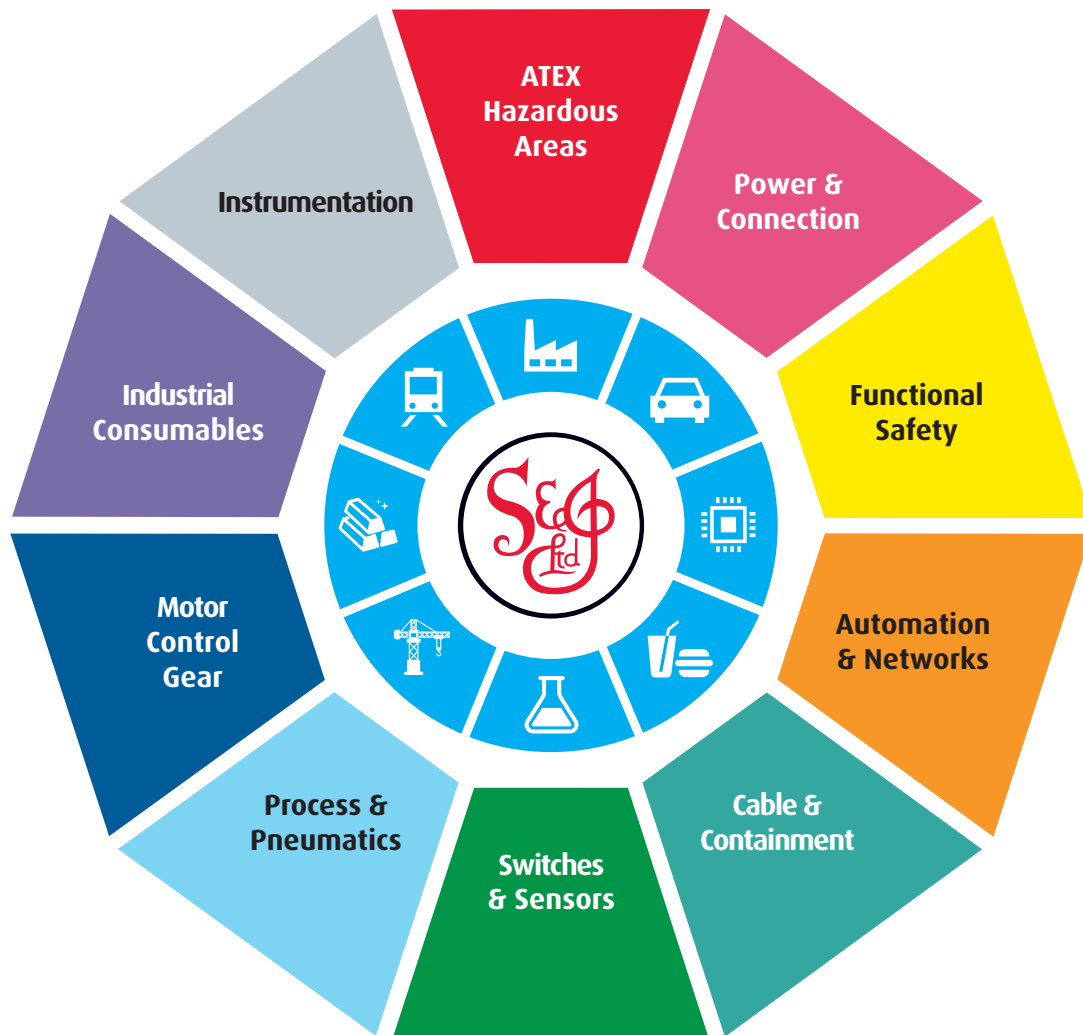

Online, In Branch and On the Road - Scattergood & Johnson Ltd, there when you need us.

www.scatts.co.uk