

# MINI SPOOL VALVES

air operated

ØM5 - G 1/8 - G 1/4 tapped body  
adjustable on joinable subbases

**3/2-5/2-5/3**  
Series  
**519-520-521**

### GENERAL

FLUID : Air or neutral gas, filtered, lubricated or not  
 PORTS : M 5 - G 1/8 - G 1/4  
 ORIFICE Ø : 2,5 - 4 - 6 mm  
 PRESSURE : 0 to 8 bar (1,5 to 8 bar with differential return)  
 PILOT PRESSURE : 1,5 to 8 bar  
 TEMPERATURE : +5 °C, +50 °C  
 FLOW (Qv at 6 bar) : see table below  
 FUNCTIONS : 3/2 - 5/2 - 5/3  
 MOUNTING : individual or on joinable subbases



### CONSTRUCTION

Body in polyamide or light alloy, cover in acetal resin (POM)  
 Internal parts in stainless steel, light alloy and acetal resin (POM)  
 Sealings in nitrile (NBR)

1 = Pressure                      12 = Return  
 2,4 = Outlets                    14 = Pilot  
 3,5 = Exhausts

### SPECIFICATIONS

| Functions  | Symbols | Operators                                      |              | Pipe size | Orifice size (mm) | Flow                 |          | catalogue number |
|------------|---------|--|--------------|-----------|-------------------|----------------------|----------|------------------|
|            |         | Pilot (14)                                     | Return (12)  |           |                   | at 6 bar (l/min) ANR | coef. KV |                  |
| <b>3/2</b> |         | Air  | Differential | G 1/8     | 4                 | 400                  | 5,7      | <b>52000376</b>  |
|            |         | Air  | Spring       | G 1/8     | 4                 | 400                  | 5,7      | <b>52000330</b>  |
| <b>5/2</b> |         | Air  | Differential | M5        | 2,5               | 175                  | 2,5      | <b>51900077</b>  |
|            |         | Air  | Differential | G 1/8     | 4                 | 600                  | 8,5      | <b>52000077</b>  |
|            |         | Air  | Differential | G 1/4     | 6                 | 1050                 | 15       | <b>52100077</b>  |
|            |         | Air  | Air          | M5        | 2,5               | 175                  | 2,5      | <b>51900078</b>  |
| Air        | Air     | G 1/8  | 4            | 600       | 8,5               | <b>52000078</b>      |          |                  |
| Air        | Air     | G 1/4  | 6            | 1050      | 15                | <b>52100078</b>      |          |                  |
| <b>5/3</b> |         | Pressure held<br><b>W 1</b><br>Air operated    |              | G 1/8     | 4                 | 600                  | 8,5      | <b>52000079</b>  |
|            |         | Pressure applied<br><b>W 2</b><br>Air operated |              | G 1/8     | 4                 | 600                  | 8,5      | <b>52000142</b>  |
|            |         | Pressure applied<br><b>W 2</b><br>Air operated |              | G 1/4     | 6                 | 1050                 | 15       | <b>52100142</b>  |
| <b>5/3</b> |         | Pressure release<br><b>W 3</b><br>Air operated |              | G 1/8     | 4                 | 600                  | 8,5      | <b>52000082</b>  |
|            |         | Pressure release<br><b>W 3</b><br>Air operated |              | G 1/4     | 6                 | 1050                 | 15       | <b>52100082</b>  |

### ACCESSORIES

• 520 Series: Flange for ports 2 - 4 with instant fittings for flexible tube, catalogue number **88135532**

**SUBBASES** : Joinable subbases, check the online configurator on: [www.asco.com](http://www.asco.com)

All leaflets are available on: [www.asco.com](http://www.asco.com)

**DIMENSIONS AND WEIGHTS**

**3/2**

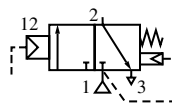
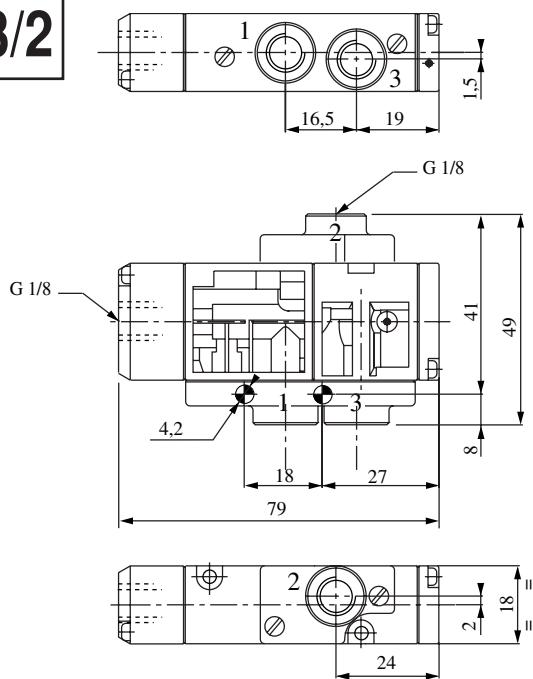

|                |
|----------------|
| <br>520 = 45 g |
|----------------|

**5/2**

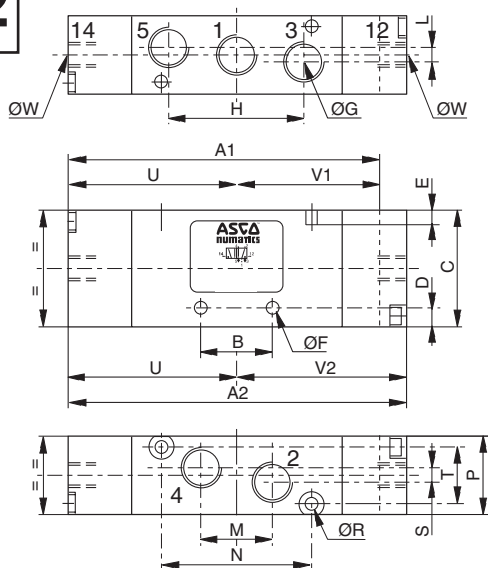

| Series | B   | C  | D  | E   | ØF | ØG  | H    | L    | M | N    | P  | ØR | S   | T | U  | ØW   |      |
|--------|-----|----|----|-----|----|-----|------|------|---|------|----|----|-----|---|----|------|------|
| 5/2    | 519 | 11 | 26 | 4   | 4  | 3,3 | M5   | 21,6 | - | 11   | 19 | 15 | 2,7 | 6 | 11 | 30,5 | M5   |
|        | 520 | 15 | 27 | 6   | 3  | 3,3 | G1/8 | 32,4 | 3 | 16,2 | 35 | 18 | 3,2 | - | 13 | 42,5 | G1/8 |
|        | 521 | 22 | 31 | 6,5 | 4  | 4,3 | G1/4 | 44   | 4 | 22   | 50 | 22 | 4,2 | 4 | 16 | 50   | G1/8 |

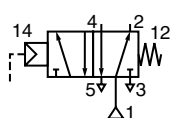

| Series | A1  | V1   |
|--------|-----|------|
| 5/2    | 519 | -    |
|        | 520 | 85,3 |
|        | 521 | -    |

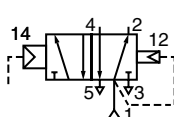

| Series | A1  | V1   |
|--------|-----|------|
| 5/2    | 519 | 55,5 |
|        | 520 | 76   |
|        | 521 | 91,5 |

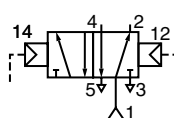

| Series | A2  | V2  |
|--------|-----|-----|
| 5/2    | 519 | 61  |
|        | 520 | 85  |
|        | 521 | 100 |

|   |
|---|
| <br>519   50 g<br>520   65 g<br>521   110 g |
|---|

**5/3**

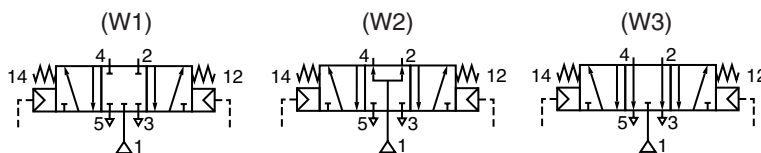
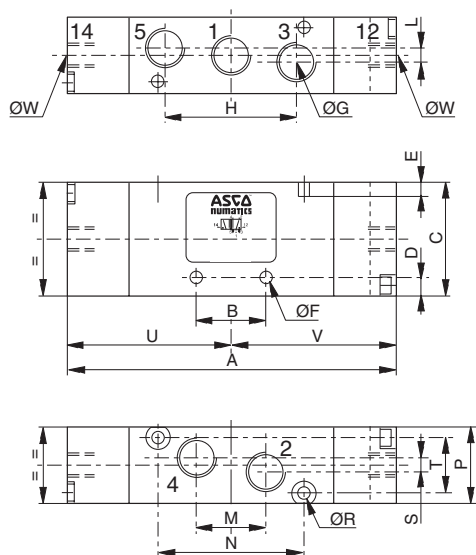

| Series | A   | B   | C  | D  | E   | ØF | ØG  | H    | L    | M | N    | P  | ØR | S   | T | U  | V    | ØW   |      |
|--------|-----|-----|----|----|-----|----|-----|------|------|---|------|----|----|-----|---|----|------|------|------|
| 5/3    | 520 | 94  | 15 | 27 | 6   | 3  | 3,3 | G1/8 | 32,4 | 3 | 16,2 | 35 | 18 | 3,2 | - | 13 | 42,5 | 51,5 | G1/8 |
|        | 521 | 109 | 22 | 31 | 6,5 | 4  | 4,3 | G1/4 | 44   | 4 | 22   | 50 | 22 | 4,2 | 4 | 16 | 50   | 59   | G1/8 |

|                               |
|-------------------------------|
| <br>520 = 75 g<br>521 = 120 g |
|-------------------------------|



# SCATTERGOOD & JOHNSON LTD

ELECTRICAL ENGINEERING & FLUID CONTROL DISTRIBUTORS

Est.1899

At Scattergood & Johnson Ltd, we pride ourselves on being a technical distributor to specialist industries.

Working with a range of quality product suppliers across a number of specialist markets, we are not your average 'box shifter' - we are your technical and supply chain partner.

We fully support every product we sell - for free! Our internal team and external sales engineers can answer any product or application question, no matter the complexity.

Backing up this technical ability is a range of 50,000+ products available from stock for nationwide next day delivery (same day if required!), or you can collect what you need from any of our trade counters around the UK.

Select your specialist interest below to learn more about how we can help.



Online, In Branch and On the Road - Scattergood & Johnson Ltd, there when you need us.

# [www.scatts.co.uk](http://www.scatts.co.uk)