

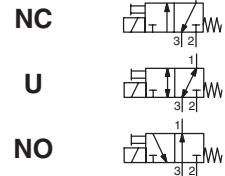

# SOLENOID VALVES

direct operated  
1/8 - 1/4



**3/2**  
Series  
**356**

## FEATURES

- Compact design for the control of single-acting actuators or filling and draining cycles
- Wide range of flow and pressure ratings
- Quick disassembly of core tube for easy maintenance of internal parts
- Standard disc seal made of FPM suitable for a wide range of operating temperatures and compatible with many fluids
- Standard manual operator allows an easy installation
- AC/DC interchangeability of the solenoid without disassembly of the valve
- Compliance with UL and CSA standards (coil 4/6,9 W)
- Compact and low weight valve
- The solenoid valves satisfy all relevant EU directives

## GENERAL

**Differential pressure** See «SPECIFICATIONS» [1 bar =100 kPa]  
**Maximum viscosity** 40 cSt (mm<sup>2</sup>/s)  
**Response time** 5 - 10 ms

fluids (*)	temperature range (TS)	seal materials (*)
air, inert gas, water, oil	-10°C to +100°C	FPM (fluoroelastomer)

## MATERIALS IN CONTACT WITH FLUID

(\*) Ensure that the compatibility of the fluids in contact with the materials is verified

	Brass body	Stainless steel body
<b>Body</b>	Brass	AISI 316
<b>Core tube</b>	Stainless steel	Stainless steel
<b>Core and plugnut</b>	Stainless steel	Stainless steel
<b>Springs</b>	Stainless steel	Stainless steel
<b>Seat</b>	Brass	Stainless steel
<b>Seals</b>	FPM	FPM
<b>Disc</b>	FPM	FPM
<b>Shading coil</b>	Copper	Copper

## ELECTRICAL CHARACTERISTICS

**Coil insulation class** F  
**Connector** Spade plug (cable Ø 6-8 mm or Ø 6-10 mm)  
**Connector specification** DIN 43650, 11 mm, industry standard B (type 01) or ISO 4400 / EN 175301-803, form A (type 02) IEC 335  
**Electrical safety** Moulded IP65 (EN 60529)  
**Electrical enclosure protection** DC (=) : 24V - 48V  
**Standard voltages** AC (~) : 24V - 48V - 115V - 230V / 50 Hz  
 (Other voltages and 60 Hz on request)

prefix option	power ratings				operator ambient temperature range (TS) (C°)	replacement coil		type <sup>(1)</sup>
	inrush ~		holding ~			~	=	
	(VA)	(VA)	(W)	(W)		230 V/50 Hz	24 V DC	
SC	12	6	4	5 / 6,9	-10 to +60	400127-197	400127-142	01
	15	7	5	4 / 5	-10 to +60	400727-117	400727-185	02

<sup>(1)</sup> Refer to the dimensional drawings on the following page.

## SPECIFICATIONS

pipe size	orifice size	flow coefficient Kv				operating pressure differential (bar)				power coil (W)		catalogue number		options	
		2→1		3→1		min.	max. (PS)		~	=	brass	stainless steel	EPDM		
		(m <sup>3</sup> /h)	(l/min)	(m <sup>3</sup> /h)	(l/min)		air, water, oil (*)	=							
G	(mm)	(m <sup>3</sup> /h)	(l/min)	(m <sup>3</sup> /h)	(l/min)		~	=	~	=	~/=	~/=			
<b>NC - Normally closed</b>															
1/8 <sup>(2)</sup>	1,2	0,05	0,8	0,05	0,8	0	15	15	4	6,9	SCG356B001VMS	SCG356B013VMS	E	-	-
	1,6	0,08	1,33	0,05	0,8	0	10	10	4	6,9	SCG356B002VMS	SCG356B014VMS	E	-	-
	2,0	0,1	1,66	0,05	0,8	0	5	5	4	6,9	SCG356B003VMS	SCG356B015VMS	E	-	-
	2,4	0,13	2,1	0,05	0,8	0	4	4	4	6,9	SCG356B004VMS	SCG356B016VMS	E	-	-
1/4 <sup>(2)</sup>	1,6	0,08	1,33	0,05	0,8	0	10	10	5	5	SCG356B466VMS	SCG356B434VMS	-	-	-
	2,4	0,16	2,67	0,05	0,8	0	4	4	5	5	SCG356B470VMS	SCG356B436VMS	-	-	-
<b>U - Universal</b>															
1/8 <sup>(2)</sup>	1,6	0,06	1	0,05	0,8	0	4,5	4,5	4	6,9	SCG356B010VMS	SCG356B022VMS	E	-	-
	2,0	0,08	1,33	0,05	0,8	0	3	3	4	6,9	SCG356B011VMS	SCG356B023VMS	E	-	-
	2,4	0,09	1,5	0,05	0,8	0	2	2	4	6,9	SCG356B012VMS	SCG356B024VMS	E	-	-
<b>NO - Normally open</b>															
1/8 <sup>(2)</sup>	1,6	0,096	1,6	0,05	0,8	0	8,5	8,5	4	6,9	SCG356B006VMS	SCG356B018VMS	E	-	-

<sup>(2)</sup> Pipe size port 3: M5 (Orifice size = 1,2 mm).

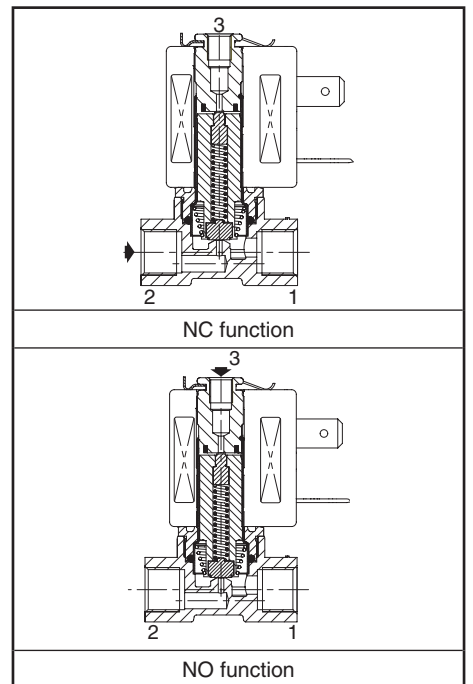

**OPTIONS**

- Valves can also be supplied with EPDM (ethylene-propylene) seals and discs. Use the appropriate optional suffix letter for identification (1/8 version only)
- Explosionproof enclosures for use in zones 1/21-2/22, categories 2-3 to ATEX Directive 2014/34/EU ([www.asco.com](http://www.asco.com))
- Flying leads coil, use prefix L (e.g.: LG356B001VMS) (4 W/6,9 W coil only)
- Oxygen service with seals and disc in FPM, suffix NV, example: SCG356B001NVMS
- Solenoid valves integrated on manifold, orifice sizes 1,2 - 1,6 - 2 - 2,4 mm ([www.asco.com](http://www.asco.com))
- Without manual operator, on request
- Other pipe connections are available on request
- Connector with visual indication and peak voltage suppression or with cable length of 2 m ([www.asco.com](http://www.asco.com))

**INSTALLATION**

- The solenoid valves can be mounted in any position without affecting operation
- Solenoid valves have 2 mounting holes in body
- Pipe connection identifier is G = G (ISO 228/1)
- Installation/maintenance instructions are included with each valve

**ORDERING EXAMPLES:**

SC	G	356	B 001	VMS	230V / 50 Hz
SC	G	356	B 002	EMS	115V / 50 Hz
SC	G	356	B 014	NVMS	24V / DC
SC	G	356	B 001	FWMS	24V / DC
SC	G	356	B 456	VMS	230V / 50 Hz
SC	G	356	B 006	VMS	230V / 50 Hz

prefix: SC  
 pipe thread: G  
 basic number: 356  
 voltage: 230V / 50 Hz  
 suffix: VMS

**DIMENSIONS (mm), WEIGHT (kg)**

**TYPE 01**

Prefix "SC" Solenoid  
Epoxy moulded  
IEC 335 / DIN 43650  
IP65

NC/NO/U (1/8): All 1/8 catalogue numbers

**TYPE 02**

Prefix "SC" Solenoid  
Epoxy moulded  
IEC 335 / ISO 4400  
IP65

NC (1/4): SCG356B434VMS/436VMS/466VMS/470VMS/471V/472V

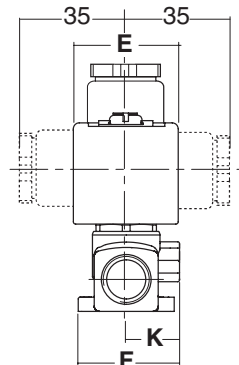
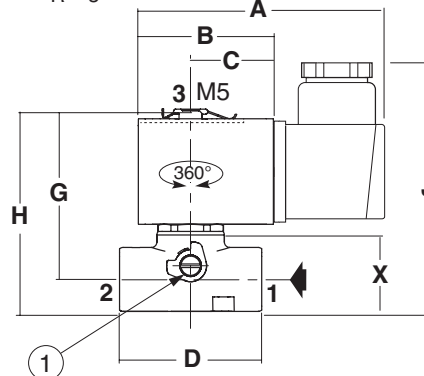
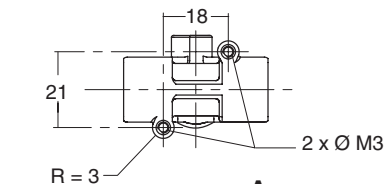
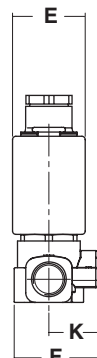
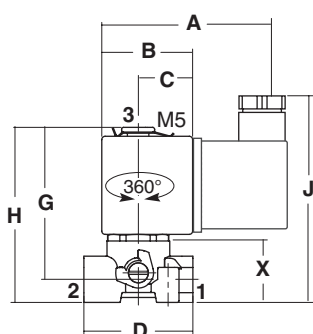
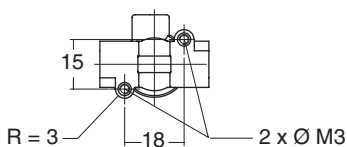

type	prefix option	pipe size	A	B	C	D	E	F	G	H	J	K	X	weight <sup>(1)</sup>	
														brass	stainless steel
01	SC	1/8	60,5	27,5	16,5	33	22	25,5	46	53	69	15	18,6	0,156	0,138
02	SC	1/4	76	38	23,3	40	29,7	28,5	48	57	79	15	23,4	0,232	0,229

<sup>(1)</sup> including coil and connector.

All leaflets are available on: [www.asco.com](http://www.asco.com)

**4 - Solenoid valves (3/2)**



# SCATTERGOOD & JOHNSON LTD

ELECTRICAL ENGINEERING & FLUID CONTROL DISTRIBUTORS

Est.1899

At Scattergood & Johnson Ltd, we pride ourselves on being a technical distributor to specialist industries.

Working with a range of quality product suppliers across a number of specialist markets, we are not your average 'box shifter' - we are your technical and supply chain partner.

We fully support every product we sell - for free! Our internal team and external sales engineers can answer any product or application question, no matter the complexity.

Backing up this technical ability is a range of 50,000+ products available from stock for nationwide next day delivery (same day if required!), or you can collect what you need from any of our trade counters around the UK.

Select your specialist interest below to learn more about how we can help.



Online, In Branch and On the Road - Scattergood & Johnson Ltd, there when you need us.

# [www.scatts.co.uk](http://www.scatts.co.uk)