

Wall mounted socket - Part no. 105

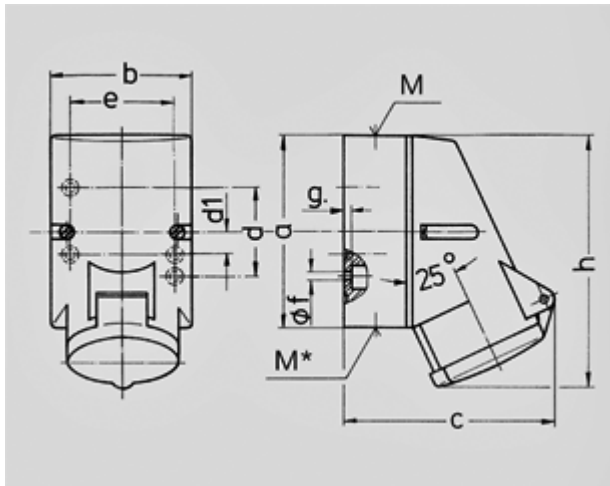

- screw terminals
- internal fixing
- one cable entry at top and one blind entry (can be cut out) at the bottom
- 4p and 5p sockets the enclosure can be turned 180°

Protection type	IP 44
Ampere	16A
Poles	4p
Voltage	400V
Hertz	50-60 Hz
Earth position	6h
Contact	standard
Connection technology	Screw terminals



Drawing	Amp.	16		
		Poles		
1 MB 209		3	4	5
Dim. in mm	a	87	100	100
	b	64	75	75
	c	99	110	113
	d	40	-	-
	d1	-	11	11
	e	50	59	59
	f	4,5	5	5
	g	4	4	4
	h	115	125	128
	M	20	20	20
	M*	M20 (blind) to be cut out		
Max. cable diam. (mm)		15	15	15
Terminal for cond. cross section (mm ²) min.-max.		1,5	1,5	1,5
		-4	-4	-4



SCATTERGOOD & JOHNSON LTD

ELECTRICAL ENGINEERING & FLUID CONTROL DISTRIBUTORS

Est.1899

At Scattergood & Johnson Ltd, we pride ourselves on being a technical distributor to specialist industries.

Working with a range of quality product suppliers across a number of specialist markets, we are not your average 'box shifter' - we are your technical and supply chain partner.

We fully support every product we sell - for free! Our internal team and external sales engineers can answer any product or application question, no matter the complexity.

Backing up this technical ability is a range of 50,000+ products available from stock for nationwide next day delivery (same day if required!), or you can collect what you need from any of our trade counters around the UK.

Select your specialist interest below to learn more about how we can help.



Online, In Branch and On the Road - Scattergood & Johnson Ltd, there when you need us.

www.scatts.co.uk