

**Plug AM-TOP® - Part no. 744**



- screw terminals
- highly heat resistant contact carrier
- nickel plated contacts
- single part body
- cable gland and sealing
- strain relief and protection against kinking

Protection type	IP 44
Ampere	32A
Poles	7p
Voltage	400V
Hertz	50-60 Hz
Earth position	6h
Contact	nickel plated contacts, highly heat resistant contact carrier
Connection technology	Screw terminals

Std. Pack. 10 Qty.

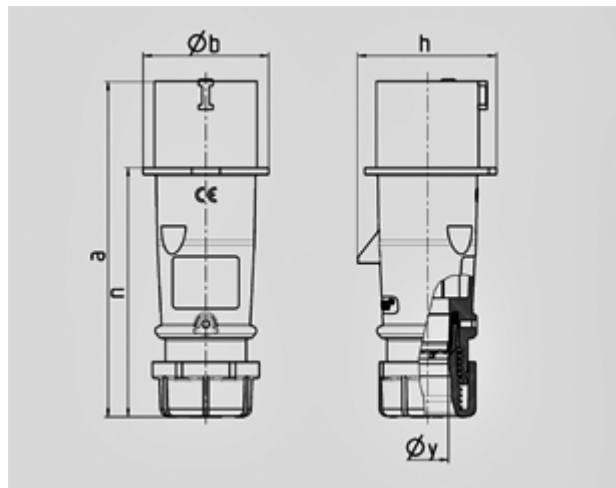

Drawing	Amp.	16		32	
		7		7	
2 MB 217	Poles				
Dim. in mm	a	147		180	
	b	67		77	
	h	76		89,5	
	n	110,5		135	
	y	16		22	
Terminal for cond. cross		1		2,5	
section (mm <sup>2</sup> ) min.-max.			-2,5		-6



# SCATTERGOOD & JOHNSON LTD

ELECTRICAL ENGINEERING & FLUID CONTROL DISTRIBUTORS

Est.1899

At Scattergood & Johnson Ltd, we pride ourselves on being a technical distributor to specialist industries.

Working with a range of quality product suppliers across a number of specialist markets, we are not your average 'box shifter' - we are your technical and supply chain partner.

We fully support every product we sell - for free! Our internal team and external sales engineers can answer any product or application question, no matter the complexity.

Backing up this technical ability is a range of 50,000+ products available from stock for nationwide next day delivery (same day if required!), or you can collect what you need from any of our trade counters around the UK.

Select your specialist interest below to learn more about how we can help.



Online, In Branch and On the Road - Scattergood & Johnson Ltd, there when you need us.

# [www.scatts.co.uk](http://www.scatts.co.uk)