

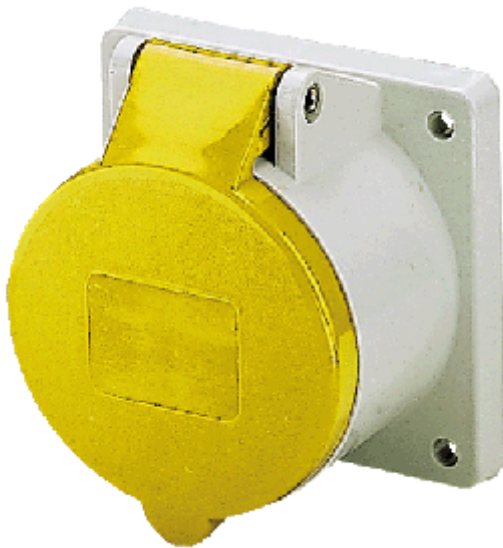

Panel mounted receptacle - Part no. 1365



- screw terminals
- straight

Protection type	IP 44
Ampere	16A
Poles	3p
Voltage	110V
Hertz	50-60 Hz
Earth position	4h
Contact	standard
Connection technology	Screw terminals

Std. Pack. 10 Qty.

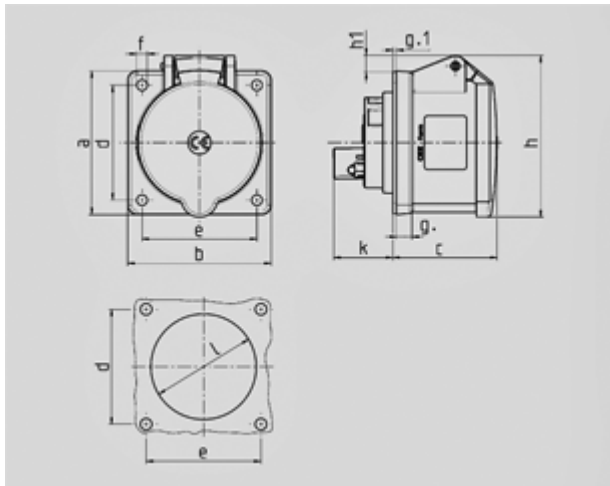

Drawing	Amp.	16			32		
		3	4	5	3	4	5
1 MB 247	Poles						
Dim. in mm	a	75	75	75	75	75	75
	b	75	75	75	75	75	75
	c	53	53	55	64	64	65
	d	60	60	60	60	60	60
	e	60	60	60	60	60	60
	f	5.5	5.5	5.5	5.5	5.5	5.5
	g.	8	8	8	8	8	8
	g.1	2	2	2	2	2	2
	h	75	80	83	89	89	100
	h1		6	8	11	11	12
	k	31	32	32	39	39	39
	l	43	52	54	58	58	62
	Terminal for cond. cross section (mm²) min.-max.	1.5	1.5	1.5	2.5	2.5	2.5
		-4	-4	-4	-10	-10	-10



SCATTERGOOD & JOHNSON LTD

ELECTRICAL ENGINEERING & FLUID CONTROL DISTRIBUTORS

Est.1899

At Scattergood & Johnson Ltd, we pride ourselves on being a technical distributor to specialist industries.

Working with a range of quality product suppliers across a number of specialist markets, we are not your average 'box shifter' - we are your technical and supply chain partner.

We fully support every product we sell - for free! Our internal team and external sales engineers can answer any product or application question, no matter the complexity.

Backing up this technical ability is a range of 50,000+ products available from stock for nationwide next day delivery (same day if required!), or you can collect what you need from any of our trade counters around the UK.

Select your specialist interest below to learn more about how we can help.



Online, In Branch and On the Road - Scattergood & Johnson Ltd, there when you need us.

www.scatts.co.uk