

Plug PowerTOP® - Part no. 3830



- screw terminals
- highly heat resistant contact carrier
- nickel plated contacts
- cable gland and external cable grip

Protection type	IP 67
Ampere	32A
Poles	3p
Voltage	230V
Hertz	50-60 Hz
Earth position	6h
Contact	nickel plated contacts, highly heat resistant contact carrier
Connection technology	Screw terminals

Std. Pack. 10 Qty.

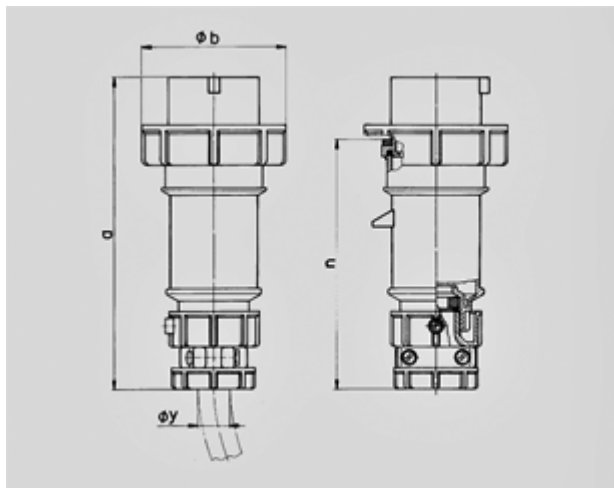

Drawing	Amp.	16			32		
		3	4	5	3	4	5
2 MB 171	Poles						
Dim. in mm	a	162	172	186	199	199	213
	b	71	79	89	95	95	102
	n	129	139	152	157	157	172
	y	19	19	22	24,5	24,5	28,5
Terminal for cond. cross		1	1	1	2,5	2,5	2,5
section (mm ²) min.-max.		-2,5	-2,5	-2,5	-6	-6	-6



SCATTERGOOD & JOHNSON LTD

ELECTRICAL ENGINEERING & FLUID CONTROL DISTRIBUTORS

Est.1899

At Scattergood & Johnson Ltd, we pride ourselves on being a technical distributor to specialist industries.

Working with a range of quality product suppliers across a number of specialist markets, we are not your average 'box shifter' - we are your technical and supply chain partner.

We fully support every product we sell - for free! Our internal team and external sales engineers can answer any product or application question, no matter the complexity.

Backing up this technical ability is a range of 50,000+ products available from stock for nationwide next day delivery (same day if required!), or you can collect what you need from any of our trade counters around the UK.

Select your specialist interest below to learn more about how we can help.



Online, In Branch and On the Road - Scattergood & Johnson Ltd, there when you need us.

www.scatts.co.uk