

Wall mounted receptacle - Part no. 7605



- screw terminals
- for horizontal installation
- switched
- mechanical DUO-interlock
- receptacles can be padlocked

Protection type	IP 44
Ampere	16A
Poles	4p
Voltage	400V
Hertz	50-60Hz
Earth position	6h
Contact	standard
Connection technology	Screw terminals

Std. Pack. 1 Qty.

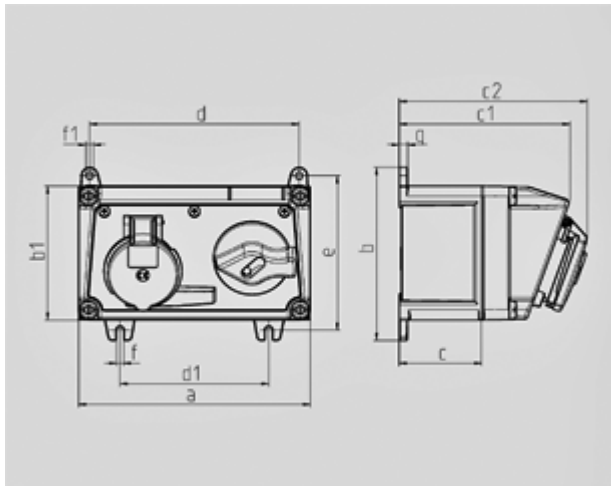

Drawing	Amp.	16			32		
		3	4	5	3	4	5
1 MB 550	Poles						
Dim. in mm	a	225	225	225	225	225	225
	b	168	168	168	168	168	168
	b1	130	130	130	130	130	130
	c	80	80	80	80	80	80
	c1	166	166	166	166	166	166
	c2	182	183	183	193	193	193
	d	204	204	204	204	204	204
	d1	145	145	145	145	145	145
	e	150	150	150	150	150	150
	f	7	7	7	7	7	7
	f1	Ø7	Ø7	Ø7	Ø7	Ø7	Ø7
	g	8	8	8	8	8	8



SCATTERGOOD & JOHNSON LTD

ELECTRICAL ENGINEERING & FLUID CONTROL DISTRIBUTORS

Est.1899

At Scattergood & Johnson Ltd, we pride ourselves on being a technical distributor to specialist industries.

Working with a range of quality product suppliers across a number of specialist markets, we are not your average 'box shifter' - we are your technical and supply chain partner.

We fully support every product we sell - for free! Our internal team and external sales engineers can answer any product or application question, no matter the complexity.

Backing up this technical ability is a range of 50,000+ products available from stock for nationwide next day delivery (same day if required!), or you can collect what you need from any of our trade counters around the UK.

Select your specialist interest below to learn more about how we can help.



Online, In Branch and On the Road - Scattergood & Johnson Ltd, there when you need us.

www.scatts.co.uk