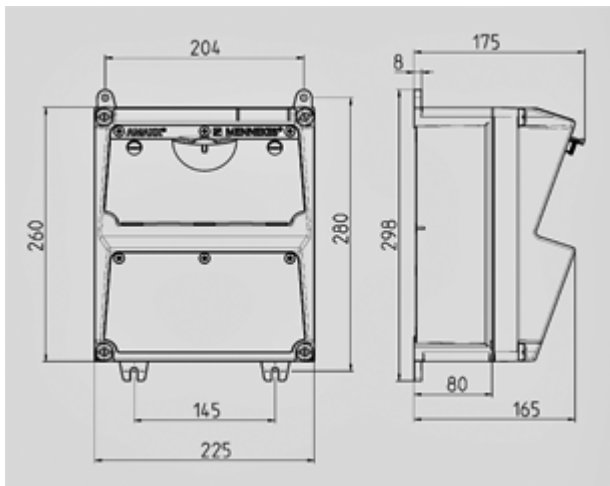

AMAXX® combination unit - Part no. 922517

- switched, with mechanical DUO-interlock, fused with 1 RCD 30mA

Protection type	IP 67
Fitted with	1 CEE 16A, 4p, 400V
Fusing	1 RCD 40A, 4p, 0.03A
Connection/feeder cable	for 1 cable up to 3 x 10 mm ²
Enclosure size	260 x 225 mm (H x W)
Ampere	16A
Poles	4p
Voltage	400V
Hertz	50-60Hz
Earth position	6h
Contact	standard
Connection technology	Screw terminals

Std. Pack. 1 Qty.

**Drawing 1 MB 521**

Depth dimensions at various fittings.

Sockets	Degrees	Depth
SCHUKO®16A, 230 V	IP 44	175 mm
	IP 67	194 mm
CEE 16A, 3p, 230V	IP 44	204 mm
	IP 67	205 mm
CEE 16A, 5p, 400V	IP 44	209 mm
	IP 67	213 mm
CEE 32A, 5p, 400V	IP 44	221 mm
	IP 67	227 mm
CEE 63A, 5p, 400V	IP 44	248 mm
	IP 67	248 mm



SCATTERGOOD & JOHNSON LTD

ELECTRICAL ENGINEERING & FLUID CONTROL DISTRIBUTORS

Est.1899

At Scattergood & Johnson Ltd, we pride ourselves on being a technical distributor to specialist industries.

Working with a range of quality product suppliers across a number of specialist markets, we are not your average 'box shifter' - we are your technical and supply chain partner.

We fully support every product we sell - for free! Our internal team and external sales engineers can answer any product or application question, no matter the complexity.

Backing up this technical ability is a range of 50,000+ products available from stock for nationwide next day delivery (same day if required!), or you can collect what you need from any of our trade counters around the UK.

Select your specialist interest below to learn more about how we can help.



Online, In Branch and On the Road - Scattergood & Johnson Ltd, there when you need us.

www.scatts.co.uk