

Panel mounted receptacle - Part no. 229A

- screw terminals
- straight

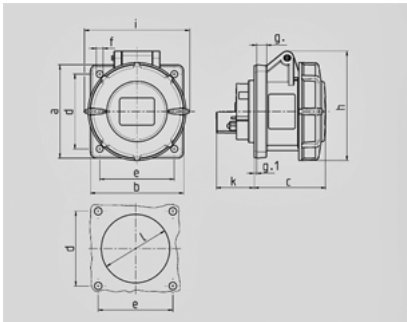

Technical information	
Ampere	32 A
Poles	3p
Voltage	110V
Earth position	4 h
Hertz	50-60 Hz
Connection technology	Screw terminals
Contact	standard
Protection type	IP 67



Drawing 1 MB 141	Amp. Poles	16			32		
		3	4	5	3	4	5
Dim. in mm	a	75	75	75	85	85	85
	b	75	75	75	75	75	75
	c	60	61	61	70	70	72
	d	60	60	60	60	60	60
	e	60	60	60	60	60	60
	f	5.5	5.5	5.5	5.5	5.5	5.5
	g.	8	8	8	8	8	8
	g.1	2	2	2	2	2	2
	h	83	88	95	99	99	105
	i	78	85	96	103	103	110
	k	31	32	32	39	39	39
	l	43	52	54	58	58	65
	Terminal for cond. cross section (mm ²) min.-max.	1.5	1.5	1.5	2.5	2.5	2.5
		-4	-4	-4	-10	-10	-10



SCATTERGOOD & JOHNSON LTD

ELECTRICAL ENGINEERING & FLUID CONTROL DISTRIBUTORS

Est.1899

At Scattergood & Johnson Ltd, we pride ourselves on being a technical distributor to specialist industries.

Working with a range of quality product suppliers across a number of specialist markets, we are not your average 'box shifter' - we are your technical and supply chain partner.

We fully support every product we sell - for free! Our internal team and external sales engineers can answer any product or application question, no matter the complexity.

Backing up this technical ability is a range of 50,000+ products available from stock for nationwide next day delivery (same day if required!), or you can collect what you need from any of our trade counters around the UK.

Select your specialist interest below to learn more about how we can help.



Online, In Branch and On the Road - Scattergood & Johnson Ltd, there when you need us.

www.scatts.co.uk