

Wall mounted socket - Part no. 7002A



- screw terminals
- switched
- mechanical DUO-interlock
- sockets can be padlocked

Protection type	IP 44
Ampere	16A
Poles	3p
Voltage	230V
Hertz	50-60 Hz
Earth position	6h
Contact	standard
Connection technology	Screw terminals

Std. Pack. 1 Qty.

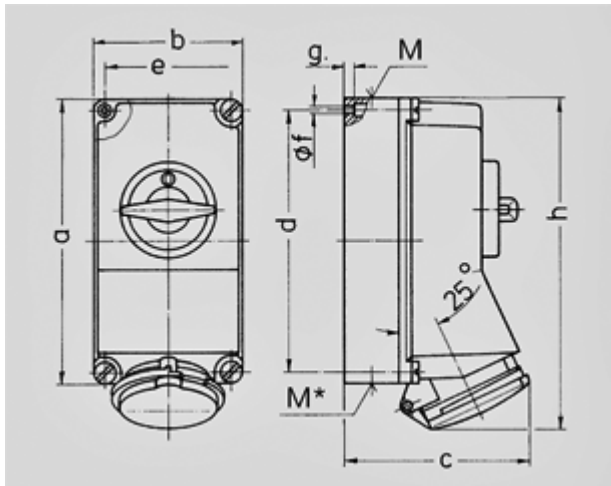

Drawing	Amp.	16			32		
		Poles			Poles		
1 MB 174		3	4	5	3	4	5
Dim. in mm	a	225	225	225	225	225	225
	b	118	118	118	118	118	118
	c	141	141	141	146	146	146
	d	208	208	208	208	208	208
	e	101	101	101	101	101	101
	f	6,3	6,3	6,3	6,3	6,3	6,3
	g	8	8	8	8	8	8
	h	250	252	254	264	264	264
	M	1x25 and 1x32			1x25 and 1x32		
	M*	2x25	2x25	2x25	2x25	2x25	2x25
	Max. cable diam. (mm)	25	25	25	25	25	25
	Terminal for cond. cross section (mm ²) min.-max.	1,5	1,5	1,5	2,5	2,5	2,5
		-4	-4	-4	-10	-10	-10



SCATTERGOOD & JOHNSON LTD

ELECTRICAL ENGINEERING & FLUID CONTROL DISTRIBUTORS

Est.1899

At Scattergood & Johnson Ltd, we pride ourselves on being a technical distributor to specialist industries.

Working with a range of quality product suppliers across a number of specialist markets, we are not your average 'box shifter' - we are your technical and supply chain partner.

We fully support every product we sell - for free! Our internal team and external sales engineers can answer any product or application question, no matter the complexity.

Backing up this technical ability is a range of 50,000+ products available from stock for nationwide next day delivery (same day if required!), or you can collect what you need from any of our trade counters around the UK.

Select your specialist interest below to learn more about how we can help.



Online, In Branch and On the Road - Scattergood & Johnson Ltd, there when you need us.

www.scatts.co.uk