

Wall mounted inlet - Part no. 357



- screw terminals
- for a suitable watertight protective cover see part no. 40434

Technical information

Ampere	63 A
Poles	4 p
Voltage	400V
Earth position	6 h
Hertz	50-60 Hz
Connection technology	Screw terminals
Contact	standard
Protection type	IP 67

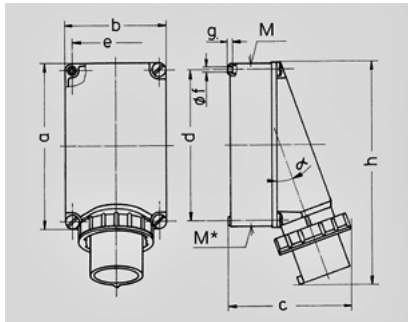

Drawing	Amp.	63			125	
		3	4	5	4	5
2 MB 36	Poles					
Dim. in mm	a	170	170	170	264	264
	b	118	118	118	163	163
	c	171	171	171	205	205
	d	136	136	136	240	240
	e	104	104	104	140	140
	f	6,1	6,1	6,1	8,1	8,1
	g	6	6	6	8	8
	h	250	250	250	355	355
	M	40	40	40	50	50
	M*	2x40	2x40	2x40	50	50
	a	25°	25°	25°	20°	20°
	Max. cable diam. (mm)	32	32	32	38	38
	Terminal for cond. cross section (mm ²) min.-max.	4	4	4	16	16
		-10	-10	-10	-35	-35



SCATTERGOOD & JOHNSON LTD

ELECTRICAL ENGINEERING & FLUID CONTROL DISTRIBUTORS

Est.1899

At Scattergood & Johnson Ltd, we pride ourselves on being a technical distributor to specialist industries.

Working with a range of quality product suppliers across a number of specialist markets, we are not your average 'box shifter' - we are your technical and supply chain partner.

We fully support every product we sell - for free! Our internal team and external sales engineers can answer any product or application question, no matter the complexity.

Backing up this technical ability is a range of 50,000+ products available from stock for nationwide next day delivery (same day if required!), or you can collect what you need from any of our trade counters around the UK.

Select your specialist interest below to learn more about how we can help.



Online, In Branch and On the Road - Scattergood & Johnson Ltd, there when you need us.

www.scatts.co.uk