

Wall mounted receptacle - Part no. 9382

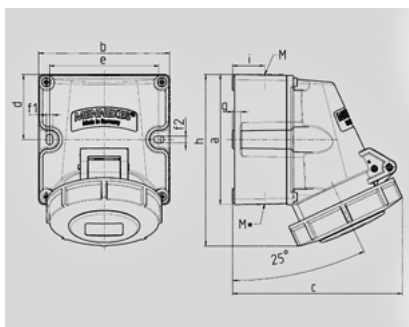

- screw terminals
- highly resistant to chemicals
- with 2 external fixing points
- enclosure base can be turned 180°
- receptacles are designed for adding an auxiliary contact switch

Technical information	
Ampere	32 A
Poles	5 p
Voltage	400V
Earth position	6 h
Hertz	50-60 Hz
Connection technology	Screw terminals
Contact	standard
Protection type	IP 67



Drawing 1 MB 622	Amp. Poles	16			32		
		3	4	5	3	4	5
Dim. in mm	a	100	100	100	100	100	100
	b	101	101	101	109	109	109
	c	117	125	131	157	157	160
	d	50	50	50	50	50	50
	e	84	84	84	92	92	92
	f1	5,3	5,3	5,3	5,3	5,3	5,3
	f2	5,3	5,3	5,3	5,3	5,3	5,3
	g	6,5	6,5	6,5	6,5	6,5	6,5
	h	131	131	132	148	148	148
	i	24,7	24,7	24,7	27,5	27,5	27,5
	M	25 (optional M20)			32 (optional M25)		
	M*	2x25 (blind) to be cut out 18 (M25) and 15 (M20)			2x25 (blind) to be cut out 25 (M32) and 18 (M25)		
	Max. cable diam. (mm)	1,5			2,5		
	Terminal for cond. cross section (mm ²) min.-max.	1,5 1,5 1,5			2,5 2,5 2,5		
		-4 -4 -4			-6 -6 -6		



SCATTERGOOD & JOHNSON LTD

ELECTRICAL ENGINEERING & FLUID CONTROL DISTRIBUTORS

Est.1899

At Scattergood & Johnson Ltd, we pride ourselves on being a technical distributor to specialist industries.

Working with a range of quality product suppliers across a number of specialist markets, we are not your average 'box shifter' - we are your technical and supply chain partner.

We fully support every product we sell - for free! Our internal team and external sales engineers can answer any product or application question, no matter the complexity.

Backing up this technical ability is a range of 50,000+ products available from stock for nationwide next day delivery (same day if required!), or you can collect what you need from any of our trade counters around the UK.

Select your specialist interest below to learn more about how we can help.



Online, In Branch and On the Road - Scattergood & Johnson Ltd, there when you need us.

www.scatts.co.uk