

Plug - SPDB 2,5/ 1-L - 3043190

Please be informed that the data shown in this PDF Document is generated from our Online Catalog. Please find the complete data in the user's documentation. Our General Terms of Use for Downloads are valid (<http://phoenixcontact.com/download>)



Plug, number of positions: 1, connection method: Spring-cage connection, cross section: 0.08 mm²- 4 mm², AWG: 28 - 12, nominal current: 24 A, nom. voltage: 500 V, width: 5.2 mm, color: gray

Product Description

Connector element left, left housing without engagement pin, right opened without cover

Your advantages

- Plug with bridging option, for use with basic terminal blocks
- The plug with spring-cage connection is assembled directly on site by snapping together single-position plug elements
- The ST-COMBI plugs for self-assembly provide solutions that users can implement themselves
- Tested for railway applications



Key Commercial Data

Packing unit	50 pc
Minimum order quantity	50 pc
GTIN	 4 017918 895051
GTIN	4017918895051
Weight per Piece (excluding packing)	4.907 g
Custom tariff number	85366990
Country of origin	Poland
Sales Key	BE2144

Technical data

General

Number of positions	1
Nominal cross section	2.5 mm ²
Color	gray
Insulating material	PA
Flammability rating according to UL 94	V0

Plug - SPDB 2,5/ 1-L - 3043190

Technical data

General

Rated surge voltage	6 kV
Degree of pollution	3
Overvoltage category	III
Insulating material group	I
Maximum power dissipation for nominal condition	0.77 W
Maximum load current	24 A (with 4 mm ² conductor cross section)
Nominal current I _N	24 A
Nominal voltage U _N	500 V
Relative insulation material temperature index (Elec., UL 746 B)	130 °C
Temperature index of insulation material (DIN EN 60216-1 (VDE 0304-21))	130 °C
Static insulating material application in cold	-60 °C
Surface flammability NFPA 130 (ASTM E 162)	passed
Specific optical density of smoke NFPA 130 (ASTM E 662)	passed
Calorimetric heat release NFPA 130 (ASTM E 1354)	28 MJ/kg
Smoke gas toxicity NFPA 130 (SMP 800C)	passed
Fire protection for rail vehicles (DIN EN 45545-2) R22	HL 1 - HL 3
Fire protection for rail vehicles (DIN EN 45545-2) R23	HL 1 - HL 3
Fire protection for rail vehicles (DIN EN 45545-2) R24	HL 1 - HL 3
Fire protection for rail vehicles (DIN EN 45545-2) R26	HL 1 - HL 3

Dimensions

Width	5.2 mm
Length	32.7 mm
Height	39 mm
	24 mm
Pitch	5.2 mm

Connection data

Connection method	Spring-cage connection
Stripping length	8 mm ... 10 mm
Connection in acc. with standard	IEC 61984
Conductor cross section solid min.	0.08 mm ²
Conductor cross section solid max.	4 mm ²
Conductor cross section AWG min.	28
Conductor cross section AWG max.	12
Conductor cross section flexible min.	0.08 mm ²
Conductor cross section flexible max.	2.5 mm ²
Min. AWG conductor cross section, flexible	28
Max. AWG conductor cross section, flexible	14
Conductor cross section flexible, with ferrule without plastic sleeve min.	0.14 mm ²
Conductor cross section flexible, with ferrule without plastic sleeve max.	2.5 mm ²

Plug - SPDB 2,5/ 1-L - 3043190

Technical data

Connection data

Conductor cross section flexible, with ferrule with plastic sleeve min.	0.14 mm ²
Conductor cross section flexible, with ferrule with plastic sleeve max.	2.5 mm ²
Two conductors with the same cross section, flexible, with TWIN ferrules, with plastic sleeve, maximum	0.5 mm ²
Internal cylindrical gage	A3

Ambient conditions

Operating temperature	-60 °C ... 105 °C (max. short-term operating temperature 130°C)
Ambient temperature (storage/transport)	-25 °C ... 60 °C (for a short time, not exceeding 24 h, -60 °C to +70 °C)
Permissible humidity (storage/transport)	30 % ... 70 %
Ambient temperature (assembly)	-5 °C ... 70 °C
Ambient temperature (actuation)	-5 °C ... 70 °C

Standards and Regulations

Connection in acc. with standard	CSA
	IEC 61984
Flammability rating according to UL 94	V0

Environmental Product Compliance

China RoHS	Environmentally friendly use period: unlimited = EFUP-e
	No hazardous substances above threshold values

Drawings

Circuit diagram



Diagram

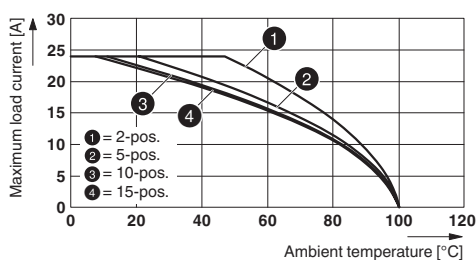

Derating curve for ST 2,5/ 1P, ST 2,5/ 2P, ST 2,5-TWIN/ 1P and for all plug versions SP...

Plug - SPDB 2,5/ 1-L - 3043190

Diagram

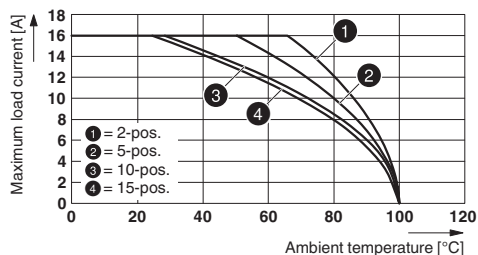

Derating curve for ST 2,5-TWIN-MT/1P, ST 2,5-TWIN-TG/1P and for all plug versions SP... .

Diagram

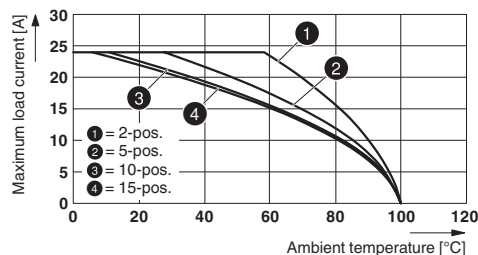

Derating curve for ST 2,5-QUATTRO/2P, ST 2,5-QUATTRO/4P and for all plug versions SP... .

Diagram

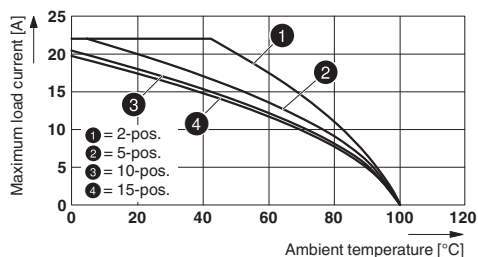

Derating curve for STTB 2,5/ 2P, STTB 2,5/ 2P-PV and for all plug versions SP... .

Diagram

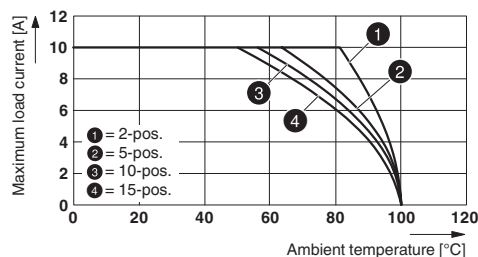

Derating curve for ST 2,5-4L/1P, ST 2,5-4L/2P and for all plug versions SP... .

Schematic diagram

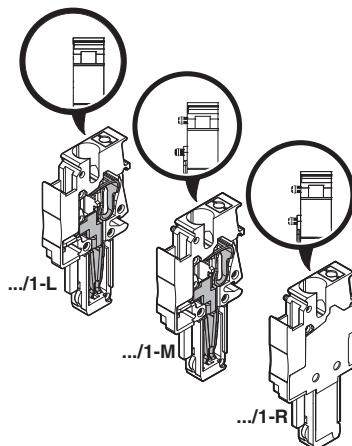

Classifications

eCl@ss

eCl@ss 10.0.1	27141151
eCl@ss 11.0	27141151
eCl@ss 4.0	27260700
eCl@ss 4.1	27260700

<https://www.phoenixcontact.com/gb/products/3043190>



Plug - SPDB 2,5/ 1-L - 3043190

Classifications

eCl@ss

eCl@ss 5.0	27260700
eCl@ss 5.1	27260700
eCl@ss 6.0	27141100
eCl@ss 7.0	27141151
eCl@ss 9.0	27141151

ETIM

ETIM 2.0	EC000897
ETIM 3.0	EC000897
ETIM 4.0	EC002021
ETIM 5.0	EC002021
ETIM 6.0	EC002021
ETIM 7.0	EC002021

UNSPSC

UNSPSC 6.01	30211802
UNSPSC 7.0901	39121402
UNSPSC 11	39121402
UNSPSC 12.01	39121402
UNSPSC 13.2	39121402
UNSPSC 18.0	39121402
UNSPSC 19.0	39121402
UNSPSC 20.0	39121402
UNSPSC 21.0	39121402

Approvals

Approvals

Approvals

DNV GL / CSA / BV / LR / UL Recognized / cUL Recognized / IECCE CB Scheme / EAC / RS / VDE Zeichengenehmigung / cULus Recognized

Ex Approvals

Approval details

DNV GL		https://approvalfinder.dnvgl.com/	TAE00001CS
--------	---	---	------------



Plug - SPDB 2,5/ 1-L - 3043190

Approvals

CSA		http://www.csagroup.org/services-industries/product-listing/	13631
-----	---	---	-------

	B	C	D
Nominal voltage UN	300 V	300 V	600 V
Nominal current IN	20 A	20 A	5 A
mm ² /AWG/kcmil	24-12	24-12	24-12

BV		http://www.veristar.com/portal/veristarinfo/generalinfo/approved/approvedProducts/equipmentAndMaterials	27721/B0 BV
----	---	---	-------------

LR		http://www.lr.org/en	LR2042068TA
----	---	---	-------------

UL Recognized		http://database.ul.com/cgi-bin/XYV/template/LISEXT/1FRAME/index.htm	FILE E 60425
---------------	---	---	--------------

	B	C	D
Nominal voltage UN	300 V	300 V	600 V
Nominal current IN	20 A	20 A	5 A
mm ² /AWG/kcmil	26-12	26-12	26-12

cUL Recognized		http://database.ul.com/cgi-bin/XYV/template/LISEXT/1FRAME/index.htm	FILE E 60425
----------------	---	---	--------------

	B	C	D
Nominal voltage UN	300 V	300 V	600 V
Nominal current IN	20 A	20 A	5 A
mm ² /AWG/kcmil	26-12	26-12	26-12

IECEE CB Scheme		http://www.iecee.org/	DE1-62736/B1/B2
-----------------	---	---	-----------------

EAC		RU C- DE.BL08.B.00511
-----	---	--------------------------

<https://www.phoenixcontact.com/gb/products/3043190>



Plug - SPDB 2,5/ 1-L - 3043190

Approvals

RS		http://www.rs-head.spb.ru/en/index.php	17.00013.272
----	---	---	--------------

VDE Zeichengenehmigung		http://www2.vde.com/de/Institut/Online-Service/VDE-gepruefteProdukte/Seiten/Online-Suche.aspx	40019518
Nominal voltage UN		500 V	
mm ² /AWG/kcmil		0.2-4	

cULus Recognized	
------------------	---

Phoenix Contact 2021 © - all rights reserved
<http://www.phoenixcontact.com>



SCATTERGOOD & JOHNSON LTD

ELECTRICAL ENGINEERING & FLUID CONTROL DISTRIBUTORS

Est.1899

At Scattergood & Johnson Ltd, we pride ourselves on being a technical distributor to specialist industries.

Working with a range of quality product suppliers across a number of specialist markets, we are not your average 'box shifter' - we are your technical and supply chain partner.

We fully support every product we sell - for free! Our internal team and external sales engineers can answer any product or application question, no matter the complexity.

Backing up this technical ability is a range of 50,000+ products available from stock for nationwide next day delivery (same day if required!), or you can collect what you need from any of our trade counters around the UK.

Select your specialist interest below to learn more about how we can help.



Online, In Branch and On the Road - Scattergood & Johnson Ltd, there when you need us.

www.scatts.co.uk