



S312A-4-L-4R / S312A-4-H-4R Line

Advanced Analog Indicators

4-Digits Display with 4 relay outputs

1. GENERAL SPECIFICATIONS

- Universal input: voltage, current, thermocouples, thermoresistors (2, 3 or 4 wires measurements), potentiometer.
- Programmable retransmission of the measured instantaneous value by the isolated analog output (voltage or active/passive current).
- Filter programmable at 20 levels to stabilise reading.
- Temperature measurement displayable in Celsius or Fahrenheit degrees.
- Cold junction compensation in case of thermocouple input.
- 4 Digits display.
- Four alarms are activable on the instantaneous input value (alarm type: maximum, minimum, automatically resettable or not).
- Alarms status visible through four leds on the frontal panel.
- Rs485 serial communication with MODBUS RTU protocol, maximum 32 nodes.
- Four relay outputs for alarms signalling.
- Easy navigation on the programming Menu by three buttons on the frontal panel.
- Quick configuration of the alarm thresholds by the Quick Alarms Menu.
- Disturbance Rejection at 50 and 60 Hz.
- Display contrast settable.
- Four relay output: default state for out3 and out4 are settable by internal jumper

2. TECHNICAL SPECIFICATIONS

Power Supply:	Code S312A-4-L-4R: 10-40 Vdc, 19-28 Vca 50-60 Hz, max 3 W. Code S312A-4-H-4R: 85-265 Vac 50-60 Hz, max 3 W.
Voltage Input:	0..10 V, input impedance: 100 k Ω Resolution: 10000 points.
Current Input:	0..20 mA, input impedance ~20 Ω Resolution: 10000 points.
Thermoresistor Input (RTD) PT100	2, 3 or 4 wires measurement, excitation current: 1,1 mA, resolution: 0,1 $^{\circ}$ C. Temperature Range : -150 $^{\circ}$ C..650 $^{\circ}$ C. Resistance Range: 20..350 Ω .
Thermocouple Input:	Type: J, K, R, S, T, B, E, N; resolution: 10 μ V . Refer to the TABLE: TC RANGE for the measurement range.
Potentiometer Input:	Excitation Current: 1,1 mA. Potentiometer value from 1 k Ω to 100 k Ω , to use always with a parallel resistor equal to 330 Ω .
Analog Output:	Generated Current: 0..20 mA, max load resistance: 500 Ω . Voltage: 0..10 V, min load resistance: 1 k Ω . Configurable Start and Full scale values. Resolution: 2 μ A/ 1 mV.

Relay output:	Capacity:5 A/ 250 Vac.			
Sampling Frequency:	Fixed: 2 Hz.			
Response Time:	700 ms.			
Environmental Conditions:	Temperature: -10..60°C, Humidity min: 30%, max 90% at 40°C non-condensing.			
Errors referred to max measuring range:	Calibration Error	Thermal Coefficient	Linearity error	Others
Voltage/Current Input:	0,1%	0,01%/°K	0,05%	EMI (2):<1%
Input for thermocouples: J,K,E,T,N:	0,1%	0,01%/°K	0,5 °C	EMI (2): <1%
Input for Thermocouples: R,S:	0,1%	0,01%/°K	1 °C	EMI (2): <1%
Input for Thermocouples: B :	0,1%	0,01%/°K	2 °C	EMI (2): <1%
Cold junction compens.:	" 1,5 °C			
Potentiometer :	0,1%	0,01%/°K	0,1%	EMI (2): <1%
Thermoresistor Input :	0,1%	0,01%/°K	0,2%	EMI (2): <1%
Voltage/Current Output :	0,1%	0,01%/°K	0,05%	EMI (2): <1%
Isolation :	1500 V among each pair of ports			
Connections :	-Removable screw terminals, pitch 3,5 mm / 5,08 mm. -Three buttons for menu navigation.			
Protection Degree :	IP65 (on the frontal panel with the provided seal)			
Dimensions (L x W x H)	98,2 x 88,5 x 48 mm			
Standards	<p>EN61000-6-4/2002-10 (electromagnetic emission, industrial environment).</p> <p>EN61000-6-2/2006-10 (electromagnetic immunity, industrial environment).</p> <p>EN61010-1/2001 (safety).</p> <p>All circuits must be isolated from the other circuits under dangerous voltage with double isolation. The power supply transformer must comply with EN60742: "Isolated transformers and safety transformers".</p>			
				

Table: TC Range

TC TYPE	Admitted Range	TC TYPE	Admitted Range
J	-210..1200 °C	S	-50..1768 °C
K	-200..1372 °C	R	-50..1768 °C
E	-200..1000 °C	B	250..1820 (3) °C
N	-200..1300 °C	T	-200..400 °C

(2) EMI: electromagnetic interferences.

(3) Up to 250 °C, the output is considered equivalent to a null temperature.

3. RELAYS AND JUMPER POSITION

To extract the boards from S312A box:

- 1) remove the screw terminals from rear panel
- 2) press inwards the box on the top panel (where there is the serigraphy) and, at the same time, press inwards the box on the bottom panel
- 3) extract the display indicator
- 4) extract the boards from box.

Boards are as in the following figure.

*NOTE: **DEFAULT: N.O.** means «**NORMALLY OPEN**»

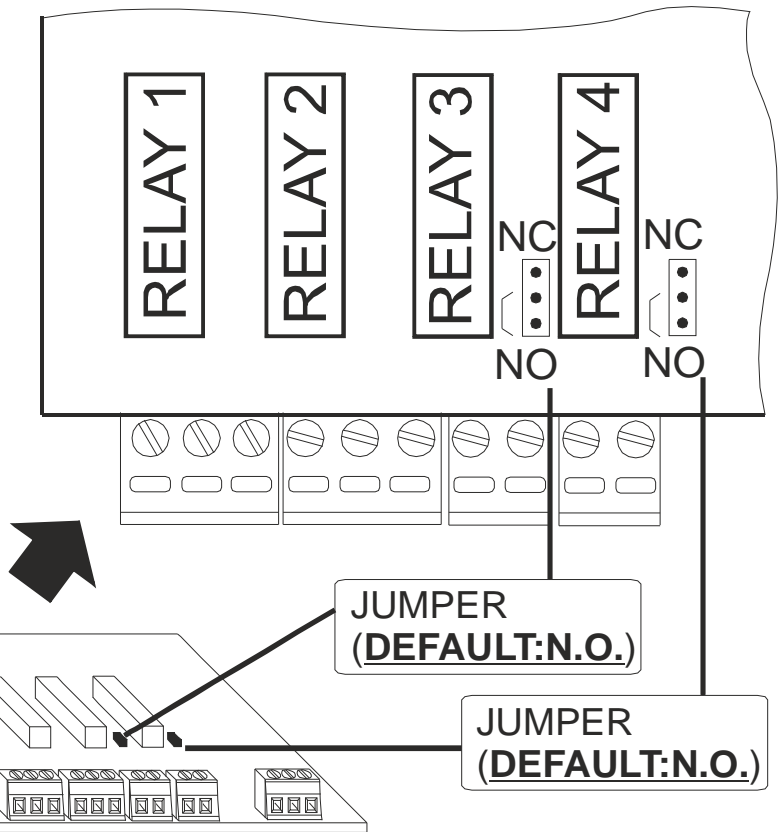

4. FUNCTIONING DESCRIPTION

The measured or integrated input value is translated into an analog output signal.

The instantaneous measurement of the input is displayed. The values are also available via Modbus RTU protocol upon query by RS485 bus.

4.1 Setting Modalities

All the parameters of the instrument may be set by the programming Menu or RS485. The alarms thresholds may be quickly set by the *Quick Alarm Menu*. Besides the software has been developed for the programming and the configuration of the module (consult the web site www.seneca.it).

4.2 Retransmission Modalities

The instrument allows the following retransmission modalities:

Analog Output: The measured input value is translated into an analog output signal (voltage or current).

4.3 Alarms on the Analog input

Four alarms may be activated on the instantaneous value of the input. Each alarm may be set on the following way:

- 1) Alarm on the minimum threshold.
- 2) Alarm on the maximum threshold.
- 3) Retained Alarm on the minimum threshold (the reset is not automatic).
- 4) Retained Alarm on the maximum threshold (the reset is not automatic).

For each alarm, it is possible to set Threshold and Hysteresis. If the alarm is set as high, the alarm will turn OFF when the input value is Threshold-Hysteresis; instead if the alarm is set as low, the alarm condition will end when if the input value is Threshold+Hysteresis. The alarms status is displayed by four leds on the frontal panel and by the relays. The relays toggle at the alarm condition and return to the initial status at the end of the alarm condition or at the reset (if retained). The retained alarms are reset by pressing the buttons **UP + OK/MENU** for some seconds (on normal view functioning).

4.4 Password for access to the menu

It is possible to enable the protection of the Programming Menu by password.

The Quick Alarm Menu is instead password free.

5. BUTTONS AND TERMINALS POSITION

FRONTAL PANEL: BUTTONS AND LEDS

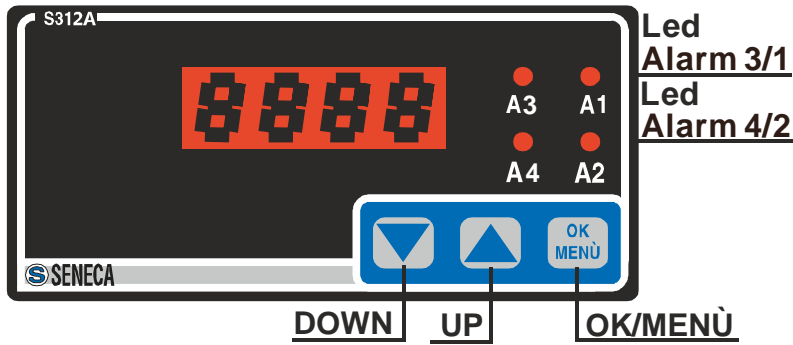

REAR SIDE: TERMINALS

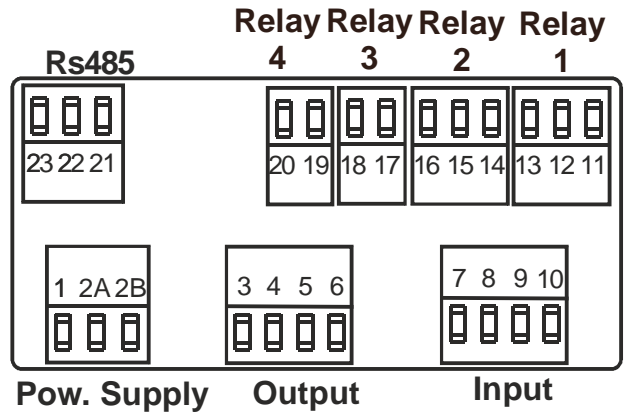

6. ELECTRICAL CONNECTIONS

POWER SUPPLY: Verify the code on the applied label.

Code S312A-4-L-4R

Code S312A-4-H-4R

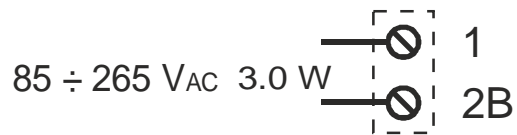

CURRENT INPUT

mA input

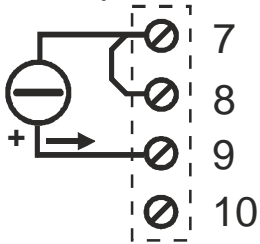

The loop is powered by the sensor

mA input (2 wires)

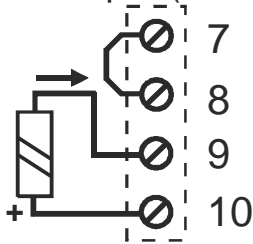

The loop is powered by the module (17 V Loop)

VOLTAGE INPUT

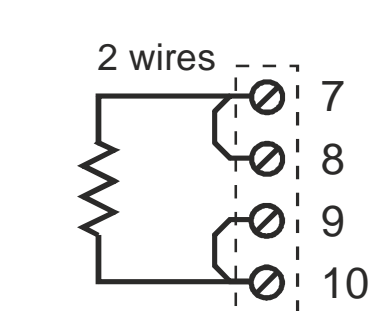
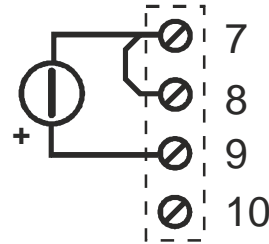

THERMOCOUPLE INPUT

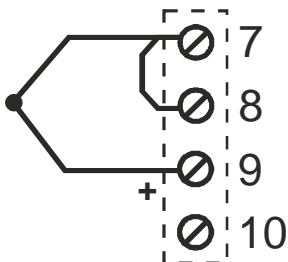

PT100 INPUT

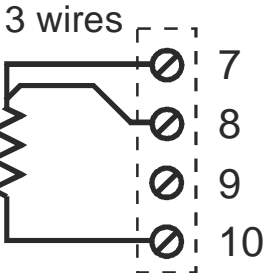

POTENTIOMETER INPUT

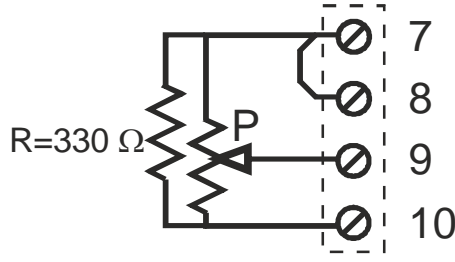

Resistance R=330 Ω (not provided),
P=1 kΩ ÷ 100 kΩ

ANALOG OUTPUT

Voltage

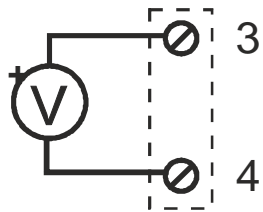

Generated Current

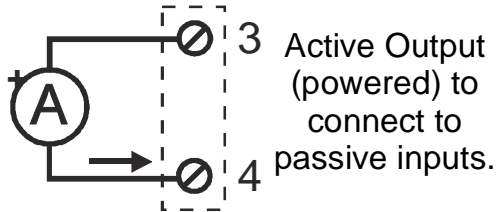

Ext. Power Supply Current

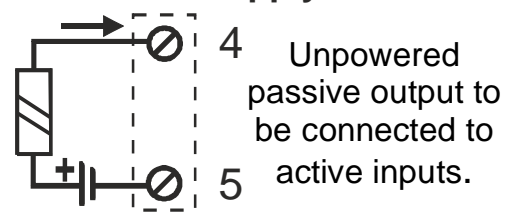

RELAY OUTPUT

RS485

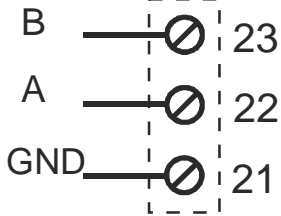

Relay Output 1 (5 A/250 Vac)

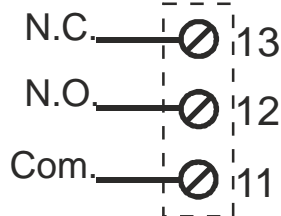

Relay Output 2 (5 A/250 Vac)

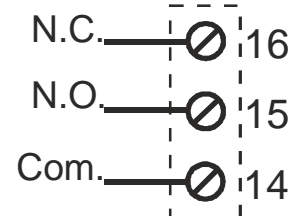

Relay Output 3 (5 A/250 Vac)

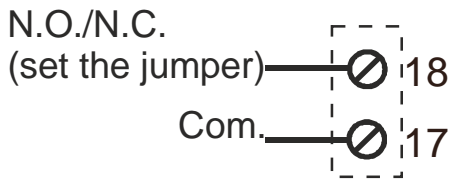

Default: N.O. normally open

Relay Output 4 (5 A/250 Vac)

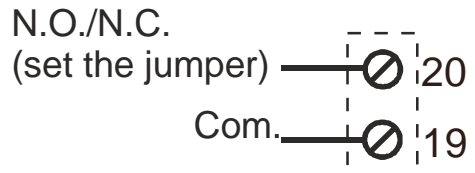

Default: N.O. normally open

7. MENU'S PARAMETERS

Parameters settable from Menu : **C.O.n.F.**

Parameter Symbol	Parameter Name	Description and setting range	Default Value
PASS	Enables the Password for the access to menu	Setting a value different from 5477, the password (always 5477) will be required at the start of the menu.	5477: Password disabled

Parameters settable from Menu : **I.n.P.t.**

Parameter Symbol	Parameter Name	Description and setting range	Default Value
TYPE	Input Type	1 = Voltage 6 = TCR 11 = TCN 2 = Current 7 = TCS 12 = PT100 (2 wires) 3 = Potentiometer 8 = TCT 13 = PT100 (3 wires) 4 = TC J 9 = TC B 14 = PT100 (4 wires) 5 = TC K 10 = TCE	2: Current

LO-E	Electrical Start Scale Value	Only for input type 1, 2 and 3. Start scale in V (voltage input) or mA (current input) or % (potentiometer). It defines also the value of the input signal associated to the minimum value of view (LO-d). Settable Values Values included between the minimum and maximum limits specified for the selected input type. Minimum Value: 0, Maximum Value: 99,99.	4,00 (mA)
HI-E	Electrical Full Scale value	Only for input type 1, 2 and 3. Full scale in V (voltage input) or mA (current input) or % (potentiometer). It defines also the value of the input signal associated to the maximum value of view (HI-d). Settable Values Values included between the minimum and maximum limits specified for the selected input type. Minimum Value: 0, Maximum Value: 99,99.	20,00 (mA)

Parameters settable from Menu : **S.C.A.L.**

Parameter Symbol	Parameter Name	Description and setting range	Default Value						
LO-d	Start scale of instantaneous view	Only for inputs 1, 2 and 3. Integer values between the following limits:	0						
		<table border="1"> <thead> <tr> <th>Display Digits Number</th> <th>Min. Limit</th> <th>Max. Limit</th> </tr> </thead> <tbody> <tr> <td>4</td> <td>-1999</td> <td>9999</td> </tr> </tbody> </table>	Display Digits Number	Min. Limit	Max. Limit	4	-1999	9999	
Display Digits Number	Min. Limit	Max. Limit							
4	-1999	9999							
HI-d	Full scale of instantaneous view		1000						
dp	Decimal Point position on the instantaneous view	Inputs 1, 2 and 3 0 = no decimal point (ex 1234), 1 = first digit (es 123.4) N display digit-1 Temperature Measurement 0 = resolution: °C (°F). 1 = resolution: °C/10 (°F/10).	0 = No decimal point						
FAHr	Temperature measurement in °C or °F	0 = Celsius degrees. 1 = Fahrenheit degrees.	0 = °C						
FLt	Filter Level	0 = no filter 1 ... 20	0 = No filter						

Parameters settable from Menues :

A.L.1. . A.L.2. . A.L.3. . A.L.4. .

Alarm 1 parameters: accessible from *A.L.1* menu and identified by the final index 1.Alarm 2 parameters: accessible from *A.L.2* menu and identified by the final index 2.Alarm 3 parameters: accessible from *A.L.3* menu and identified by the final index 3.Alarm 4 parameters: accessible from *A.L.4* menu and identified by the final index 4.

Parameter Symbol	Parameter Name	Description and setting range	Default Value						
SEt1	Alarm 1 Threshold	Value referred to the displayed value (decimal point set by <i>dP</i>).	1000						
SEt2	Alarm 2 Threshold	Temperature input: value expressed as set by <i>FAHr</i> (°C or °F).	1000						
HY51	Alarm 1 Hysteresys	Settable value on the following ranges:	10						
HY52	Alarm 2 Hysteresys		10						
		<table border="1"> <thead> <tr> <th>Display Digits Number</th> <th>Min. Limit</th> <th>Max. Limit</th> </tr> </thead> <tbody> <tr> <td>4</td> <td>-1999</td> <td>9999</td> </tr> </tbody> </table>	Display Digits Number	Min. Limit	Max. Limit	4	-1999	9999	
Display Digits Number	Min. Limit	Max. Limit							
4	-1999	9999							
TYP1	Alarm 1 Type	0 = Alarm disabled 1 = Alarm on the minimum threshold	0: AI 1 disabled						
TYP2	Alarm 2 Type	2 = Alarm on the maximum threshold 3 = Retained alarm on the minimum threshold (the reset is not automatic) 4 = Retained alarm on the maximum threshold (the reset is not automatic)	0: AI 2 disabled						
RLY1	Relay 1: N.O./N.C.	Relay Functioning: 0 = relay normally opened (N.O.)	0: N.O.						
RLY2	Relay 2: N.O./N.C.	1 = relay normally closed (N.C.).	0: N.O.						
SEt3	Alarm 3 Threshold	Value referred to the displayed value (decimal point set by <i>dP</i>).	1000						
SEt4	Alarm 4 Threshold	Temperature input: value expressed as set by <i>FAHr</i> (°C or °F).	1000						
HY53	Alarm 3 Hysteresys	Settable value on the following ranges:	10						
HY54	Alarm 4 Hysteresys		10						
		<table border="1"> <thead> <tr> <th>Display Digits Number</th> <th>Min. Limit</th> <th>Max. Limit</th> </tr> </thead> <tbody> <tr> <td>4</td> <td>-1999</td> <td>9999</td> </tr> </tbody> </table>	Display Digits Number	Min. Limit	Max. Limit	4	-1999	9999	
Display Digits Number	Min. Limit	Max. Limit							
4	-1999	9999							
TYP3	Alarm 3 Type	0 = Alarm disabled 1 = Alarm on the minimum threshold	0: AI 3 disabled						
TYP4	Alarm 4 Type	2 = Alarm on the maximum threshold 3 = Retained alarm on the minimum threshold (the reset is not automatic) 4 = Retained alarm on the maximum threshold (the reset is not automatic)	0: AI 4 disabled						
RLY3	Relay 3: N.O./N.C.	Relay Functioning: 0 = relay normally opened (N.O.)	0: N.O.						
RLY4	Relay 4: N.O./N.C.	1 = relay normally closed (N.C.).	0: N.O.						

Parameters settable from Menu : **0.U.E..**

Parameter Symbol	Parameter Name	Description and setting range	Default Value						
LO-t	Instantaneous display value associated to the minimum value of the output.	Limits for the scaling of the retransmitted output. Decimal point set by dP . Settable values on the following limits:	0						
HI-t	Instantaneous display value associated to the maximum value of the output.	<table border="1"> <thead> <tr> <th>Display Digits Number</th> <th>Min. Limit</th> <th>Max. Limit</th> </tr> </thead> <tbody> <tr> <td>4</td> <td>-1999</td> <td>9999</td> </tr> </tbody> </table>	Display Digits Number	Min. Limit	Max. Limit	4	-1999	9999	1000
Display Digits Number	Min. Limit	Max. Limit							
4	-1999	9999							
TYPE	Retransmitted output type	1 = 0..10 V 2 = 4..20 mA 3 = 0..20 mA	2: 4..20 mA						

Parameters settable from Menu : **6.U.5..**

Parameter Symbol	Parameter Name	Description and setting range	Default Value
Addr	MODBUS Address	Settable Values: from 1 to 255.	1
PAR	Parity control	0 = None 1 = Even 2 = Odd.	0: None
dEL	Delay of the response	Number of pauses of 6 characters each to be entered between the end of the Rx message and the start of the Tx. Settable value: 0..255.	0: No Delay
BAUD	Serial communication speed	Serial communication speed in baud: 0 = 4800 3 = 38400 6 = 1200 1 = 9600 4 = 57600 7 = 2400 2 = 19200 5 = 115200 8 = 14400	3: 38400

Parameters settable from Menu : **5.Y.5..**

Parameter Symbol	Parameter Name	Description and setting range	Default Value
COnt	Display Contrast	Values : 1 (minimum contrast) to 20 (maximum).	10
buFn	Behavior in case of Burn out (with PT100 or TC)	0 = Full scale value indication 1 = Start scale value indication If the value is set to full scale, also the retransmitted output goes to the 100% (0% if the value is set to the start scale) and the maximum (minimum) alarms are activated.	0: Full scale Indicat.
dFLt	Default Settings	1 = Overwrite the set values with the default values.	

E.H.I.t.By confirming with **OK/MENU** all the parametes are saved in flash memory and after some instants the module is reset.

8. ERROR SIGNALLINGS

The errors are directly viewed through display.

We are going to list all the possible signallings with the correspondent meaning:

nnnn: Instantaneous value to display $> Hl - d$ value of the 2.5% or if the instantaneous value $>$ maximum displayable.

UUUU: Instantaneous value to display $< Ll - d$ value of the 2.5% or instantaneous value to display $<$ minimum displayable.

bUrr: Burn-out of the temperature sensor.

SErr: communication error with the cold junction thermometer.

EErr: at the start may signal an error on the calibration memory. The functioning of the module is blocked while the Modbus communication is available.

9. ORDER CODES

Code		Description
Model	S312A	Indicator with universal analog input, 4 relays.
Display	-4	4 digits
Power Supply	-H	85..265 V _{AC}
	-L	10..40 V _{DC} / 19..28 V _{AC}
Output relay	-4R	4 output relay
Options	/T	Calibration and configuration Service

10. MODBUS REGISTERS

The S312A-4-L-4R and S312A-4-H-4R lines indicators have MODBUS 16 bits (words) registers, accessible by RS485 serial communication.

10.1 Supported MODBUS Commands

Code	Function	Description
03	Read Holding Registers	Reading of word registers up to 16 at a time.
06	Write Single Register	Writing of a word register.
16	Write Multiple Registers	Writing of word registers up to 16 at a time.

10.2 Holding Registers

The 16-bit Holding Registers have the following structure:

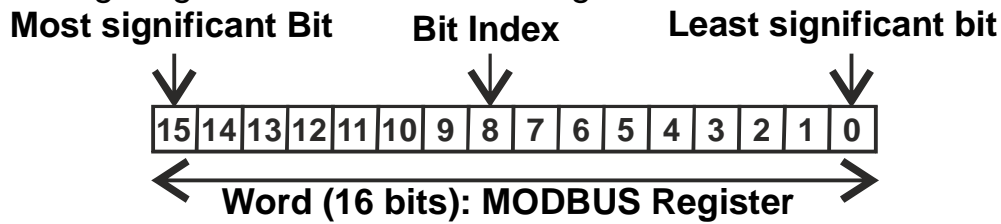

In the table the notation Bit [x:y] indicates all bits from x to y. For example Bit [2:1] indicates bit 2 and bit 1, and serves to illustrate the meaning of the various united combinations of the values of the two bits. Default values are indicated with the * symbol.

REGISTER	Description	ADDR	R/W
MACHINE ID	Bit [15:8]: contain the module's ID: 70. Bit [7:0]: contain the firmware's revision.	40001	R
FW_CODE	Register containing the internal code of the firmware.	40002	R
TYP_INP_CEL_FAHR	Register for the setting of the input type and of the temperature measure unit.	40003	R/W
Bit [15:8]	Set the input type: 1 : Voltage, 2* : Current 3 : Potentiometer, 4 : Thermocouple J 5 : Thermocouple K, 6 : Thermocouple R 7 : Thermocouple S, 8 : Thermocouple T 9 : Thermocouple B, 10 : Thermocouple E 11 : Thermocouple N, 12 : PT100 (2 wires) 13 : PT100 (3 wires), 14 : PT100 (4 wires)		
Bit [7:1]	Not used		
Bit 0	Temperature in Celsius or Fahrenheit degrees: 0* : Celsius 1 : Fahrenheit		
HI_E	Electrical Full Scale of the input in V/100, mA/100 or %/100	40004	R/W
Bit [15:0]	Full scale in Volt/100, mA/100 or %/100 respectively for input types 1, 2 and 3. This value must be included between the minimum and maximum specified for each input. Besides this parameter defines the value of the input signal associated to the maximum instantaneous value of view: HI_D. Min : 0, Max: 9999. Default: 2000.		
LO_E	Electrical Start Scale of the input in V/100, mA/100 or %/100	40005	R/W
Bit [15:0]	Start scale in Volt/100, mA/100 or %/100 respectively for input types 1, 2 and 3. This value must be included between the minimum and maximum specified for each input. Besides this parameter defines the value of the input signal associated to the minimum instantaneous value of view: LO_D. Min : 0, Max: 9999. Default: 400.		

DP/FILTER	<u>Decimal point position.</u>	40006	R/W
Bit [15:8]	Decimal point position: 0* = decimal point absent (ex. 1234) , 1 = first digit (ex 123.4), 2 = second digit,, N display digits-1. For temperature measurements: 0: °C (°F) resolution, 1: °C/10 (°F/10) resolution.		
Bit [7:0]	Set the filter level. Admitted values: 0* = no filter, 1 ..20.		
TYP_AL1/RLY1	<u>Sets the normal status of relay 1 and alarm 1 type.</u>	40007	R/W
Bit [15:8]	Set the Alarm 1 functioning: 0* = Alarm disabled 1 = Alarm on the minimum threshold 2 = Alarm on the maximum threshold 3 = Retained alarm on the minimum threshold (reset is not automatic) 4 = Retained alarm on the maximum threshold (reset is not automatic)		
Bit [7:1]	Not used		
Bit 0	Sets the relay 1 functioning: 0* = normally opened 1 = normally closed		
TYP_AL2/RLY2	<u>Sets the normal status of relay 2 and alarm 2 type.</u>	40008	R/W
Bit [15:8]	Set the Alarm 2 functioning: 0* = Alarm disabled 1 = Alarm on the minimum threshold 2 = Alarm on the maximum threshold 3 = Retained alarm on the minimum threshold (reset is not automatic) 4 = Retained alarm on the maximum threshold (reset is not automatic)		
Bit [7:1]	Not used		
Bit 0	Sets the relay 2 functioning: 0* = normally opened 1 = normally closed		

TYP_AL3/RLY3	<u>Sets the normal status of relay 3 and alarm 3 type.</u>	40009	R/W
Bit [15:8]	Set the Alarm 3 functioning: 0* = Alarm disabled 1 = Alarm on the minimum threshold 2 = Alarm on the maximum threshold 3 = Retained alarm on the minimum threshold (reset is not automatic) 4 = Retained alarm on the maximum threshold (reset is not automatic)		
Bit [7:1]	Not used		
Bit 0	Sets the relay 3 functioning: 0* = normally opened 1 = normally closed		
TYP_AL4/RLY4	<u>Sets the normal status of relay 4 and alarm 4 type.</u>	40010	R/W
Bit [15:8]	Set the Alarm 4 functioning: 0* = Alarm disabled 1 = Alarm on the minimum threshold 2 = Alarm on the maximum threshold 3 = Retained alarm on the minimum threshold (reset is not automatic) 4 = Retained alarm on the maximum threshold (reset is not automatic)		
Bit [7:1]	Not used		
Bit 0	Sets the relay 4 functioning: 0* = normally opened 1 = normally closed		
PASSWORD	<u>Enables / disables the password for the access to the programming menu.</u>	40011	R/W
Bit [15:0]	By setting a value different from 5477 , at the start of the programming menu the password (always 5477) will be required. Default: 5477.		
TYP_OUT/BURN	<u>Sets the behavior in case of Burn Out (PT100 or TC) and output type</u>	40012	R/W
Bit [15:8]	Set the retransmitted output type: 1 = 0..10 V output 2* = 4..20 mA output 3 = 0..20 mA output		
Bit [7:1]	Not used		
Bit 0	<i>Behavior in case of PT100 or Thermocouple Burn out.</i> 0* = Full scale indication 1 = Start scale indication.		

CONTRAST	<u>Display contrast</u>	40013	R/W
Bit [15:8]	Set the display contrast: values from 1 (minimum contrast) to 20 (maximum contrast). Default: 10.		
Bit [7:0]	Not used		
SET1	<u>Alarm 1 Threshold</u>	40014	R/W
Bit [15:0]	Alarm 1 threshold: value referred to the view scale but without decimal point. For example if the value referred to the view scale is 20,0 sets 200. See HI_T for parameter limits. Default: 1000.		
HYS1	<u>Alarm 1 Hysteresis</u>	40015	R/W
Bit [15:0]	Alarm 1 hysteresis: value referred to the view scale but without decimal point. For example if the value referred to the view scale is 10,00 sets 1000. See HI_T for parameter limits. Default: 10.		
SET2	<u>Alarm 2 Threshold</u>	40016	R/W
Bit [15:0]	Alarm 2 threshold: value referred to the view scale but without decimal point. For example if the value referred to the view scale is 20,0 sets 200. See HI_T for parameter limits. Default: 1000.		
HYS2	<u>Alarm 2 Hysteresis</u>	40017	R/W
Bit [15:0]	Alarm 2 hysteresis: value referred to the view scale but without decimal point. For example if the value referred to the view scale is 10,00 sets 1000. See HI_T for parameter limits. Default: 10.		
SET3	<u>Alarm 3 Threshold</u>	40018	R/W
Bit [15:0]	Alarm 3 threshold: value referred to the view scale but without decimal point. For example if the value referred to the view scale is 20,0 sets 200. See HI_T for parameter limits. Default: 1000.		
HYS3	<u>Alarm 3 Hysteresis</u>	40019	R/W
Bit [15:0]	Alarm 3 hysteresis: value referred to the view scale but without decimal point. For example if the value referred to the view scale is 10,00 sets 1000. See HI_T for parameter limits. Default: 10.		

SET4	<u>Alarm 4 Threshold</u>	40020	R/W
Bit [15:0]	Alarm 4 threshold: value referred to the view scale but without decimal point. For example if the value referred to the view scale is 20,0 sets 200. See HI_T for parameter limits. Default: 1000.		
HYS4	<u>Alarm 4 Hysteresis</u>	40021	R/W
Bit [15:0]	Alarm 4 hysteresis: value referred to the view scale but without decimal point. For example if the value referred to the view scale is 10,00 sets 1000. See HI_T for parameter limits. Default: 10.		
HI_T	<u>Displayed value correspondent to the maximum value of the analog output</u>	40022	R/W
Bit [15:0]	Displayed input value corresponding to retransmitted output maximum value. Set the value referred to the view scale but without decimal point. Example: if the value referred to the view scale is 10,0, set 100. Default: 1000. Min value: -1999 Max value: 9999		
LO_T	<u>Displayed value correspondent to the minimum value of the analog output</u>	40023	R/W
Bit [15:0]	Displayed input value corresponding to retransmitted output minimum value. Set the value referred to the view scale but without decimal point. Example: if the value referred to the view scale is 10,0, set 100. Default: 0. Min. and Max value: see HI_T		
HI_D	<u>Full Scale value of instantenous view</u>	40024	R/W
Bit [15:0]	Set the full scale value of the view scale. Only for input 1, 2 and 3. The decimal point on the set integer value is given by dP . Default: 1000. Min and max values: see HI_T .		
LO_D	<u>Start Scale value of instantenous view</u>	40025	R/W
Bit [15:0]	Set the start scale value of the view scale. Only for input 1, 2 and 3. The decimal point on the set integer value is given by dP . Default: 0. Limits value: see HI_T .		

mV_TC_FL_MSW	<u>Voltage in mV read from the thermocouple (Floating point, most significant word).</u>	40074	R
mV_TC_FL_LSW	<u>Voltage in mV read from the thermocouple (Floating point, least significant word).</u>	40075	R
TEMP_TC_FL_MSW	<u>Temperature in °C read from the thermocouple (Floating point, most significant word).</u>	40076	R
TEMP_TC_FL_LSW	<u>Temperature in °C read from the thermocouple (Floating point, least significant word).</u>	40077	R
TEMP_CJ_SHORT	<u>Cold junction temperature in 1/256 of °C.</u>	40078	R
Rx_FLOAT_MSW	<u>Resistance in Ohm if PT100 (Floating point format, most significant Word).</u>	40079	R
Rx_FLOAT_LSW	<u>Resistance in Ohm if PT100 (Floating point format, least significant Word).</u>	40080	R
TEMP_RTD_FL_MSW	<u>Temperature read from PT100 in °C (Floating point format , most significant word).</u>	40081	R
TEMP_RTD_FL_LSW	<u>Temperature read from PT100 in °C (Floating point format , least significant word).</u>	40082	R
Rx_short	<u>Measured resistance if PT100 (in $\Omega/100$)</u>	40083	R
mVOLT_FL_MSW	<u>Measurement in mV in case of voltage input (Floating point format, most significant word).</u>	40084	R
mVOLT_FL_LSW	<u>Measurement in mV in case of voltage input (Floating point format, least significant word).</u>	40085	R
μ AMPER_FL_MSW	<u>Measurement in μA in case of current input (Floating point format, most significant word).</u>	40086	R
μ AMPER_FL_LSW	<u>Measurement in μA in case of current input (Floating point format, least significant word).</u>	40087	R

Disposal of Electrical & Electronic Equipment (Applicable throughout the European Union and other European countries with separate collection programs)



This symbol, found on your product or on its packaging, indicates that this product should not be treated as household waste when you wish to dispose of it. Instead, it should be handed over to an applicable collection point for the recycling of electrical and electronic equipment. By ensuring this product is disposed of correctly, you will help prevent potential negative consequences to the environment and human health, which could otherwise be caused by inappropriate disposal of this product. The recycling of materials will help to conserve natural resources. For more detailed information about the recycling of this product, please contact your local city office, waste disposal service or the retail store where you purchased this product.

This document is property of SENECA srl. Duplication and reproduction are forbidden, if not authorized. Contents of the present documentation refers to products and technologies described in it. All technical data contained in the document may be modified without prior notice Content of this documentation is subject to periodical revision.

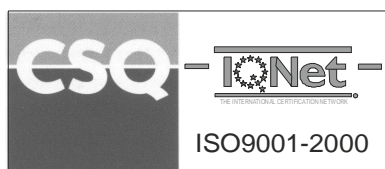

SENECA s.r.l.

Via Austria, 26 - 35127 - PADOVA - ITALY
Tel. +39.049.8705355 - 8705359 - Fax +39.049.8706287
e-mail: info@seneca.it - www.seneca.it

11 SETTABLE VALUES FOR MULTIPLE CHOICE PARAMETERS

The various options for the multiple choice parameters are listed below. Default values are indicated with the * symbol.

11.1 I.P.T. (ELECTRICAL INPUT)

TYPE

Selects the input type among the following:

1 = Voltage	5 = TC K	9 = TC B	13 = PT100 (3 wires)
2* = Current	6 = TCR	10 = TCE	14 = PT100 (4 wires)
3 = Potentiometer	7 = TCS	11 = TC N	
4 = TC J	8 = TCT	12 = PT100 (2 wires)	

11.2 S.C.A.L. (SETTING DISPLAYED VALUE)

FAHR

Selects if the temperature will be displayed in:

- 0* = Celsius degrees
- 1 = Fahrenheit degrees.

FILT

Sets the level filter. Admitted Value:

- 0* = no filter
- 1 ... 20.

11.3 A.L.1. / A.L.2. / A.L.3. / A.L.4. (ALARM SETTING)

TYPE 1 / TYPE2 / TYPE3 / TYPE4

Sets the alarm type :

- 0* = Inactive Alarm
- 1 = Alarm on the minimum threshold
- 2 = Alarm on the maximum threshold
- 3 = Retained alarm on the minimum threshold (reset is not automatic)
- 4 = Retained alarm on the maximum threshold (reset is not automatic).

rLY1/rLY2/rLY3/rLY4

Sets the functioning of the correspondent relay

0* = relay normally opened

1 = relay normally closed.

11.4 O.U.t. . (RETRANSMITTED OUTPUT SETTING)*tYPE*

Sets the type of the retransmitted output:

1 = 0..10V output 2* = 4..20 mA output

3 = 0..20 mA output

11.5 b.U.S. . (RS485 SETTINGS)*Addr*

Selects the slave Modbus address. Values from da 1 to 255. Default: 1.

PAR

Selects the parity control of the serial communication:

0* = None 1 = Even 2 = Odd.

dEL

Sets the response delay time. Values: 0 ..255. 0* = no delay, 1 = 1 pause, etc.

bAUD

Sets the Baudrate :

0 = 4800 3* = 38400 6 = 1200

1 = 9600 4 = 57600 7 = 2400

2 = 19200 5 = 115200 8 = 14400

11.6 S.Y.S. . (SYSTEM)*Cont*

Sets the display contrast:

Values from 1 (minimum contrast) to 20 (maximum contrast). Default: 10.

bURN

Behavior in case of Burn Out of PT100 or Thermocouple:

0* = Full scale indication

1 = Start scale indication.

11.7 d.F.L.t. (DEFAULT SETTING)

1 = Sets the default values for all the parameters.

8. SETTING EXAMPLES

8.1 Modification parameters examples

We are going to illustrate an example of $H_i - d$ parameter modification for a 6 digits model. In this example the digit to modify, that in the real case flashes, is bordered:

Once the parameter to modify has been selected, the set value is for example:

0 9 0 0

The pressure of the **DOWN** button entails:

0 9 0 9

DOWN has brought the digit to the maximum value.

Now the pressure of **OK/MENU** buttons entails the position shift of the digit to modify:

0 9 0 9

The pressure of the **UP** button entails:

0 9 1 9

that is the digit has been increased of a unit.

To set a negative value, place on the most significant digit by subsequent pressures of **OK/MENU** button :

0 9 1 9

By pressing the **DOWN** button:

-1 9 1 9

The last digit is brought to the most negative value: -1.

A further pressure of the **OK/MENU** button, entails the return to the voice correspondent to the just modified parameter:

H I - d

PARAMETERS MODIFICATION

The modification is performed digit by digit. The digit to modify **flashes**: on the figure this digit is bordered.

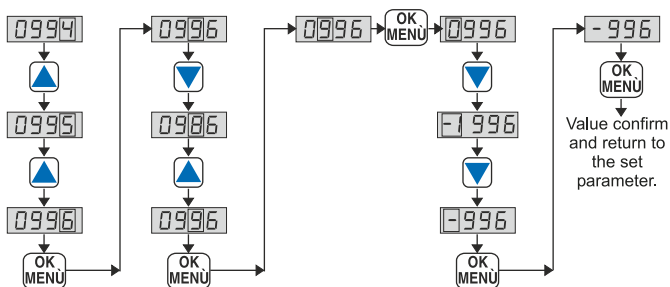

: Increments the digit value of a unit. : Decreases the digit value of a unit.

OK/MENU : Confirms the value of the digit and go to the next one.

OK/MENU : If last digit: confirms the value of the digit and an other pressure carries back to the just set parameter.

Notes on Values Setting

Negative Values: the last digit allows to insert also the '-' sign or "-1" value.

The Inserted Values are out of the parameter range: the value is carried within the range.

PROGRAMMING MENU SCHEME

ACCESS TO THE PROGRAMMING MENU :
 : Press the two buttons simultaneously for some seconds.

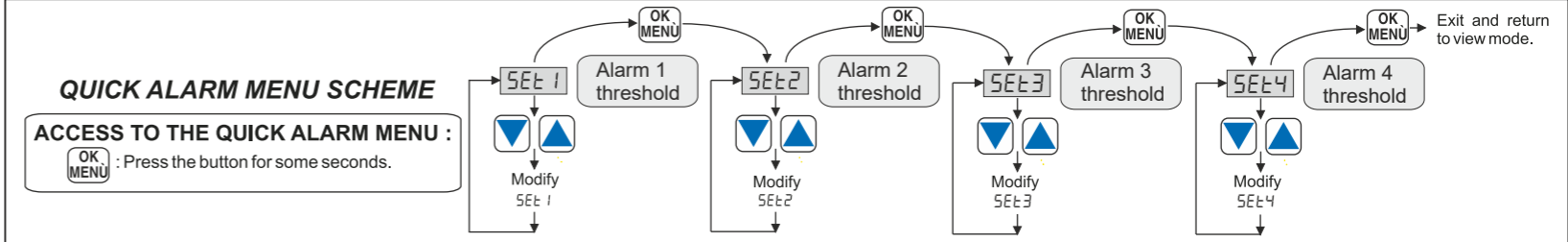
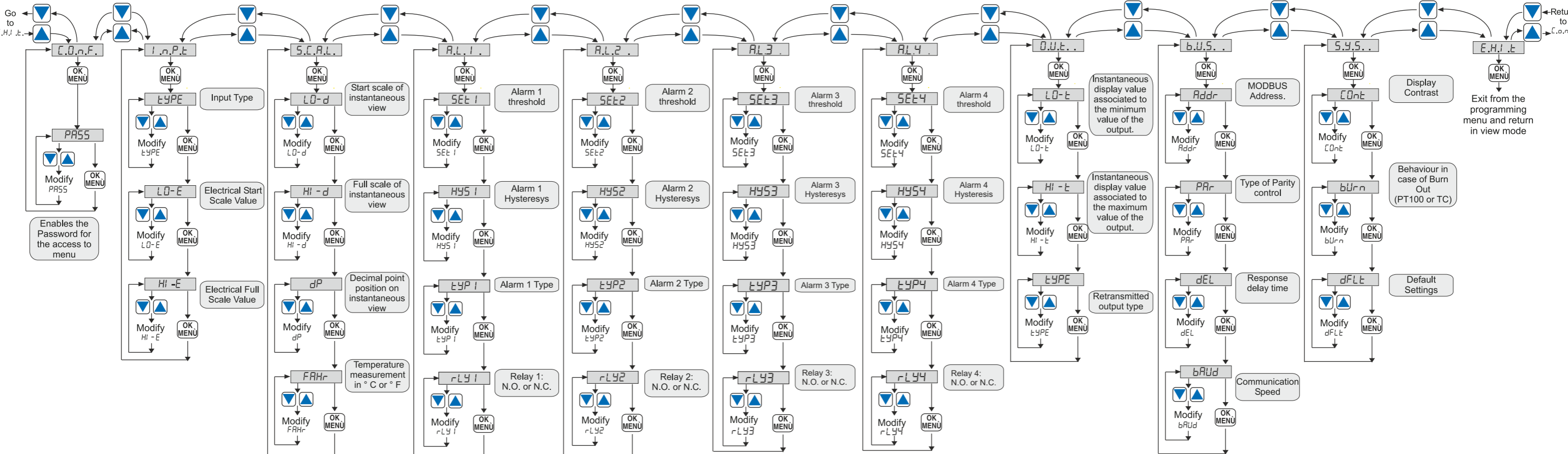



SCATTERGOOD & JOHNSON LTD

ELECTRICAL ENGINEERING & FLUID CONTROL DISTRIBUTORS

Est.1899

At Scattergood & Johnson Ltd, we pride ourselves on being a technical distributor to specialist industries.

Working with a range of quality product suppliers across a number of specialist markets, we are not your average 'box shifter' - we are your technical and supply chain partner.

We fully support every product we sell - for free! Our internal team and external sales engineers can answer any product or application question, no matter the complexity.

Backing up this technical ability is a range of 50,000+ products available from stock for nationwide next day delivery (same day if required!), or you can collect what you need from any of our trade counters around the UK.

Select your specialist interest below to learn more about how we can help.

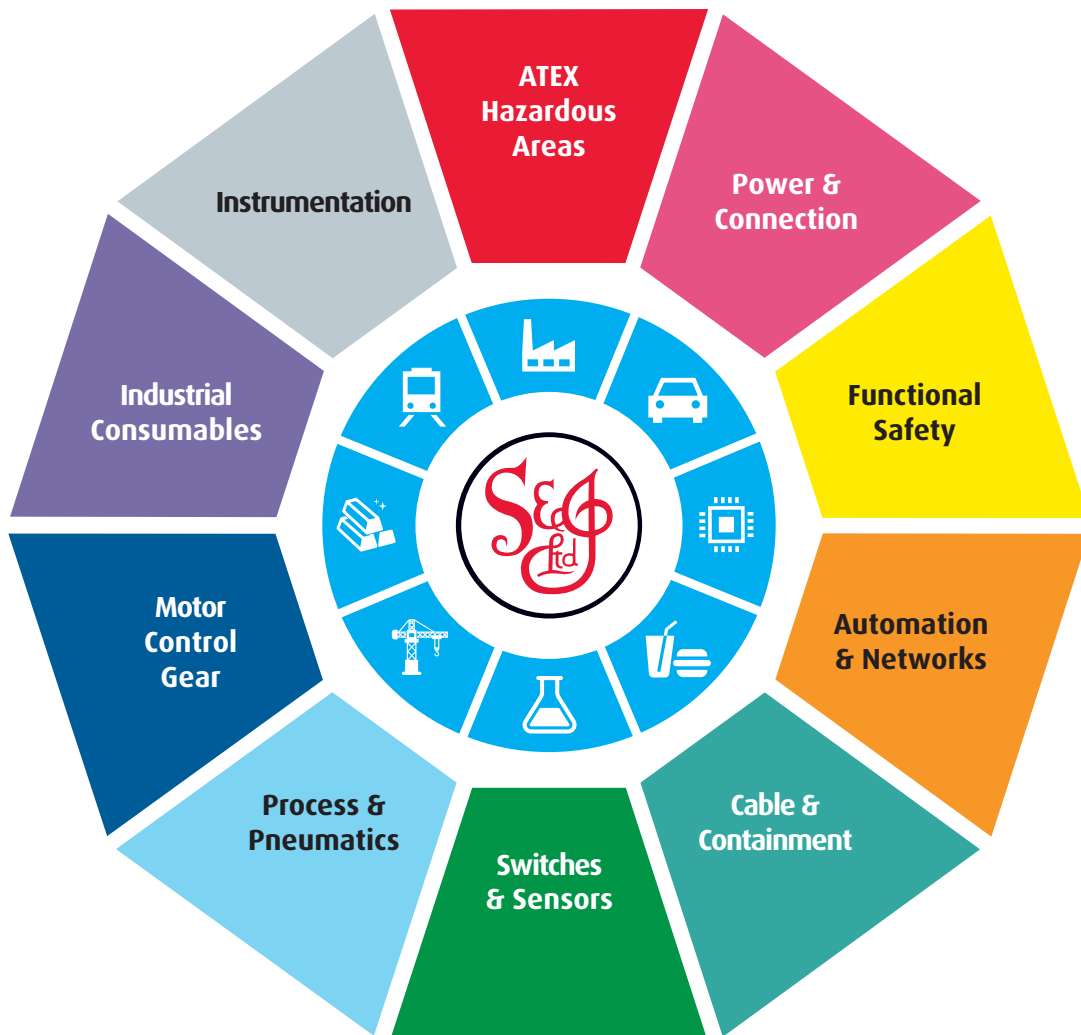

Online, In Branch and On the Road - Scattergood & Johnson Ltd, there when you need us.

www.scatts.co.uk