

Best Selection

Fiber Sensors

Best Selection Catalog

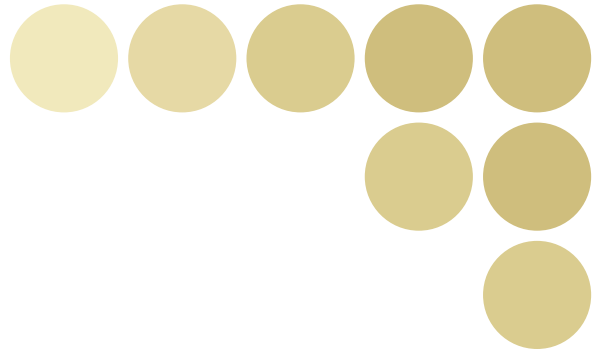

OMRON's Fiber Sensors continue to support an increasing range of applications.

This catalog brings you the latest information on our Fiber Units.



E32-series Fiber Units

Amplifier Units

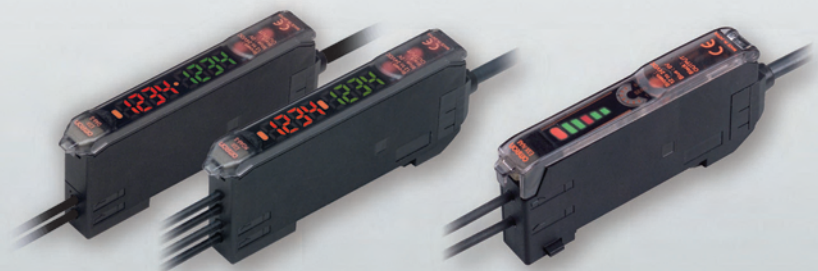

E3X-DA-S/-MDA Series

E3X-NA Series

realizing

Fiber Unit

Standard Models

First, Our Standard Lineup

These Fibers Units can be used in a variety of applications, such as detecting the presence of workpieces and positioning.

A Wide Variety of Shapes for Adapting to Different Installation Locations

Choose the model that suits the installation space from a wide variety of shapes and sizes (7 shapes, in standard or small sizes).



Space Savings and Simple Mounting

Flat Models

Flat models that allow simple screw mounting and straightforward wiring have been added to the lineup. Using these models eliminates the problem of fibers getting caught on surrounding objects.



Flat model

Detect Workpieces in Tight Spaces

Custom-produced Sleeves

Models with sleeves allow detection in tight spaces. We will perform the time-consuming task of fashioning the sleeve, with a length and bends to suit the space (except for ultrafine sleeves).

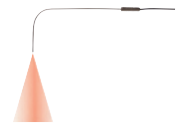

Models with sleeves

Flexible, Pliable Fiber That Can Be Handled Like Wire

We have developed a broad range of fibers to meet a wide variety of needs. Multicore (flexible) fiber is a new type of standard fiber that can be used like wire without worrying about the bending radius. We have also produced fiber that will not break when used in moving parts and fiber that is not degraded by contact with oil.



Conventional fiber

Flexible fiber

You will certainly appreciate the ease of use that flexible fiber ensures.

Length Can Be Specified in 1-m Units

Saving Energy and Work

We will produce fiber of the required length (in meter units). For large-scale installations, specifications of up to 20 m can be handled. (Specifications of 0.3 m and 0.5 m are also possible.)



Special-beam Models

Detection with Increased Reliability

...▶ P10

A variety of heads incorporating the latest optical technology makes it possible to solve common problems related to detection and to increase reliability.

- Resistant to dust and dirt
 - Capable of detecting small workpieces
 - Resistant to workpiece vibration
- Use these models to handle unstable detection conditions.

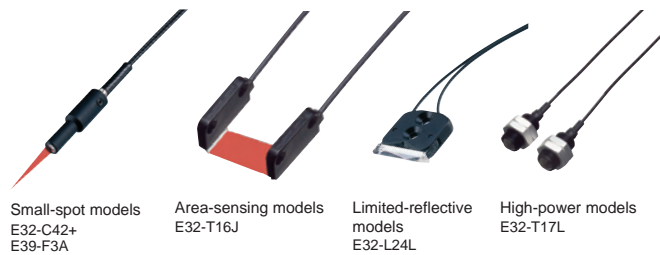

Environment-resistant Models

High Resistance to External Conditions with Fiber

...▶ P14

We have developed model variations for adapting to a variety of environmental conditions. These models enable detection in high-temperature environments and vacuums.

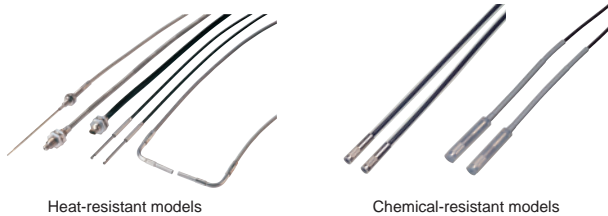

- High-temperature environments
 - Environments subject to the splattering of chemicals
 - Vacuums
- Use these models to handle applications in special environments.

Application-specific Models

Fiber Units for the Food-packaging, Semiconductor, and FPD Industries

...▶ P16

These models, which were developed for specific applications, offer top-quality detection performance.

- Label detection
 - Liquid-level detection
 - Alignment and mapping of glass substrates
 - Wafer mapping
- Use these models for specific applications.



Selection Guide



Fiber Units

Detection conditions	Environmental conditions	Standard environments	Special environments
		Standard Models ●●●▶ P.6	Environment-resistive Models ●●●▶ P.14
Standard detection <ul style="list-style-type: none"> Workpiece presence Positioning Level differences and marks 			
Special-beam <ul style="list-style-type: none"> Long-distance sensing, resistance to dust and dirt Small beam, resistance to rattling Detection of transparent objects 		Special-beam Models ●●●▶ P.10	
Application-specific <ul style="list-style-type: none"> Labels Liquid level Alignment and mapping of glass substrates Wafer mapping 		Application-specific Models ●●●▶ P.16	

Amplifier Units

Type	Digital		Manual
Appearance		2-channel models	
Response time	48 μs, 1 ms, or 4 ms (2-output models: 80 μs, 1 ms, or 4 ms)	100 μs, 1 ms, or 4 ms	200 μs (high-speed models: 20 μs)
Light source	Red, green, blue, or infrared LED		Red or green LED
Function	Dual display (including digital, bar, percent, and hold display functions) Threshold adjustment performed manually or by teaching OFF-delay, ON-delay, one-shot timer (adjustable from 1 ms to 5 s)		LED bar display (5 levels) 8-turn sensitivity adjuster OFF delay timer (fixed at 40 ms)
	Advanced-function models are available (2-output/input models).		Water-resistant models are available.
Models	E3X-DA□-S E3X-DA□TW-S (2-output model) E3X-DA□RM-S (input model)	E3X-MDA□	E3X-NA□ E3X-NA□F (high-speed model) E3X-NA□V (water-resistant model)

CONTENTS

■ Selection Guide		P4
<hr/>		
■ Overview of Features, Applications, and Variations		
<hr/>		
Standard Models	Flexible (New Standard)	P6
	Standard	P6
	Break-resistant	P6
	Fluorine Coating	P7
<hr/>		
Special-beam Models	Long Distance, High Power	P10
	Ultracompact, Ultrafine Sleeve	P10
	Coaxial, Small Spot	P11
	Fine Beam (Narrow Vision Field)	P12
	Area Sensing	P12
	Retroreflective	P13
	Limited-reflective	P13
<hr/>		
Environment-resistive Models	Heat-resistant	P14
	Chemical-resistant	P14
	Vacuum-resistant	P15
<hr/>		
Application-specific Models	Label Detection	P16
	Liquid-level Detection	P16
	Glass-substrate Alignment	P17
	Glass-substrate Mapping	P17
	Water Mapping	P18
<hr/>		
■ Ordering Information		
	Through-beam Fiber Units	P19
	Fiber Units with Reflective Sensors	P25
	Application-specific Fiber Units	P30
<hr/>		
■ Ratings/Characteristics		P34
<hr/>		
■ Dimensions		
	Through-beam Fiber Units	P36
	Fiber Units with Reflective Sensors	P42
	Application-specific Fiber Units	P47
<hr/>		
■ Precautions		P51

Features/Applications

Standard Models

Flexible (New Standard)

R

- Perform wiring without worrying about the bending radius.
- Choose the model to suit the installation space from a variety of shapes.

Flexible fiber

Conventional fiber

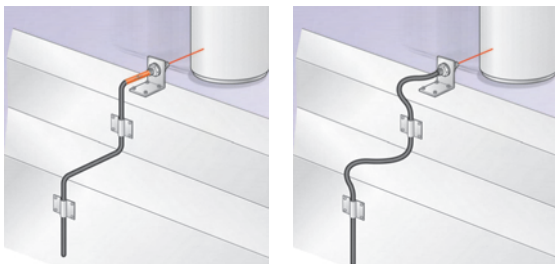

Fewer problems

Light intensity affected by bends in fiber
Fiber broken by getting caught on surrounding objects

Feature: Multicore (Flexible) Fibers



A large number of ultrafine cores are all surrounded by cladding. As a result, the fiber is flexible and can be bent without significantly reducing the light intensity. This helps solve problems, such as fiber being broken by getting caught on other objects.

Ratings/Characteristics

Min. sensing object	0.005-mm dia.
Min. bending radius	1 mm
Ambient temperature	-40°C to 70°C (no icing or condensation)
Fiber material	Plastic (Free-cut)

Standard

- Choose the model to suit the installation space from a variety of shapes.
- New flat models allow space savings and simple installation.



Screw-shaped

Cylindrical

Flat

Equipped with sleeve

Feature: Flat Models

Flat models, which allow simple attachment and wiring, have been added to the lineup. Choose the model to suit the installation space from 3 sensing directions and 2 sizes, standard and small.



Ratings/Characteristics

Min. sensing object	0.005-mm dia.
Min. bending radius	10 or 25 mm*
Ambient temperature	-40°C to 70°C (no icing or condensation)
Fiber material	Plastic (Free-cut)

*Depends on the fiber diameter.

Break-resistant

B

- Bundle-fiber models can be used for moving parts.
- Capable of withstanding at least one million repeated bends (in typical applications).



Feature: Bundle Fibers

The Fiber Units contain a large number of independent fine fibers, ensuring a high degree of flexibility.



Ratings/Characteristics

Min. sensing object	0.005-mm dia.
Min. bending radius	4 mm (withstands repeated bending)
Ambient temperature	-40°C to 70°C (no icing or condensation)
Fiber material	Plastic (Free-cut)

Standard Models

Fluorine Coating



- Fiber degradation due to oil is prevented using a fluoro-resin coating.
- Free cutting is possible with cutter provided.

Oil is blocked!

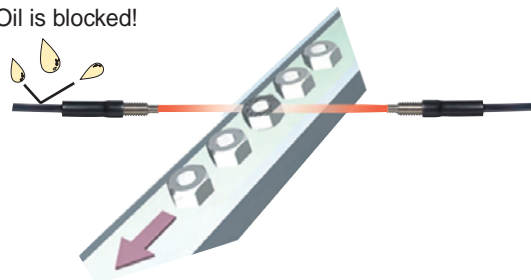

Feature: Fluorine Coating

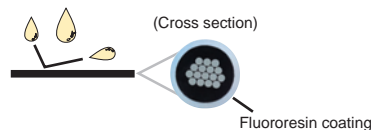

Fluoro-resin is used as the sheath material to prevent fiber degradation resulting from oil adhesion.

Note: The tip of the head is not chemical-resistant.

Ratings/Characteristics

Min. sensing object	0.005-mm dia.
Min. bending radius	4 mm
Ambient temperature	-40°C to 70°C (with no icing or condensation)
Fiber material	Plastic Free-cut

Fiber Customization Service (Fiber Length, Sleeve Length, and Bends)

Fiber Length



- Applicable Models
Standard models

- Model Number Used for Ordering
Standard model number + Fiber length
Fiber length: 0.3 m, 0.5 m, or any length from 1 to 20 m (in 1-m units)

This customization/delivery service applies to standard models. It is aimed at reducing industrial waste and simplifying the installation procedure.

Fiber Length vs. Sensing Distance

Through-beam Fiber Units

(Fiber length of 2 m corresponds to 100%.)

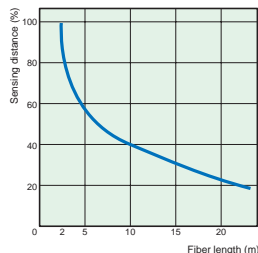

Fiber Units with Reflective Sensors

(Fiber length of 2 m corresponds to 100%.)

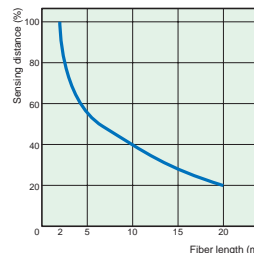

Sleeve Length and Bends

- Applicable Models
E32-TC200B/E32-TC200F
E32-DC200B/E32-DC200F
The E32-DC200B cannot be bent.

Model Number Used When Changing Only the Sleeve Length



Model: E32-[*1]C200[*2]-S[*3]

Model Number Used When Changing the Sleeve Length and Bends

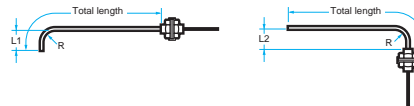

Model Numbers Incorporating the Bending Radius, R, and Dimensions L1 and L2

Bending radius	Specifying L1 Only (Units: mm)		Specifying L2 Only (Units: mm)	
	L1 (±1)	Model number	L2 (±1)	Model number
R5	10	E32-[*1]C200[*2]-S[*3]A1	5	E32-[*1]C200[*2]-S[*3]A3
	15	E32-[*1]C200[*2]-S[*3]A2	10	E32-[*1]C200[*2]-S[*3]A4
R7.5	12.5	E32-[*1]C200[*2]-S[*3]B1	7.5	E32-[*1]C200[*2]-S[*3]B3
	17.5	E32-[*1]C200[*2]-S[*3]B2	17.5	E32-[*1]C200[*2]-S[*3]B4
R10	15	E32-[*1]C200[*2]-S[*3]C1	10	E32-[*1]C200[*2]-S[*3]C3
	20	E32-[*1]C200[*2]-S[*3]C2	20	E32-[*1]C200[*2]-S[*3]C4
R12.5	17.5	E32-[*1]C200[*2]-S[*3]D1	12.5	E32-[*1]C200[*2]-S[*3]D3
	22.5	E32-[*1]C200[*2]-S[*3]D2	22.5	E32-[*1]C200[*2]-S[*3]D4

*1: Insert "T" for Through-beam Fiber Units and "D" for Fiber Units with Reflective Sensors.
*2: Insert the "B" or "F" that appears at the end of the original model number.
*3: Insert "50" if the total length is 50 mm. The total length must not exceed 120 mm.

















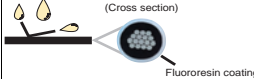
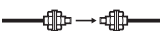







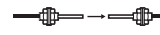



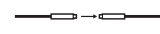





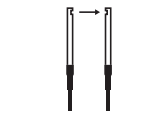



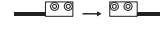

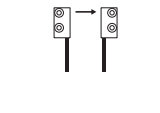

Features/Applications

Standard Models

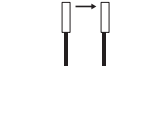

Overview of Model Variations

Through-beam Fiber Units

Sensing distance (mm) (See note 1.)
Model

Type (See note 2.)		Flexible (New Standard)  Flexible and pliable 	Standard 	Break-resistant  Withstands repeated bending 	Fluorine coating  (Cross section) Fluororesin coating Cable protected against oil 
Screw-shaped (top-view) 	M4	 530	 760	 680	 680
		E32-T11R	E32-TC200	E32-T11	E32-T11U
	M3	 130	 220	 200	
		E32-T21R	E32-TC200E	E32-T21	
(with sleeve) 	M4 (1.2-dia. sleeve)	 530	 760		
		E32-TC200BR	E32-TC200B		
	M3 (0.9-dia. sleeve)	 130	 220		
		E32-TC200FR	E32-TC200F		
Cylindrical (top-view) 	3 dia.	 530	 760	 680	
		E32-T12R	E32-T12	E32-T12B	
	1.5 dia.	 130	 220	 200	
		E32-T22R	E32-T222	E32-T22B	
(side-view) 	3 dia.	 210	 460		
		E32-T14LR	E32-T14L		
	1 dia.	 50	 130		
		E32-T24R	E32-T24		
Flat (top-view) 	15 × 8 × 3	 530	 760	 680	
		E32-T15XR	E32-T15X	E32-T15XB	
	12 × 7 × 2	 130	 220	 150	
		E32-T25XR	E32-T25X	E32-T25XB	
(side-view) 	15 × 8 × 3	 210	 460		
		E32-T15YR	E32-T15Y		
	12 × 7 × 2	 50	 130		
		E32-T25YR	E32-T25Y		
(flat-view) 	15 × 8 × 3	 210	 460		
		E32-T15ZR	E32-T15Z		
	12 × 7 × 2	 50	 130		
		E32-T25ZR	E32-T25Z		

Note 1. The sensing distances apply for use in combination with the E3X-DA-S Amplifier Unit (general-purpose, standard mode).













2. These symbols are defined as follows.  : Flexible fiber,  : Bendable fiber,  : Fluorine-coated fiber.

Standard Models

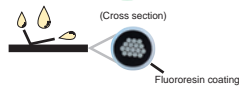

Overview of Model Variations

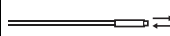
Sensing distance (mm) (See note 1)
Model

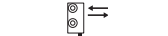
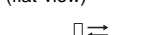
Fiber Units with Reflective Sensors

Type (See note 2.)		Flexible (New Standard)   Flexible and pliable	Standard 	Break-resistant   Withstands repeated bending	Fluorine coating  (Cross section)  Cable protected against oil
Screw-shaped (top-view) 	M6	170	300	170	170
		E32-D11R	E32-DC200	E32-D11	E32-D11U
	M3	30	80	30	
		E32-D21R	E32-DC200E	E32-D21	
(with sleeve) 	M6 (2.5-dia. sleeve)	170	300		
		E32-DC200BR	E32-DC200B		
	M3 (1.2-dia. sleeve)	30	80		
		E32-DC200FR	E32-DC200F		
Cylindrical (top-view) 	3 dia.	170	230	70	
		E32-D12R	E32-D12	E32-D221B	
	3 dia. (1.5 dia.)	30	80	30	
		E32-D22R	E32-D22	E32-D22B	
(side-view) 	6 dia.	45	110		
		E32-D14LR	E32-D14L		
	2 dia.	15	30		
		E32-D24R	E32-D24		
Flat (top-view) 	15 × 10 × 3	170	300	170	
		E32-D15XR	E32-D15X	E32-D15XB	
	12 × 7 × 2	30	80	50	
		E32-D25X	E32-D25X	E32-D25XB	
(side-view) 	15 × 10 × 3	40	100		
		E32-D15YR	E32-D15Y		
	12 × 8 × 2	8	20		
		E32-D25YR	E32-D25Y		
(flat-view) 	15 × 10 × 3	40	100		
		E32-D15ZR	E32-D15Z		
	12 × 8 × 2	8	20		
		E32-D25ZR	E32-D25Z		

Note 1. The sensing distances apply for use in combination with the E3X-DA-S Amplifier Unit (general-purpose, standard mode).

2. These symbols are defined as follows.  : Flexible fiber,  : Bendable fiber,  : Fluorine-coated fiber.

Features/Applications

Special-beam Models

Long Distance, High Power

- Powerful beam reduces influence of dust and dirt.
- Long sensing distance enables use in large-scale installations.



Applications

Detecting parts inside (translucent) containers

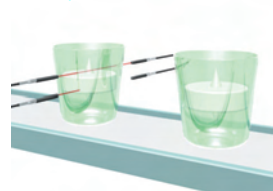

Detecting workpieces in coating processes



Ratings/Characteristics

Ambient temperature	-40°C to 70°C (no icing or condensation)
Fiber material	Plastic Free-cut

Overview of Model Variations

Type	Features	Shape, sensing distance (mm)*	Model number
Through-beam	Equipped with large lens	20,000	E32-T17L
	Side-view, screw mounting	3,400	E32-T14
	M4 screw	1,330	E32-T11L
Reflective	Equipped with large lens	700	E32-D16
	M6 screw	400	E32-D11L

Ultracompact, Ultrafine Sleeve

- Ultracompact head can be installed in tight spaces.
- Ultrafine sleeve ensures reliable detection of small objects, such as electronic components.



Applications

Alignment inspections

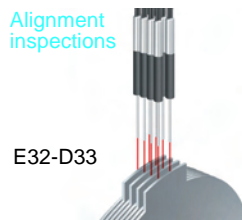

Detection of terminals



Ratings/Characteristics

Min. sensing object	0.005-mm dia.
Ambient temperature	-40°C to 70°C (no icing or condensation)
Material	Plastic

Overview of Model Variations

Type	Features	Shape, sensing distance (mm)*	Model number
Through-beam	1-dia. cylinder	130	E32-T223R
	0.5-dia. sleeve (0.25-dia. opening)	44	E32-T33-S5
	0.22-dia. sleeve (0.1-dia. opening)	5	E32-T334-S5
Reflective	0.8-dia. sleeve	16	E32-D33
	0.5-dia. sleeve	3	E32-D331

*The sensing distances apply for use in combination with the E3X-DA-S Amplifier Unit (general-purpose, standard mode).

Special-beam Models

Coaxial, Small Spot

- Small spot diameter (0.1 mm min. in diameter) enables the reliable detection of small workpieces.
- Use of red light ensures easy visual recognition and simple positioning.

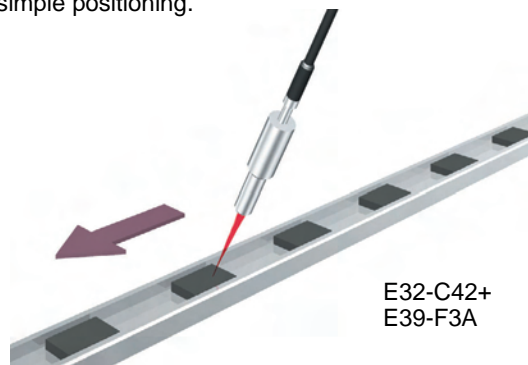

Applications

Detecting of CDs

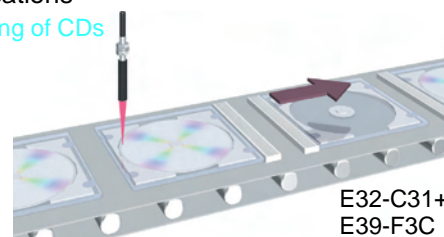

Ratings/Characteristics

Min. sensing object	0.005-mm dia.
Ambient temperature	-40°C to 70°C (no icing or condensation)
Fiber material	Plastic

Overview of Model Variations

Type	Features	Shape, sensing distance (mm)*	Model number
Coaxial, reflective	Coaxial, M6 screw	300	E32-CC200
	Coaxial, 3-dia. cylinder	150	E32-D32L
	Small spot	0.1-dia. spot at a distance of 7 mm	E32-C41+ E39-F3A-5
	Small variable spot	Spot diameter variable in the range 0.1 to 0.6 mm at distances in the range 6 to 15 mm	E32-C42+ E39-F3A
	Long distance, small spot	0.5-dia. spot at 17 mm	E32-C31+ E39-F3B
	Long distance, parallel light	Spot diameter of 4 mm max. at distances in the range 0 to 20 mm	E32-C31+ E39-F3C

*The sensing distances apply for use in combination with the E3X-DA-S Amplifier Unit (general-purpose, standard mode).

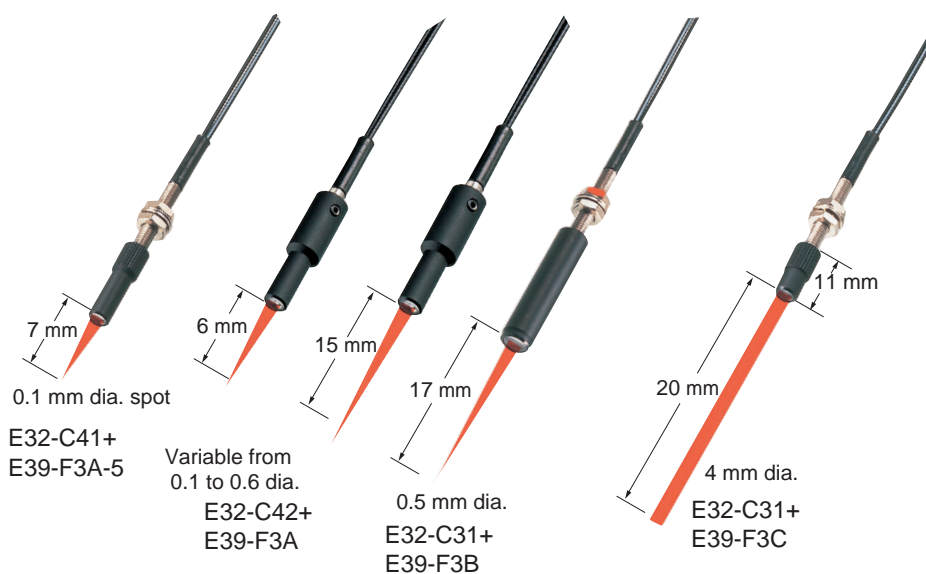

Features/Applications

Special-beam Models

Fine Beam (Narrow Vision Field)

- Fine beam reduces unwanted light in surrounding area.
- Powerful beam allows use in applications requiring a long sensing distance.

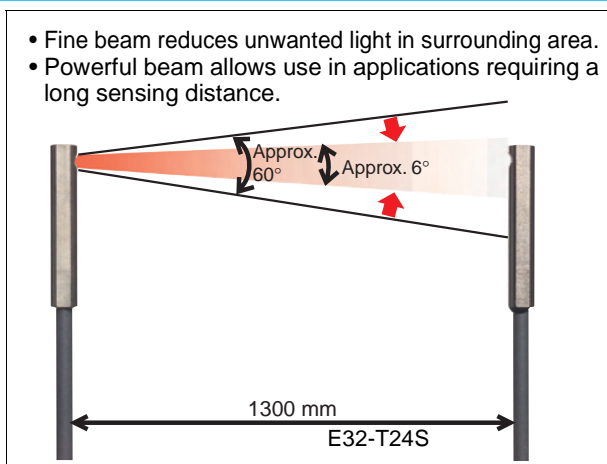

Applications

Alignment inspection
of orientation flats

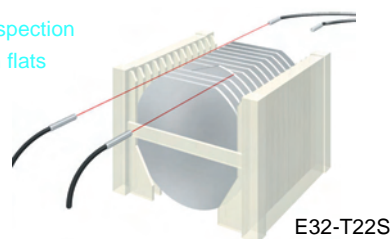

Ratings/Characteristics

Min. bending radius	10 mm
Ambient temperature	-40°C to 70°C (no icing or condensation)
Fiber material	Plastic (Free-cut)

Overview of Model Variations

Type	Features	Shape, sensing distance (mm)*	Model number
Through-beam	Top view	1,900	E32-T22S
	Side view	1,300	E32-T24S

Area Sensing

- These Fiber Units ensure greater reliability with the detection of position inconsistencies in passing workpieces and the presence of workpieces with holes.
- Wide sensing bands of 11 and 30 mm (through-beam models) enable the detection of large position inconsistencies.

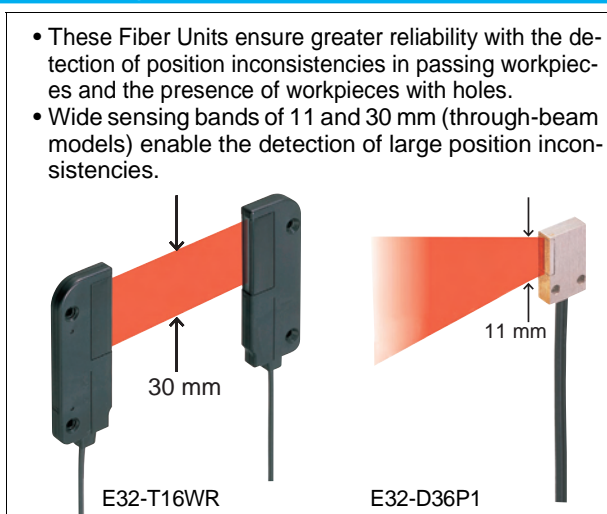

Applications

Detecting passage of
candies



E32-T16WR

Detecting chips on film

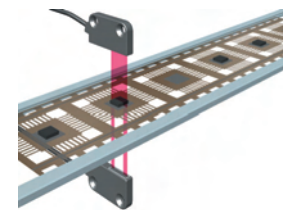

E32-T16PR

Ratings/Characteristics

Ambient temperature	-40°C to 70°C (no icing or condensation) E32-T16W□ only: -25°C to 55°C
Fiber material	Plastic (Free-cut)

Overview of Model Variations

Type	Features	Shape, sensing distance (mm)*	Model number
Through-beam	Sensing width: 11 mm	840	E32-T16PR
	Sensing width: 11 mm Flat-view	750	E32-T16JR
	Sensing width: 30 mm	1,300	E32-T16WR
Refractive	Beam width: 11 mm	150	E32-D36P1

*The sensing distances apply for use in combination with the E3X-DA-S Amplifier Unit (general-purpose, standard mode).

Special-beam Models

Retroreflective

- The return optical path ensures that more light is interrupted by transparent workpieces than with through-beam models.
- Equipped with MSR function to eliminate light reflect-

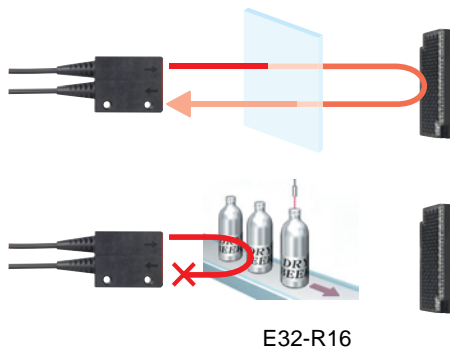

E32-R16

Applications

Detecting translucent medicine

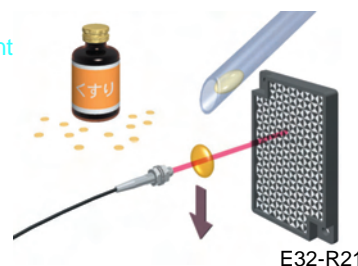

E32-R21

Ratings/Characteristics

Ambient temperature	E32-R21: -40°C to 70°C E32-R16: -25°C to 55°C (with no icing or condensation)
Fiber material	Plastic Free-cut

Overview of Model Variations

Type	Features	Shape, sensing distance (mm)*	Model number
Retro-reflective	MSR function, M6 screw	250	E32-R21
	MSR function, screw mounting, long distance	1,500	E32-R16

Limited-reflective

- Limited-reflective models eliminate light reflected from distant objects.
- Small level differences can be reliably detected.
- The optical-axis direction can be selected according to the installation space.



E32-L24L

Applications

Detecting connector pins

Detecting wafers (glass substrates)



E32-L25L

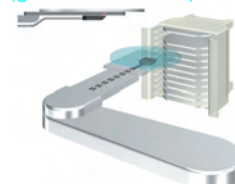

E32-L24L

Ratings/Characteristics

Min. sensing object	0.005-mm dia.
Fiber material	Plastic Free-cut 200°C models only: Glass

Overview of Model Variations

Type	Features	Shape, sensing distance (mm)*	Model number
Limited-reflective	Ultracompact, flat-view Ideal for checking stocks of glass substrates	0 to 4	E32-L24S
	Heat-resistant up to 105°C, top-view	5.4 to 9 (center: 7.2)	E32-L25L
	Wide sensing range, flat-view	0 to 15	E32-L16
	Heat-resistant up to 200°C, flat-view	4 to 10	E32-L86

*The sensing distances apply for use in combination with the E3X-DA-S Amplifier Unit (general-purpose, standard mode).

Features/Applications

Environment-resistive Models

Heat-resistant

- These Fiber Units can be used for various applications in temperatures up to 400°C.

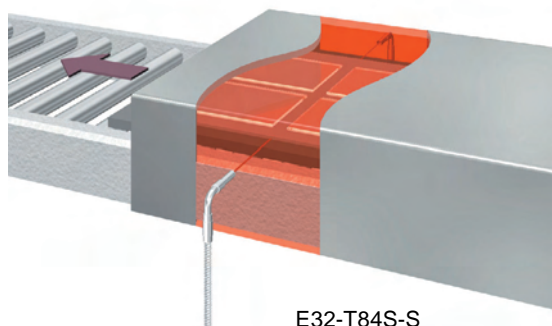

Applications

Detecting wafers in high-temperature environments

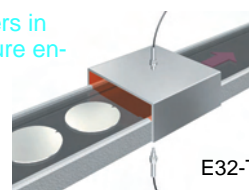

Ratings/Characteristics

	150°C models	200°C and higher models	
		E32-T81R E32-D81R	All other models
Min. bending radius	35 mm	10 mm	25 mm
Fiber material	Plastic (fluororesin coating) <small>Free-cut</small>	Glass (fluororesin coating)	Glass (SUS spiral coating)

Overview of Model Variations

Type	Ambient temperature	Features	Shape, sensing distance (mm)*	Model number
Through-beam	-40°C to 150°C	M4 screw	760	E32-T51
	-40°C to 200°C	L-shaped, long distance	1,300	E32-T84S-S
	-60°C to 350°C	M4 screw	450	E32-T61-S
Refractive	-60°C to 350°C	M6 screw	90	E32-D61-S
	-40°C to 400°C	M6 screw, with sleeve	60	E32-D73-S

Chemical-resistant

- Built-in lens and high-power beam reduce the influence of dirt and drops of water.
- Round design prevents drops of water sticking to the head (E32-T11F).

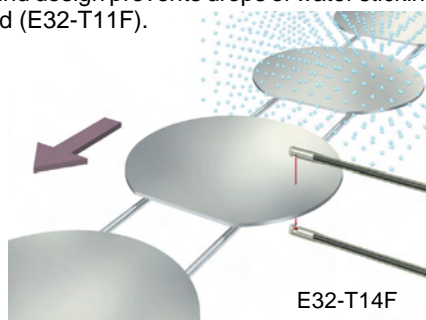

Applications

Detecting workpieces in cleaning processes

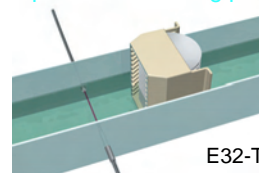

Ratings/Characteristics

	All other models	E32-T51F	E32-T81F-S
Ambient temperature	-40°C to 70°C	-40°C to 150°C	-40°C to 200°C
Fiber material	Plastic (fluororesin coating) <small>Free-cut</small>		Glass (fluororesin coating)

Overview of Model Variations

Type	Features	Shape, sensing distance (mm)*	Model number
Through-beam	Water-resistant round head	2,000	E32-T11F
	Built-in lens, high power	3,000	E32-T12F
	Heat-resistant up to 200°C	700	E32-T81F-S
Refractive	Built-in lens, high power	95	E32-D12F

*The sensing distances apply for use in combination with the E3X-DA-S Amplifier Unit (general-purpose, standard mode).

Environment-resistive Models

Vacuum-resistant

- These models can be used in high-vacuum environments at pressures from 10^{-5} to 0.1 Pa.
- The 4-channel multi-flange, which has a maximum leakage rate of 1×10^{-10} Pa·m³/s, contributes to space savings.



Applications (Configuration Example)

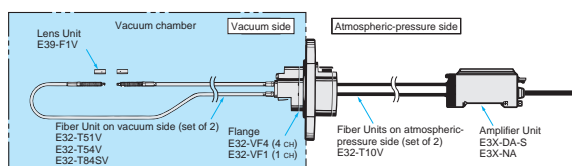

Ratings/Characteristics

	120°C models	200°C models	Atmospheric-pressure side
Min. bending radius	30 mm	25 mm	
Fiber material	Glass (fluorescein coating)	Glass (SUS spiral coating)	Plastic Free-cut

Overview of Model Variations

Type	Features	Shape, sensing distance (mm)*	Model number
Through-beam	M4 screw, top-view, heat-resistant up to 120°C, long distance	1,000	E32-T51V+ E39-F1V
	L-shaped, heat-resistant up to 120°C	130	E32-T54V 1M
	L-shaped, long distance, heat-resistant up to 200°C	480	E32-T84SV 1M

*The sensing distances apply for use in combination with the E3X-DA-S Amplifier Unit (general-purpose, standard mode).

Fiber Units on Atmospheric-pressure Side

Appearance	Type	Model number
	Common	E32-T10V 2M

Flanges

Appearance	Type	Model number
	4-channel flange	E32-VF4
	1-channel flange	E32-VF1

Ratings/Characteristics

Item	Number of channels	4 channels	1 channels
	Model number	E32-VF4	E32-VF1
Leakage rate	1×10^{-10} Pa·m ³ /s max.		
Ambient temperature	Operating: -25°C to 55°C Storage: -25°C to 55°C		
Material	Aluminum (A5056)		Stainless steel (SUS304) Aluminum (A5056)
Flange-seal material	Fluorocarbon rubber (Viton)		
Weight (packed state)	Approx. 280 g		Approx. 240 g

Features/Application

Application-specific Models

Label Detection

- Built-in lens and high-power beam enable the reliable detection of labels through a mounting board.
- These Fiber Units can be washed with hydrogen peroxide, making them ideal for the food industry.



Applications

Detecting labels

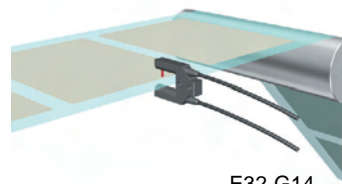

E32-G14

Ratings/Characteristics

Ambient temperature	-40°C to 70°C (no icing or condensation)
Fiber material	Plastic (Free-cut)
Degree of protection	IP67

Overview of Model Variations

Type	Features	Shape, sensing distance (mm)*	Model number
Through-beam	Slot sensor, no adjustment of optical axis required	10	E32-G14
	Screw mounting, side-view	3,400	E32-T14

Liquid-level Detection

- Area sensing is possible with minimal influence from bubbles and drops of water (E32-A01/A02/D36T).
- For safety when disconnections occur, two models have been developed, a light ON model for liquid presence and a light ON model for liquid absence (E32-A01/A02).

Tube-mounting model



E32-D36T

Liquid-contact model

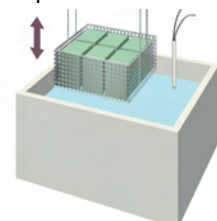

E32-D82F1

Operating Principle

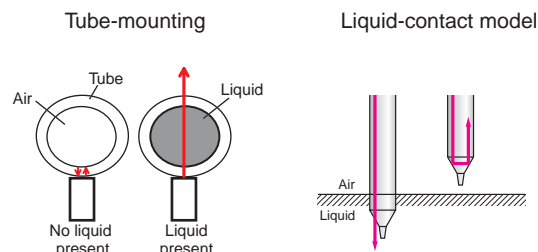

The presence/absence of liquid is detected using the refractive properties of light. More specifically, it utilizes the fact that the difference in refractive index between the air and the tip/tube is larger than the difference between the liquid and the tip/tube.

Overview of Model Variations

Type	Features	Shape, sensing distance (mm)*	Model number
Tube-mounting	Light ON when liquid is present (ideal for checking lower limits)	Applicable tube: Transparent tube with a diameter of 3.2, 6.4, or 9.5 mm and a recommended wall thickness of 1 mm	E32-A01
	Light ON when liquid is absent (ideal for checking for overflow)	Applicable tube: Transparent tube with a diameter in the range 6 to 13 mm and a recommended wall thickness of 1 mm	E32-A02
	No restriction on tube diameter, resistant to bubbles and drops of water	Applicable tube: Transparent tube (no restriction on diameter)	E32-D36T
Liquid-contact	Heat-resistant up to 200°C, shape prevents liquid buildup	Liquid-contact model	E32-D82F1

*The sensing distances apply for use in combination with the E3X-DA-S Amplifier Unit (general-purpose, standard mode).

Application-specific Models

Glass-substrate Alignment

- There is little variation of detection position within the detection range (± 0.1 mm max.)
- The different model variations can handle a variety of sensing distances and temperature conditions.



E32-L16

Engineering Data (E32-A07/A08/L16)

Detection-Position Characteristic (Typical Examples)

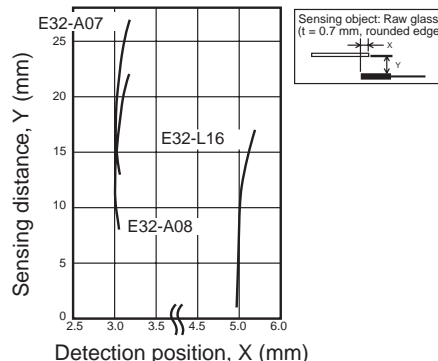

Overview of Model Variations

Type	Features	Shape, sensing distance (mm)*	Model number
Limited-reflective	0 to 15 mm, wide-range sensing	0 to 15	E32-L16
	Long-distance sensing	10 to 20	E32-A08
		15 to 25	E32-A07E1 E32-A07E2
	Heat-resistant up to 300°C	5 to 18	E32-L66

Glass-substrate Mapping

- These models can reliably detect thin glass-substrate end faces ($t = 0.5$ mm, beveled edge).
- Using a large-diameter lens makes it possible to cope with tilting of the glass substrates.

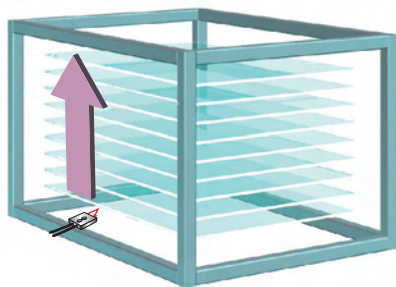

E32-A09

Engineering Data (E32-A09)

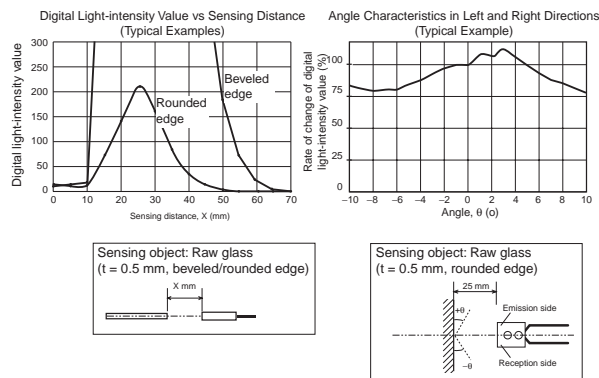

Overview of Model Variations

Type	Features	Shape, sensing distance (mm)*	Model number
Limited-reflective	Large-diameter lens ensures resistance to tilting	15 to 38 (center: 25)	E32-A09
	Heat-resistant up to 150°C		E32-A09H
	Heat-resistant up to 300°C	20 to 30 (center: 25)	E32-A09H2

*The sensing distances apply for use in combination with the E3X-DA-S Amplifier Unit (general-purpose, standard mode).

Features/Applications

Application-specific Models

Wafer Mapping

- Wafers are reliably detected with an ultrafine beam.
- The optical axis is adjusted before delivery to allow easy installation.

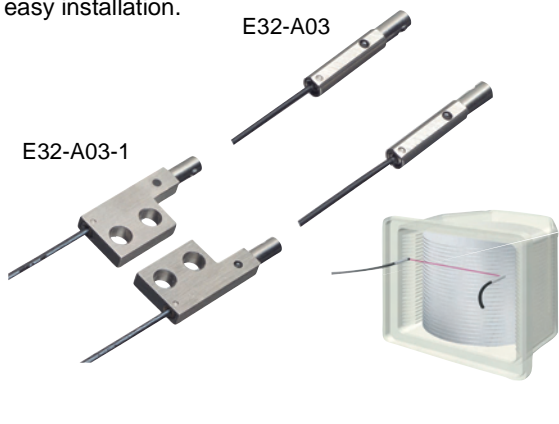

■ Features

Optical axis adjusted before delivery so that displacement is typically within 0.1°.

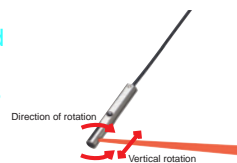

■ Engineering Data

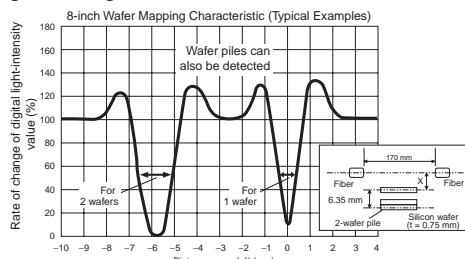

■ Overview of Model Variations

Type	Features	Shape, sensing distance (mm)*	Model number
Through-beam	Opening angle: 1.5°		E32-A03
	With mounting flange		E32-A03-1
	Opening angle: 3° ultraslim		E32-A04
	With mounting flange		E32-A04-1

*The sensing distances apply for use in combination with the E3X-DA-S Amplifier Unit (general-purpose, standard mode).

Responding to the Increasing Size of Installations

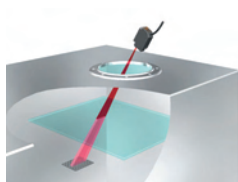

Glass detection through a view port

- ◆ Impressive long-distance sensing capacity (up to 7 m)
- ◆ MSR function for eliminating light not reflected from the reflector
- ◆ Size-adjustable line and area beams

Long-distance and High-precision Sensing

E3C-LDA-series Photoelectric Sensors with Separate Digital Amplifiers (Laser Type)



High-precision Sensing and Simple Installation

- ◆ Parallel light kept at a constant diameter of 2 mm for up to 1 m
- ◆ Adjustment function for adjusting the optical axis

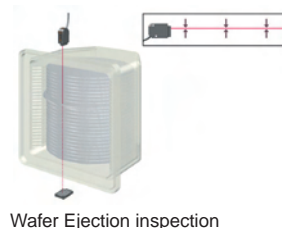







Ordering Information

Through-beam Fiber Units

*1. The values for the minimum sensing object are representative values that indicate values obtained in standard mode with the sensing distance and sensitivity set to optimum values.

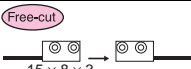
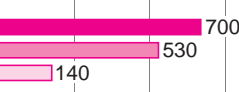
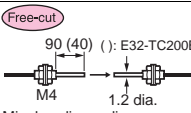
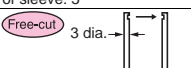
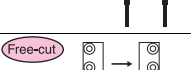
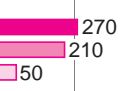
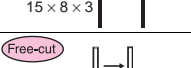
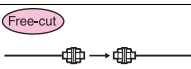
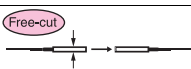
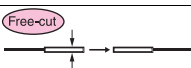
*2. **Free-cut** Indicates models that allow free cutting.

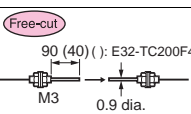
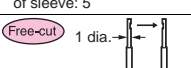
 High-resolution mode  Standard mode  Super-high-speed mode *When used in combination with the E3X-DA-S Amplifier Unit (general-purpose).

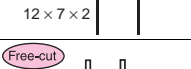
Type	Appearance (mm) *2	Sensing distance (mm)	Standard object (min. sensing object) (mm) *1	Min. bending radius (mm)	Features	Model number		
Standard models Flexible (new standard)	Standard size	 Free-cut M4				M4 screw	E32-T11R	
		 Free-cut 3 dia.				3-dia. cylinder	E32-T12R	
		 Free-cut 15 x 8 x 3		700 530 140	1 dia. (0.005 dia.)		Flat shape	E32-T15XR NEW
		 Free-cut 90 (40) (): E32-TC200B4R M4 1.2 dia. Min. bending radius of sleeve: 5				M4 screw, with sleeve	E32-TC200BR E32-TC200B4R NEW	
		 Free-cut 3 dia.				3-dia. cylinder, side-view	E32-T14LR	
		 Free-cut 15 x 8 x 3		270 210 50		Flat shape, side-view	E32-T15YR NEW	
		 Free-cut 15 x 8 x 3				Flat shape, flat-view	E32-T15ZR NEW	
	Small size	 Free-cut M3				M3 screw (small)	E32-T21R	
		 Free-cut 2 dia.				2-dia. cylinder (small)	E32-T22R	
		 Free-cut 1.5 dia.		160 130 30		1.5-dia. cylinder (small)	E32-T222R NEW	
		 Free-cut 12 x 7 x 2				Flat shape (small)	E32-T25XR NEW	
		 Free-cut 90 (40) (): E32-TC200F4R M3 0.9 dia. Min. bending radius of sleeve: 5				M3 screw (small), with sleeve	E32-TC200FR E32-TC200F4R NEW	
		 Free-cut 1 dia.				1-dia. cylinder (small), side-view	E32-T24R	
		 Free-cut 12 x 7 x 2		60 50 10		Flat shape (small), side-view	E32-T25YR NEW	
 Free-cut 12 x 7 x 2				Flat shape (small), flat-view	E32-T25ZR NEW			







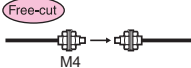

R
R1

Through-beam Fiber Units

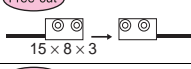
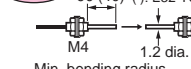
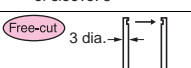
*1. The values for the minimum sensing object are representative values that indicate values obtained in standard mode with the sensing distance and sensitivity set to optimum values.

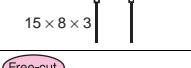
*2. **Free-cut** Indicates models that allow free cutting.

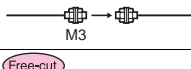
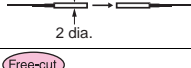
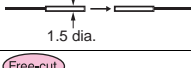
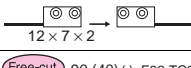
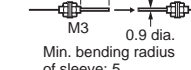
High-resolution mode Standard mode Super-high-speed mode *When used in combination with the E3X-DA-S Amplifier Unit (general-purpose).

Type	Appearance (mm) *2	Sensing distance (mm)	Standard object (min. sensing object) (mm) *1	Min. bending radius (mm)	Features	Model number		
Standard models	Standard size	Free-cut 			M4 screw	E32-TC200		
		Free-cut 			3-dia. cylinder	E32-T12 <i>NEW</i>		
		Free-cut 	15 × 8 × 3	1,000 760 200		Flat shape	E32-T15X <i>NEW</i>	
		Free-cut 	90 (40) (): E32-TC200B4R M4 1.2 dia. Min. bending radius of sleeve: 5			M4 screw, with sleeve	E32-TC200B E32-TC200B4	
		Free-cut 	3 dia.			3-dia. cylinder, side-view	E32-T14L	
		Free-cut 	15 × 8 × 3	600 460 120		Flat shape, side-view	E32-T15Y <i>NEW</i>	
		Free-cut 	15 × 8 × 3			Flat shape, flat-view	E32-T15Z <i>NEW</i>	
		Free-cut 		900 680 180		M3 screw (small)	E32-TC200A E32-TC200E	
		Free-cut 	2 dia.			2-dia. cylinder (small)	E32-T22	
		Free-cut 	1.5 dia.	270 220 50		1.5-dia. cylinder (small)	E32-T222 <i>NEW</i>	
	Small size	Free-cut 	12 × 7 × 2			Flat shape (small)	E32-T25X <i>NEW</i>	
		Free-cut 	90 (40) (): E32-TC200F4R M3 0.9 dia. Min. bending radius of sleeve: 5			M3 screw (small), with sleeve	E32-TC200F E32-TC200F4	
		Free-cut 	1 dia.			1-dia. cylinder (small), side-view	E32-T24	
		Free-cut 	12 × 7 × 2	160 130 30		Flat shape (small), side-view	E32-T25Y <i>NEW</i>	
		Free-cut 	12 × 7 × 2			Flat shape (small), flat-view	E32-T25Z <i>NEW</i>	
					1 dia. (0.005 dia.)	R25		
					0.5 dia. (0.005 dia.)	R10		

Through-beam Fiber Units

Type	Appearance (mm) *2	Sensing distance (mm)	Standard object (min. sensing object) (mm) *1	Min. bending radius (mm)	Features	Model number				
Standard models	Break-resistant	Standard size	 M4 900 680 180	B R4	M4 screw	E32-T11				
		 3 dia.			3-dia. cylinder	E32-T12B <i>NEW</i>				
					 15 × 8 × 3	Flat shape	E32-T15XB <i>NEW</i>			
			Small size			 M3 240 200 45	M3 screw (small)	E32-T21		
		 2 dia.			2-dia. cylinder (small)		E32-T221B <i>NEW</i>			
					 1.5 dia.		1.5-dia. cylinder (small)	E32-T22B		
	Coating	 M4 900 680 180	1 dia. (0.005 dia.)	U R4		M4 screw, fluorine coating	E32-T11U			
					Special-beam models	Long-distance, high-power	 M14 20,000*3 20,000*3 4,000	R25	Large built-in lens, M14 screw	E32-T17L
									 M4 4,000*4 4,000*4 1,500	M4 screw
								 M4 4,000*4 3,700 970		4 dia. (0.1 dia.)
 M4 4,000*4 3,600 930	B R4	M4 screw, break-resistant	E32-T11+ E39-F1							
		 4,000*4 3,400 900	R25	Screw mounting, side-view	E32-T14					
 M4 1,700 1,330 350	1.4 dia. (0.01 dia.)			R25	M4 screw		E32-T11L			
		 3 dia.	3-dia. cylinder		E32-T12L					

*3. The optical fiber is 10 m long on each side, so the sensing distance is 20,000 mm.











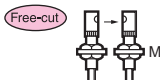









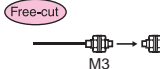

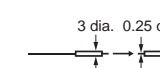
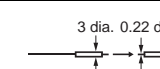
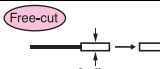
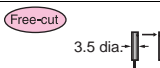
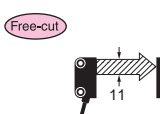
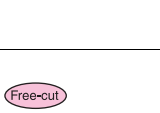
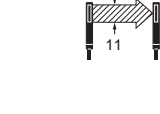

























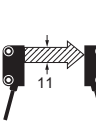



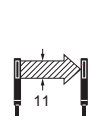

*4. The optical fiber is 2 m long on each side, so the sensing distance is 4,000 mm.

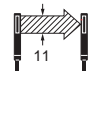
Through-beam Fiber Units

*1. The values for the minimum sensing object are representative values that indicate values obtained in standard mode with the sensing distance and sensitivity set to optimum values.







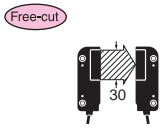
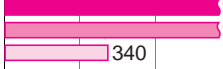

*2.  Indicates models that allow free cutting.

 High-resolution mode  Standard mode  Super-high-speed mode *When used in combination with the E3X-DA-S Amplifier Unit (general-purpose).

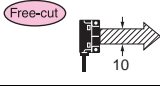
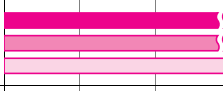
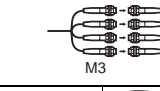
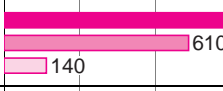
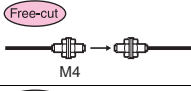
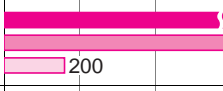
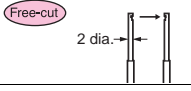
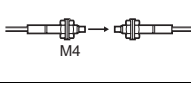
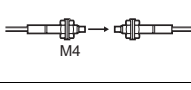
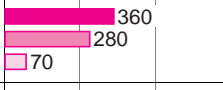
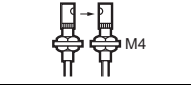
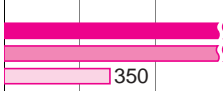
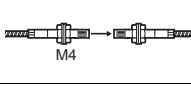
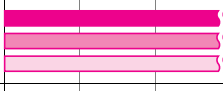
Type	Appearance (mm) *2	Sensing distance (mm)	Standard object (min. sensing object) (mm)*1	Min. bending radius (mm)	Features	Model number		
Special-beam models	Long-distance, high-power		 910	3 dia. (0.1 dia.)	R25	M4 screw, side-view	E32-T11L+ E39-F2	
			 800					
			 180					
					 520	R1	M4 screw, side-view, flexible fiber	E32-T11R+ E39-F2
					 400			
					 100			
	Ultracompact, thin-sleeve			 820	0.9 dia. (0.005 dia.)	R10	M4 screw, side-view, break-resistant	E32-T11+ E39-F2
				 660				
				 540		R10	M3 screw (small)	E32-T21L
				 440				
Fine-beam			 160	0.5 dia. (0.005 dia.)	R1	1-dia. cylinder, flexible fiber	E32-T223R NEW	
			 130					
			 30					
			Sleeve cannot be bent.	 53	0.25 dia. (0.005 dia.)	R10	0.5-dia. sleeve; 0.25-dia. opening	E32-T33-S5 NEW
				 44				
				 10				
		Sleeve cannot be bent.	 12	0.125 dia. (0.005 dia.)	R10	0.25-dia. sleeve, 0.125-dia. opening	E32-T333-S5 NEW	
			 10					
			 4					
		Sleeve cannot be bent.	 6	0.1 dia. (0.005 dia.)	R10	0.22-dia. sleeve, 0.1-dia. opening	E32-T334-S5 NEW	
			 5					
			 2					
Area-sensing			 2,500	1.7 dia. (0.1 dia.)	R10	3-dia. cylinder	E32-T22S	
			 1,900					
			 1,750	2 dia. (0.1 dia.)		3.5-dia. cylinder, side-view	E32-T24S	
			 1,300					
Area-sensing			 1,100	(0.2 dia.) *3	R1	Area width: 11 mm	E32-T16PR	
			 840					
			 220					
			 1,500		R10	Area width: 11 mm	E32-T16P	
			 1,100					
			 300					
		 980	R1	Area width: 11 mm; side-view	E32-T16JR			
		 750						
		 190						
		 1,300	R10	Area width: 11 mm; side-view	E32-T16J			
		 1,000						
		 260						

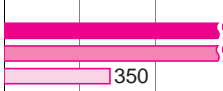
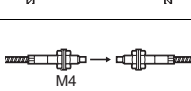
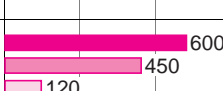
*3. This is the value for which detection is possible within the sensing area, with the sensing distance set to 300 mm. (The sensing object is stationary.)

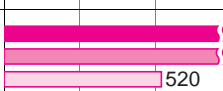
Through-beam Fiber Units

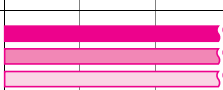
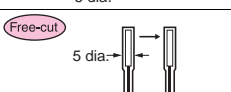
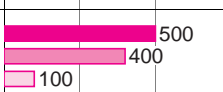
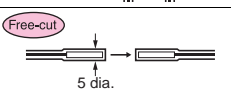
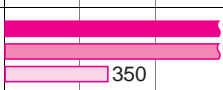
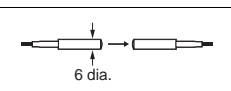
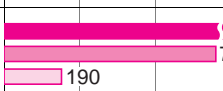
Type	Appearance (mm) *2	Sensing distance (mm)	Standard object (min. sensing object) (mm)*1	Min. bending radius (mm)	Features	Model number	
Special-beam models	Area-sensing 		(0.3 dia.) *3	R1	Area width: 30 mm	E32-T16WR	
			R10			E32-T16W	
			(0.6 dia.) *4	R25	Area width: 10 mm; long distance	E32-T16	
			2 dia. (0.1 dia.)		Multi-point detection (4-head)	E32-M21	
Environment-resistive models	Heat-resistant 150°C*5 		1.5 dia. (0.1 dia.)	R35	Heat-resistant up to 150°C	E32-T51	
						Heat-resistant up to 150°C; side-view	E32-T54
	200°C*6 		1 dia. (0.005 dia.)	R10	Heat-resistant up to 200°C	E32-T81R-S	
				3 dia. (0.1 dia.)	R25	Heat-resistant up to 200°C; side-view	E32-T61-S+ E39-F2
				4 dia. (0.1 dia.)		Heat-resistant up to 200°C, long distance	E32-T61-S+ E39-F1
				1.7 dia. (0.1 dia.)		Heat-resistant up to 200°C; L-shaped; long distance	E32-T84S-S
	350°C*6 		1 dia. (0.005 dia.)		Heat-resistant up to 350°C	E32-T61-S	
	Chemical-resistant			4 dia. (0.1 dia.)	R4	Fluororesin cover, round head	E32-T11F
						Fluororesin cover, long distance	E32-T12F
				3 dia. (0.1 dia.)	R40	Fluororesin cover, side-view	E32-T14F
			4 dia. (0.1 dia.)	Fluororesin cover, heat-resistant up to 150°C *5		E32-T51F NEW	
			1 dia. (0.005 dia.)	R10	Fluororesin cover, heat-resistant up to 200°C *6	E32-T81F-S	



















*4. This is the value for which detection is possible within the sensing area, with the sensing distance set to give a digital value of 1,000. (The sensing object is stationary.)
 *5. For continuous operation, use the products within a temperature range of -40°C to 130°C.
 *6. The maximum temperature that can be withstood varies with the location. Refer to dimensions diagrams for details.
 *7. The optical fiber is 2 m long on each side, so the sensing distance is 4,000 mm.

Through-beam Fiber Units



*1. The values for the minimum sensing object are representative values that indicate values obtained in standard mode with the sensing distance and sensitivity set to optimum values.

*2.  Indicates models that allow free cutting.

 High-resolution mode  Standard mode  Super-high-speed mode *When used in combination with the E3X-DA-S Amplifier Unit (general-purpose).

Type	Appearance (mm) *2	Sensing distance (mm)	Standard object (min. sensing object) (mm) *1	Min. bending radius (mm)	Features	Model number
Environment-resistant models Vacuum-resistant		 260  200  50	1.2 dia. (0.01 dia.)	R30	M4 screw, heat-resistant up to 120°C	E32-T51V 1M
		 1,350  1,000  260	4 dia. (0.1 dia.)		M4 screw, heat-resistant up to 120°C, long distance	E32-T51V 1M+ E39-F1V
		 210  130  35	1.2 dia. (0.01 dia.)	R25	L-shaped, heat-resistant up to 120°C	E32-T54V 1M
		 660  500  180	4 dia. (0.1 dia.)		L-shaped, heat-resistant up to 120°C, long distance	E32-T54V 1M+ E39-F1V
		 630  480  130	2 dia. (0.1 dia.)		L-shaped, heat-resistant up to 200°C, long distance	E32-T84SV 1M

Flanges

Appearance (mm)	Type	Model number
	4-channel flange	E32-VF4
	1-channel flange	E32-VF1



Lens Units

Appearance (mm)	Type	Quantity	Remarks
	E39-F1V	2	Long-distance Lens Unit Can be used for the E32-T51V and the E32-T54V.

Mounting Brackets

Appearance (mm)	Type	Quantity	Remarks
	E39-L54V	2	Can be used for the E32-T54V.

Fiber Units for Atmospheric-pressure Side

Appearance (mm)	Type	Model number
 	Amplifier-Flange Connection Fiber	E32-T10V 2M

Ordering Information

Fiber Units with Reflective Sensors

- *1. The sensing distances are for white paper.
- *2. The values for the minimum sensing object are representative values that indicate values obtained in standard mode with the sensing distance and sensitivity set to optimum values.
- *3. **Free-cut** Indicates models that allow free cutting.

High-resolution mode
 Standard mode
 Super-high-speed mode
 *When used in combination with the E3X-DA-S Amplifier Unit (general-purpose).

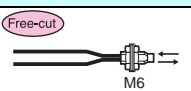
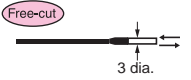
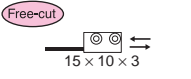
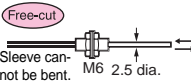
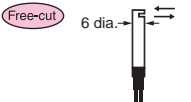
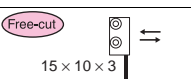
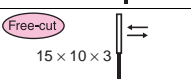
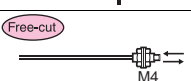
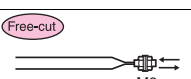
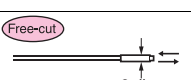
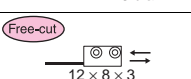
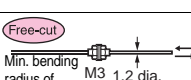
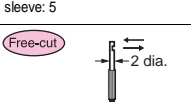
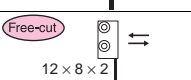
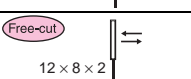
Type	Appearance (mm) *3	Sensing distance (mm) *1	(Min. sensing object) (mm) *2	Min. bending radius (mm)	Features	Model number		
Standard models Flexible (new standard)	Standard size	 (Free-cut) M6			M6 screw	E32-D11R		
		 (Free-cut) 3 dia.	 300 170 50		3-dia. cylinder	E32-D12R		
		 (Free-cut) 15 × 10 × 3			Flat shape	E32-D15XR <i>NEW</i>		
		 (Free-cut) Sleeve cannot be bent. M6 2.5 dia.			M6 screw, with sleeve	E32-DC200BR E32-DC200B4R <i>NEW</i>		
		 (Free-cut) 6 dia.	 80 45 14		6-dia. cylinder, side-view	E32-D14LR		
		 (Free-cut) 15 × 10 × 3	 70 40 12		Flat shape, side-view	E32-D15YR <i>NEW</i>		
		 (Free-cut) 15 × 10 × 3			Flat shape, flat-view	E32-D15ZR <i>NEW</i>		
		Small size	 (Free-cut) M4		(0.005 dia.)	R R1	M4 screw (small)	E32-D211R <i>NEW</i>
			 (Free-cut) M3				M3 screw (small)	E32-D21R
	 (Free-cut) 3 dia.		 50 30 8		3-dia. cylinder (small)		E32-D22R	
	 (Free-cut) 12 × 8 × 3				Flat panel (small)		E32-D25XR <i>NEW</i>	
	 (Free-cut) Min. bending radius of sleeve: 5 M3 1.2 dia.				M3 screw (small), with sleeve		E32-DC200FR E32-DC200F4R <i>NEW</i>	
	 (Free-cut) 2 dia.		 26 15 4		2-dia. cylinder (small), side-view		E32-D24R	
	 (Free-cut) 12 × 8 × 2		 14 8 2		Flat shape (small), side-view		E32-D25YR <i>NEW</i>	
	 (Free-cut) 12 × 8 × 2				Flat shape (small), flat-view		E32-D25ZR <i>NEW</i>	



Fiber Units with Reflective Sensors

- *1. The sensing distances are for white paper.
- *2. The values for the minimum sensing object are representative values that indicate values obtained in standard mode with the sensing distance and sensitivity set to optimum values.
- *3. **Free-cut** Indicates models that allow free cutting.

High-resolution mode Standard mode Super-high-speed mode *When used in combination with the E3X-DA-S Amplifier Unit (general-purpose).

Type	Appearance (mm) *3	Sensing distance (mm) *1	(Min. sensing object) (mm) *2	Min. bending radius (mm)	Features	Model number				
Standard models	Standard	Standard size	(0.005 dia.)	R25	M6 screw	E32-DC200				
					3-dia. cylinder	E32-D12				
					Flat shape	E32-D15X NEW				
					M6 screw, with sleeve	E32-DC200B E32-DC200B4				
					6-dia. cylinder, side-view	E32-D14L				
					Flat shape, side-view	E32-D15Y NEW				
					Flat shape, flat-view	E32-D15Z NEW				
					Small size	Small size	(0.005 dia.)	R10	M4 screw (small)	E32-D211 NEW
									M3 screw (small)	E32-DC200E
	3-dia. cylinder (small)	E32-D22 NEW								
	Flat shape (small)	E32-D25X NEW								
	M3 screw (small), with sleeve	E32-DC200F E32-DC200F4								
	2-dia. cylinder (small), side-view	E32-D24								
	Flat shape (small), side-view	E32-D25Y NEW								
	Flat shape (small), flat-view	E32-D25Z NEW								

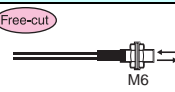
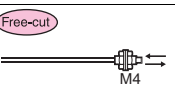
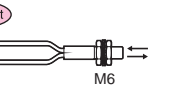
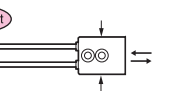
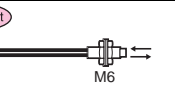

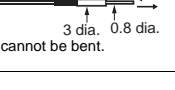







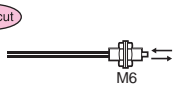

















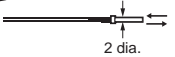



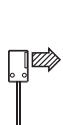





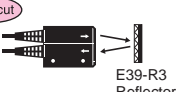

Fiber Units with Reflective Sensors

Type	Appearance (mm) *3	Sensing distance (mm) *1	(Min. sensing object) (mm) *2	Min. bending radius (mm)	Features	Model number				
Standard models	Break-resistant	Standard size  Free-cut M6	300	(0.005 dia.)	B R4	M6 screw	E32-D11			
			170			Flat shape	E32-D15XB <i>NEW</i>			
		50	M4 screw (small)			E32-D21B				
		Small size  Free-cut 3 dia.				110	3-dia. cylinder (small)	E32-D221B <i>NEW</i>		
			70			M3 screw (small)	E32-D21			
		20	1.5-dia. cylinder (small)				E32-D22B			
		Coating	 Free-cut M6			300	(0.005 dia.)	U R4	M6 screw, fluorine coating	E32-D11U
	170				Special-beam models	B R4	Large built-in lens, screw mounting	E32-D16		
	50									
	Long-distance, high-power	 Free-cut 17.5	40 to 1,000				---	R25	M6 screw	E32-D11L
40 to 700			R10	M4 screw			E32-D21L			
40 to 240						3-dia. cylinder				
Ultracompact, thin-sleeve	 Free-cut 3 dia. 0.8 dia. Sleeve cannot be bent.	650	(0.005 dia.)	R4		0.8-dia. sleeve	E32-D33			
		400						R4	0.5-dia. sleeve	E32-D331
		110								
		M4 screw						210		
130										
35										
Ultracompact, thin-sleeve	 Free-cut 3 dia. 0.5 dia. Sleeve cannot be bent.	25	(0.005 dia.)	R4	0.8-dia. sleeve	E32-D33				
		16								
Ultracompact, thin-sleeve	 Free-cut 2 dia. 0.5 dia. Sleeve cannot be bent.	4	(0.005 dia.)	R4	0.5-dia. sleeve	E32-D331				
		5								
Ultracompact, thin-sleeve	 Free-cut 2 dia. 0.5 dia. Sleeve cannot be bent.	3	(0.005 dia.)	R4	0.5-dia. sleeve	E32-D331				
		0.8								

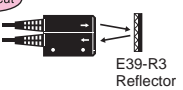

Fiber Units with Reflective Sensors

- *1. The sensing distances are for white paper.
- *2. The values for the minimum sensing object are representative values that indicate values obtained in standard mode with the sensing distance and sensitivity set to optimum values.
- *3.  Indicates models that allow free cutting.

 High-resolution mode  Standard mode  Super-high-speed mode *When used in combination with the E3X-DA-S Amplifier Unit (general-purpose).

Type	Appearance (mm) *3	Sensing distance (mm) *1	(Min. sensing object) (mm) *2	Min. bending radius (mm)	Features	Model number	
Special-beam models	Coaxial, small-spot	  M6	 250  150  45	(0.005 dia.)	R4	M6 screw	E32-CC200R NEW
			 500  300  90				E32-CC200
		  3 dia.	 250  150  45			3-dia. cylinder	E32-D32L
		  M3	 120  75  22			M3 screw (small)	E32-C31
	  2 dia.		2-dia. cylinder (small)		E32-D32		
		6 to 15 mm; spot diameter: 0.1 to 0.6 mm Spot diameter of 0.5 to 1 mm at distances in the range 6 to 15 mm 	Small spot (variable)		E32-C42+ E39-F3A		
		Spot diameter of 0.1 mm at 7 mm Spot diameter of 0.5 mm at 7 mm 	Small spot		E32-C41+ E39-F3A-5		
		Spot diameter of 0.2 mm at 17 mm Spot diameter of 0.5 mm at 17 mm 	Long distance, small spot		E32-C41+ E39-F3B		
	  4-dia. spot	Spot diameter of 4 mm max. at distances in the range 0 to 20 mm	Long-distance sensing, parallel light		E32-C31+ E39-F3C		
	Area-sensing	 	 250  150  45		(0.005 dia.)	B4	Beam width: 11 mm
Retroreflective	  M6 E39-R3 Reflector	 10 to 250  10 to 250  10 to 250	(0.1 dia.)	R10	M6 screw	E32-R21+ E39-R3 (Attached)	
	  E39-R3 Reflector	 150 to 1,500  150 to 1,500  150 to 1,500	(0.2 dia.)	R25	Screw mounting, long distance	E32-R16+ E39-R1 (Attached)	

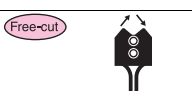
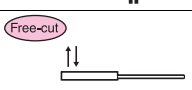
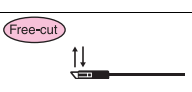
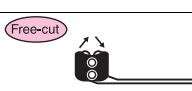
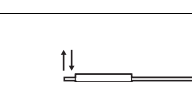
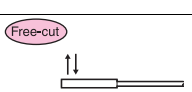
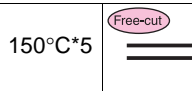
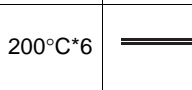
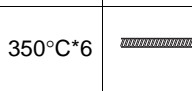
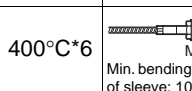
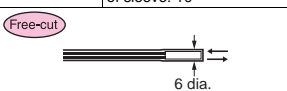
Fiber Units with Reflective Sensors

Type	Appearance (mm) *3	Sensing distance (mm) *1	(Min. sensing object) (mm) *2	Min. bending radius (mm)	Features	Model number	
Special-beam models	Limited-reflective	 3.3		(0.005 dia.)	Small level differences, high power, side-view	E32-L25	
		 3.3					Small level differences, top-view
		 0 to 4	0 to 4		R10	Ultracompact, flat-view	E32-L24S
		 2 to 6 (center: 4)	2 to 6 (center: 4)			Heat resistant up to 105°C *4, top-view	E32-L24L
		 5.4 to 9 (center: 7.2)	5.4 to 9 (center: 7.2)			Heat resistant up to 105°C *4, top-view	E32-L25L
		 4 to 10	4 to 10		R25	Heat resistant up to 200°C, flat-view	E32-L86 NEW
		 0 to 15	0 to 15			Wide-range sensing, flat-view	E32-L16
Environment-resistant models	Heat-resistant	 150°C*5	400 230 72	(0.005 dia.)	Heat resistant up to 150°C	E32-D51	
		 200°C*6	150 90		R10	Heat resistant up to 200°C	E32-D81R-S E32-D81R
		 350°C*6	27		R25	Heat resistant up to 350°C	E32-D61-S E32-D61
		 400°C*6	100 60 18			Heat resistant up to 400°C, with sleeve	E32-D73-S E32-D73
	Chemical-resistant	 6 dia.	160 95 30	(0.005 dia.)	Fluororesin cover, long distance	E32-D12F	
		 6 dia.	70 40 10		R40	Fluororesin cover, side-view	E32-D14F NEW

*4. For continuous operation, use the products within a temperature range of -40°C to 90°C.

*5. For continuous operation, use the products within a temperature range of -40°C to 130°C.

*6. The maximum temperature that can be withstood varies with the location. Refer to dimensions diagrams for details.



















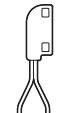



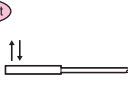

Ordering Information

Application-specific Fiber Units

*1. The values for the minimum sensing object are representative values that indicate values obtained in standard mode with the sensing distance and sensitivity set to optimum values.

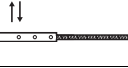
*2.  Indicates models that allow free cutting.

 High-resolution mode  Standard mode  Super-high-speed mode *When used in combination with the E3X-DA-S Amplifier Unit (general-purpose).

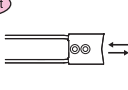
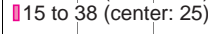
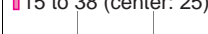
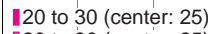
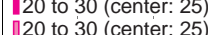
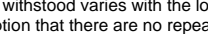
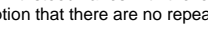

Type	Appearance (mm) *2	Sensing distance (mm)	Standard object (min. sensing object) (mm)*1	Min. bending radius (mm)	Features	Model number	
Application-specific models	 	 10  10  10	4 dia. (0.1 dia.)	R25	Slot sensor (no adjustment of optical axis required)	E32-G14	
		 4,500  3,400  900			Screw mounting, side-view	E32-T14	
		Applicable tube: Transparent tube with a diameter in the range 8 to 10 mm and a recommended wall thickness of 1 mm	R10	Compact	E32-L25T		
		Applicable tube: Transparent tube (no restriction on diameter)	R4	No restriction on tube diameter, resistant to bubbles and drops of water	E32-D36T NEW		
		Applicable tube: Transparent tube with a diameter of 3.2, 6.4, or 9.5 mm and a recommended wall thickness of 1 mm		Light ON when fluid is present, resistant to bubbles and drops of water	E32-A01		
		Applicable tube: Transparent tube with a diameter in the range 6 to 13 mm and a recommended wall thickness of 1 mm		Light ON when fluid is not present, resistant to bubbles and drops of water	E32-A02		
		Liquid-contact models	R40	Heat resistant up to 200°C, fluororesin cover	E32-D82F1 E32-D82F2		
	Glass-substrate-alignment		 0 to 15  0 to 15  0 to 12	Soda glass with reflection factor of 7%	R25	Variation of detection position within the detection range: 0.2 mm	E32-L16
			 10 to 20  10 to 20				E32-A08 NEW
			 15 to 25  15 to 25				E32-A07E1 E32-A07E2 NEW
		 5 to 18  5 to 18  5 to 15	R25	Heat resistant up to 300°C *4, *5	E32-L66		
	Glass-substrate-mapping		 15 to 38 (center: 25)  15 to 38 (center: 25)	Edge of soda glass with reflection factor of 7% (t = 0.5 mm, rounded edge)	R25	Resistant to tilting	E32-A09 NEW
			 20 to 30 (center: 25)  20 to 30 (center: 25)		R35	Heat resistant up to 150°C *3	E32-A09H NEW
			 20 to 30 (center: 25)  20 to 30 (center: 25)		R25	Heat resistant up to 300°C *4, *5	E32-A09H2 NEW

*3. For continuous operation, use the products within a temperature range of -40°C to 130°C.

*4. The maximum temperature that can be withstood varies with the location. Refer to dimensions diagrams for details.

*5. These values are based on the assumption that there are no repeated sudden changes in temperature.

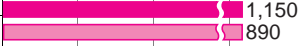
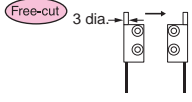
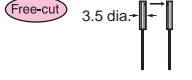
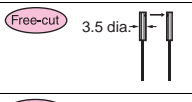

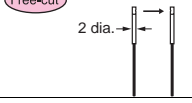
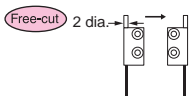
Application-specific Fiber Units

Type	Appearance (mm) *2	Sensing distance (mm)	Standard object (min. sensing object) (mm)*1	Min. bending radius (mm)	Features	Model number
Application-specific models Wafer-mapping			2 dia. (0.1 dia.)	R1	Opening angle: 1.5°; optical axis adjusted before delivery	E32-A03
					Opening angle: 1.5°; with mounting flange; optical axis adjusted before delivery	E32-A03-1 <i>NEW</i>
					1.2 dia. (0.1 dia.)	R10
			Ultraslim (t = 2 mm); opening angle: 3°; optical axis adjusted before delivery	E32-A04		
			Ultraslim (t = 2 mm); opening angle: 3°; with mounting flange; optical axis adjusted before delivery	E32-A04-1 <i>NEW</i>		

Accessories

*1. The values for the minimum sensing object are representative values that indicate values obtained in standard mode with the sensing distance and sensitivity set to optimum values.

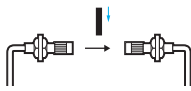
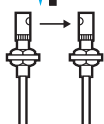

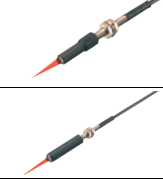
Lens Units

Type	Appearance	Applicable Fiber Units	Sensing distance (mm)			Standard object (min. sensing object) (mm) *1	Features	Model number
			High-resolution mode	Standard mode	Super-high-speed			
Through-beam Lens Units	 <p>Long-distance Lens Units</p>	E32-T11L	4,000*2	3,200	840	4 dia. (0.1 dia.)	Long-distance sensing; opening angle: 5°C to 40°C (heat resistant up to 200°C)	E39-F1
		E32-TC200	4,000*2	4,000*2	1,500			
		E32-T11R	4,000*2	3,700	970			
		E32-T11	4,000*2	3,600	930			
		E32-T11U	4,000*2	3,600	930			
		E32-T81R-S	2,650	2,100	520			
		E32-T61-S	4,000*2	3,400	900			
	 <p>Side-view Units</p>	E32-T11L	910	800	180	3 dia. (0.1 dia.)	Side-view, space-saving (heat resistant up to 200°C)	E39-F2
		E32-TC200	840	700	160			
		E32-T11R	520	400	100			
		E32-T11	820	660	160			
		E32-T11U	820	660	160			
		E32-T81R-S	360	280	70			
		E32-T61-S	600	450	120			
	 <p>Reflection Units</p>	E32-T11L E32-TC200 E32-T11R E32-T11 E32-T11U E32-T81R-S E32-T61-S	---	---	---	---	Long distance reflection (heat resistant up to 200°C)	E39-F3
	Reflective Lens Units	 <p>Small-spot Lens Units</p>	E32-C42	Spot diameter variable in the range 0.1 to 0.6 mm at distances in the range 6 to 15 mm			Small spot (variable)	E39-F3A
			E32-D32	Spot diameter variable in the range 0.5 to 1 mm at distances in the range 6 to 15 mm				
			E32-C41	0.1-dia. spot at a distance of 7 mm			Small spot	E39-F3A-5
			E32-C31	0.5-dia. spot at a distance of 7 mm				
E32-C41			0.2-dia. spot at a distance of 17 mm			Long distance, small spot	E39-F3B	
E32-C31			0.5-dia. spot at a distance of 17 mm					
E32-C31 E32-C41			Spot diameter of 4 mm max. at distances in the range 0 to 20 mm			Long-distance sensing, parallel light	E39-F3C	

*2. The optical fiber is 2 m long on each side, so the sensing distance is 4,000 mm.





Accessories

Protective Spiral Tube

Appearance	Application	Applicable Fiber Units	Tube length	Model number
	Fiber protection	M3-screw models E32-D21□ E32-DC200E E32-DC200F□ E32-C31	500 mm	E39-F32A5
			1 m	E39-F32A
		M3-screw models E32-T21□ (Except the E32-T21R.) E32-TC200E E32-TC200F□	500 mm	E39-F32B5
			1 m	E39-F32B
		M4-screw models E32-T11□ E32-TC200 E32-TC200B□ E32-T51	500 mm	E39-F32C5
			1 m	E39-F32C
		M6-screw models E32-D11□ E32-DC200 E32-DC200B E32-CC200□ E32-D51	500 mm	E39-F32D5
			1 m	E39-F32D

Note: Before using a Protective Spiral Tube, remove the protective tube that protects the area between the head and the optical fiber provided with some models.

Other Accessories

Appearance	Application	Name	Applicable Fiber Units	Remarks	Model number
	Used to cut the fiber.	Cutter	Fiber Units that allow free cutting	Provided with applicable Fiber Units.	E39-F4
	Attachments for inserting thin fibers into Amplifier Units	Thin-fiber Attachments	Fiber Units that allow free cutting and have a 1.0-dia. sheath	<ul style="list-style-type: none"> • 2 per set • Provided with applicable Fiber Units. 	E39-F9
	Used to extend fibers.		Fiber Units that allow free cutting and have a 2.2-dia. sheath	---	E39-F10
	Easy-to-use, one-touch relay connectors	Fiber Connectors	Fiber Units that allow free cutting	E39-F13: Used for Fiber Units with a 2.2-dia. sheath. E39-F14: Used for Fiber Units with a 1.0-dia. sheath. E39-F15: Used for Fiber Units with a sheath diameter between 1.0 and 2.2 mm.	E39-F13 E39-F14 E39-F15
	Used to bends in sleeves.	Sleeve Bender	E32-TC200B(4) E32-TC200F(4) E32-DC200F(4)	---	E39-F11

Ratings/Characteristics

Fiber Units

Item	Type	Standard models				
		Flexible		Standard	Break-resistant	Fluorine-coating
		E32-T1□R E32-D1□R	E32-T2□R E32-D2□R			
Ambient operating temperature *1	-40°C to 70°C					
Ambient humidity *1	35% to 85%					
Fiber material	Plastic (PVC coating)	Plastic (polyethylene coating)		Plastic (PVC coating)	Plastic (fluororesin coating)	
Degree of protection	IEC standard: IP67					

Item	Type	Special-beam models				
		Long-distance, high-power		Ultracompact, ultrafine-sleeve	Coaxial, small-spot	Fine-beam (narrow vision field)
		All other models	E32-D16			
Ambient operating temperature *1	-40°C to 70°C					
Ambient humidity *1	35% to 85%					
Fiber material	Plastic (polyethylene coating)	Plastic (PVC coating)	Plastic (combination of PVC, polyethylene, and polyolefin sheaths)		Plastic (PVC coating)	
Degree of protection	IEC standard: IP67	IEC standard: IP40	IEC standard: IP67			

Item	Type	Special-beam models			
		Area-sensing		Retroreflective	
		All other models	E32-D36P1 E32-T16	E32-T16W(R)	E32-R21
Ambient operating temperature *1	-40°C to 70°C		-25°C to 55°C	-40°C to 70°C	-25°C to 55°C
Ambient humidity *1	35% to 85%				
Fiber material	Plastic (PVC coating)	Plastic (polyethylene coating)	Plastic (PVC coating)	Plastic (polyethylene coating)	
Degree of protection	IEC standard: IP50 (IP67 for E32-T16)			IEC standard: IP67	IEC standard: IP66

Item	Type	Special-beam models		
		Limited-reflective		
		All other models	E32-L25L E32-L24L	E32-L86
Ambient operating temperature *1	-40°C to 70°C		-40°C to 105°C *2	-40°C to 200°C *3
Ambient humidity *1	35% to 85%			
Fiber material	Plastic (polyethylene coating)			Glass (SUS spiral coating)
Degree of protection	IEC standard: IP50 (IP40 for E32-L24S, E32-L16, and E32-L86)			

*1. There must be no icing or condensation within the range specified for the ambient operating temperature.

*2. For continuous operation, use the products within a temperature range of -40°C to 90°C.

*3. The maximum temperature that can be withstood varies with the location. Refer to dimensions diagrams for details.

Fiber Units

Item	Type	Environment-resistive models				
		Heat-resistant				
		E32-T5□ E32-D5□	E32-T8□R-S E32-D8□R-S	E32-T84S-S	E32-T6□-S E32-D6□-S	E32-D73-S
Ambient operating temperature *1	-40°C to 150°C *4	-40°C to 200°C *3		-60°C to 350°C *3	-40°C to 400°C *3	
Ambient humidity *1	35% to 85%					
Fiber material	Plastic (fluororesin coating)	Glass (fluororesin coating)	Glass (SUS spiral coating)			
Degree of protection	IEC standard: IP67					

Item	Type	Environment-resistive models				
		Chemical-resistant			Vacuum-resistant	
		All other models	E32-T51F	E32-T81F-S	All other models	32-T84SV
Ambient operating temperature *1	-40°C to 70°C	-40°C to 150°C *4	-40°C to 200°C *3	-25°C to 120°C	-25°C to 200°C	
Ambient humidity *1	35% to 85%					
Fiber material	Plastic (fluororesin cover)		Glass (fluororesin cover)	Glass (fluororesin coating)	Glass (SUS spiral coating)	
Degree of protection	IEC standard: IP67			---		

Item	Type	Application-specific models				
		Label-detection	Liquid-level detection			Wafer-mapping
			All other models	E32-A01 E32-A02	E32-D82F	
Ambient operating temperature *1	-40°C to 70°C			-40°C to 200°C *3	-40°C to 70°C	
Ambient humidity *1	35% to 85%					
Fiber material	Plastic (polyethylene coating)		Plastic (fluororesin coating)	Fluororesin cover	Plastic (polyethylene coating)	
Degree of protection	IEC standard: IP67	IEC standard: IP50		IEC standard: IP68	IEC standard: IP50	
Other		Repeat accuracy: 1 mm max.		Repeat accuracy: 0.5 mm max.		

Item	Type	Application-specific models				
		Glass-substrate-alignment		Glass-substrate-mapping		
		All other models	E32-L66	E32-A09	E32-A09H	E32-A09H2
Ambient operating temperature *1	-40°C to 70°C	0°C to 300°C *3, *5	-40°C to 70°C	-40°C to 150°C *4	-40°C to 300°C *3	
Ambient humidity *1	35% to 85%					
Fiber material	Plastic (polyethylene coating)	Glass (SUS spiral coating)	Plastic (polyethylene coating)	Plastic (fluororesin coating)	Glass (SUS spiral coating)	
Degree of protection	IEC standard: IP40					

*1. There must be no icing or condensation within the range specified for the ambient operating temperature.

*2. For continuous operation, use the products within a temperature range of -40°C to 90°C.

*3. The maximum temperature that can be withstood varies with the location. Refer to dimensions diagrams for details.

*4. For continuous operation, use the products within a temperature range of -40°C to 130°C.

*5. These values are based on the assumption that there are no repeated sudden changes in temperature.

Dimensions

Through-beam Fiber Units

Standard/Flexible Models

Free-cut Indicates models that allow free cutting.

E32-TC200
E32-T11R

Free-cut

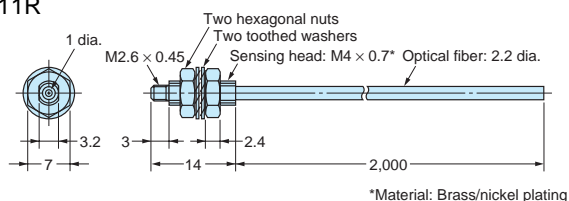

E32-TC200E

Free-cut

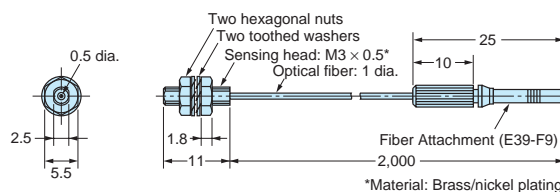

E32-TC200A
E32-T21R

Free-cut

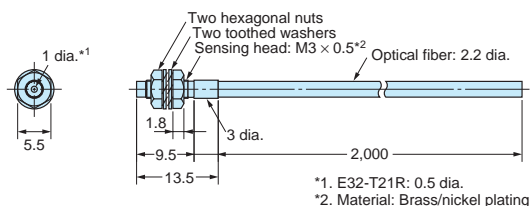

E32-T22
E32-T22R

Free-cut

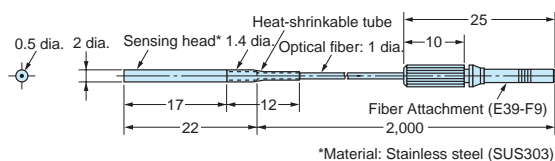

E32-T12
E32-T12R

Free-cut

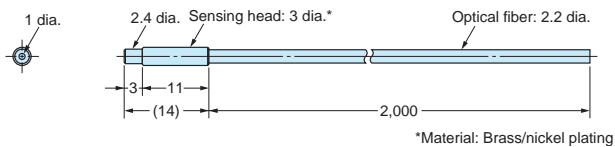

E32-T222
E32-T222R

Free-cut

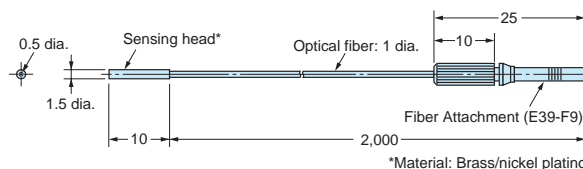

E32-T15X
E32-T15XR

Free-cut

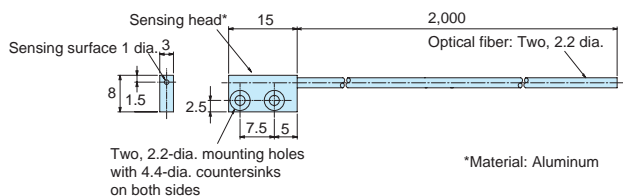

E32-T25X
E32-T25XR

Free-cut

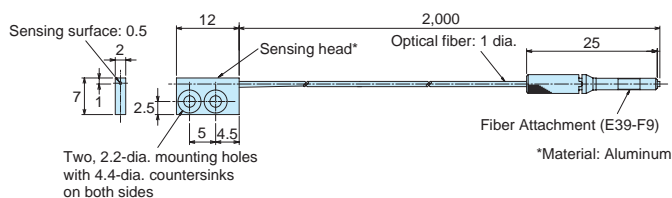

E32-TC200B(B4)
E32-TC200BR(B4R)

Free-cut

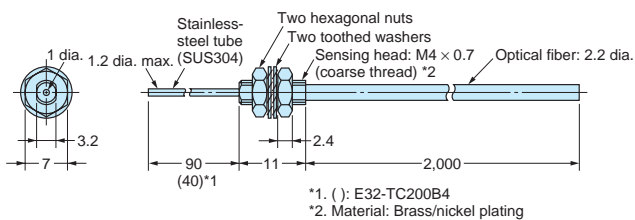

E32-TC200(F4)
E32-TC200F(F4R)

Free-cut

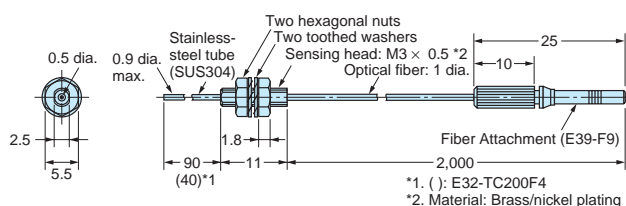

E32-T14L
E32-T14LR

Free-cut

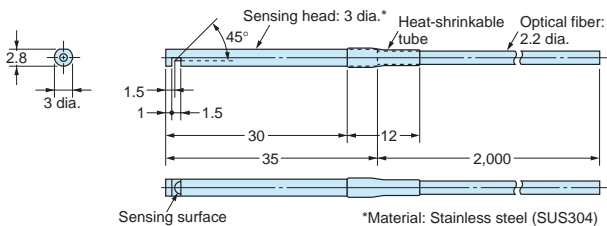

E32-T24
E32-T24R

Free-cut

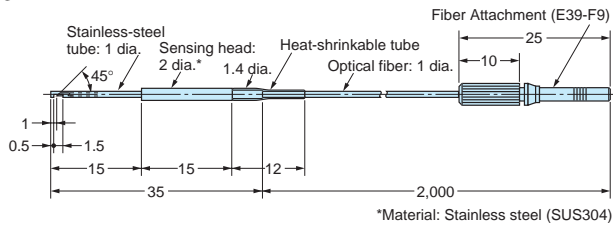

Through-beam Fiber Units
Standard/Flexible Models

E32-T15Y
E32-T15YR

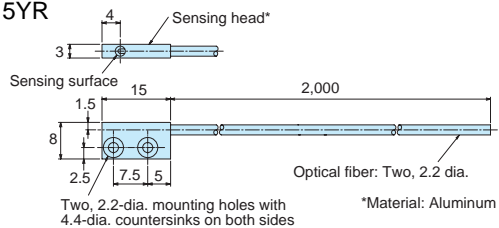

Free-cut

E32-T25Y
E32-T25YR

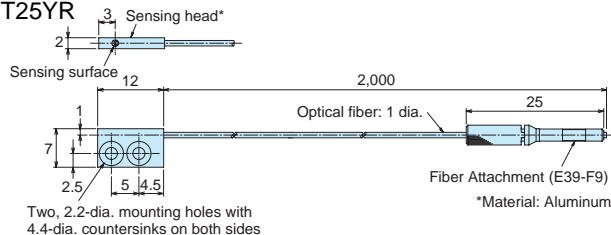

Free-cut

E32-T15Z
E32-T15ZR

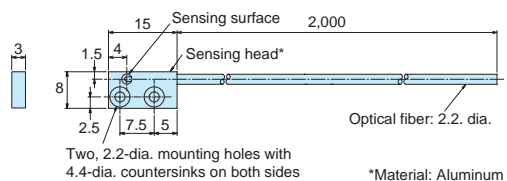

Free-cut

E32-T25Z
E32-T25ZR

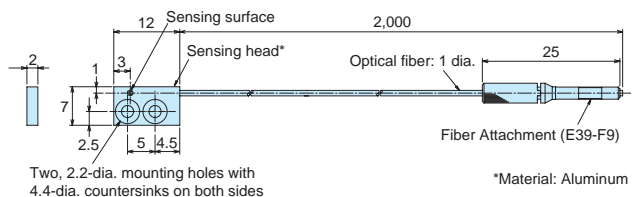

Free-cut

Break-resistant/Coated Models

E32-T11
E32-T11U

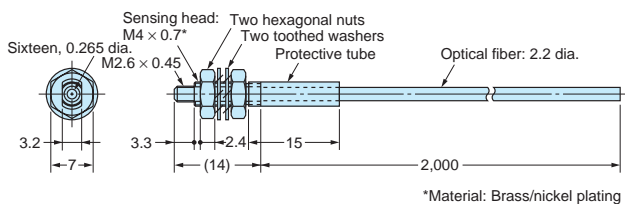

Free-cut

E32-T21

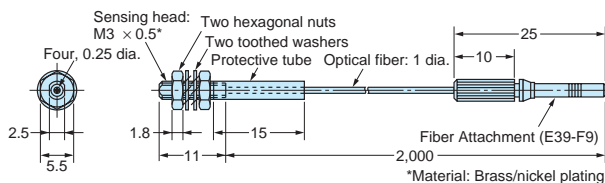

Free-cut

E32-T12B

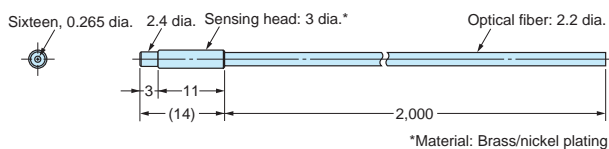

Free-cut

E32-T221B

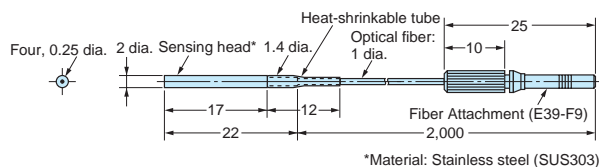

Free-cut

E32-T22B

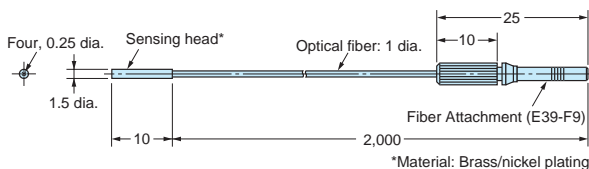

Free-cut

E32-T15XB

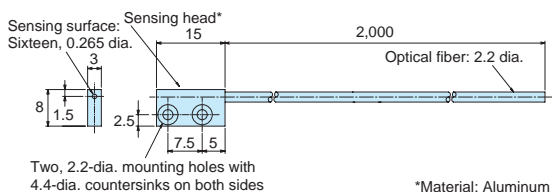

Free-cut

E32-T25XB

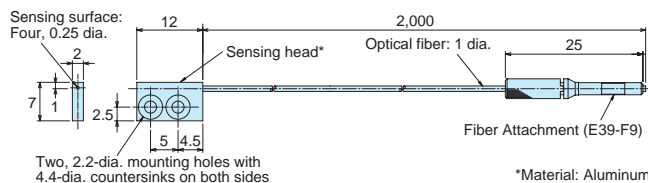

Free-cut

Through-beam Fiber Units
Long-distance/High-power Models

Free-cut Indicates models that allow free cutting.

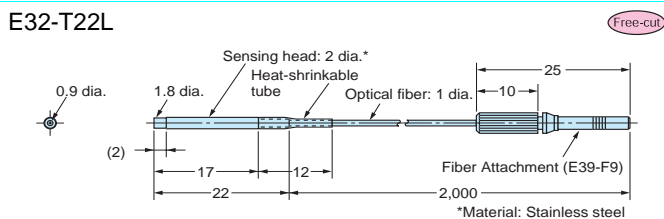
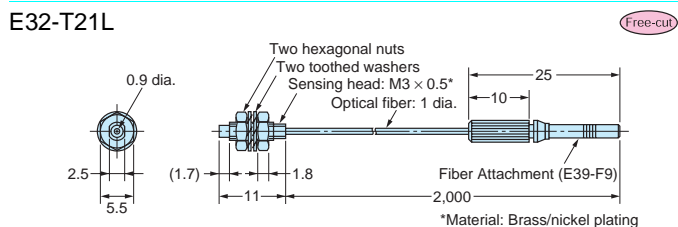
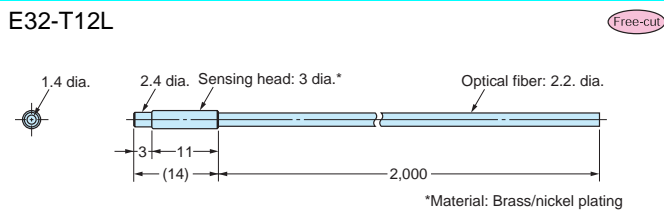
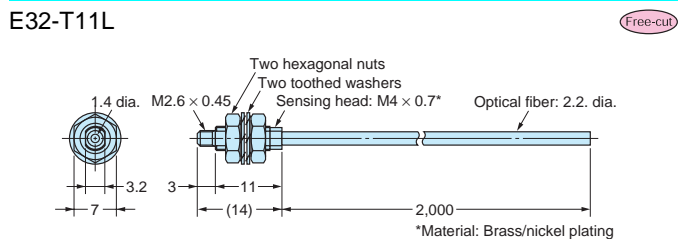
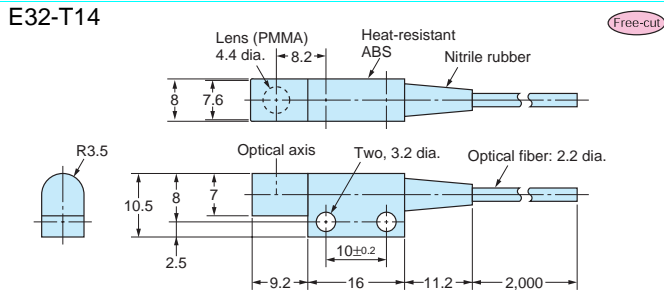
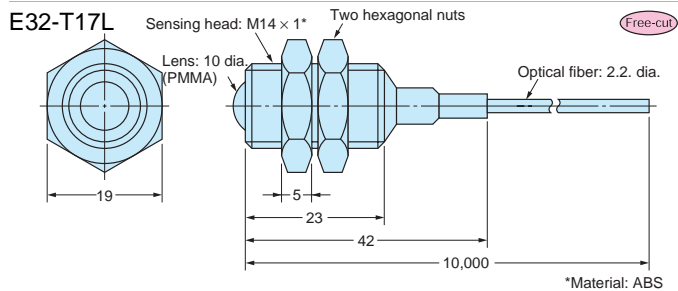

Ultracompact/Thin-sleeve Models

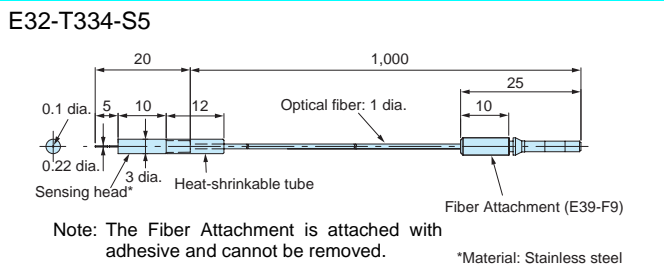
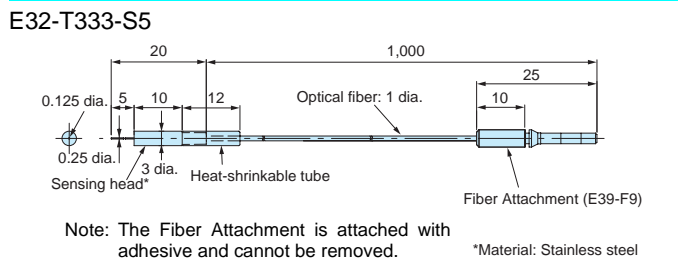
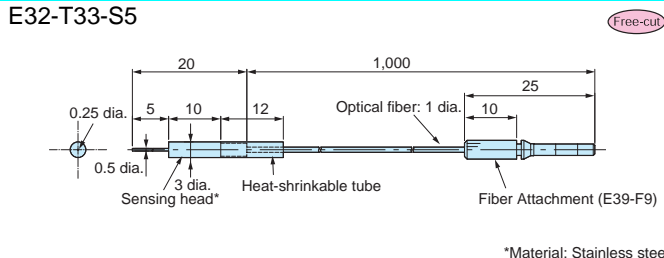
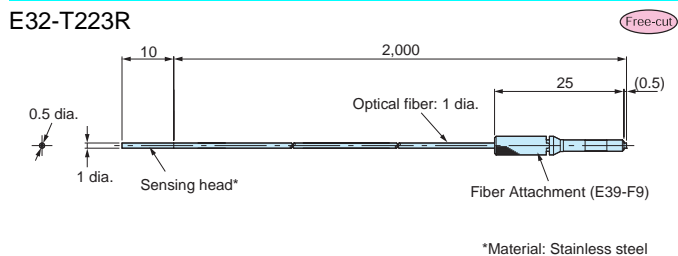

Through-beam Fiber Units

Fine-beam (narrow vision field) Models

E32-T22S

Free-cut

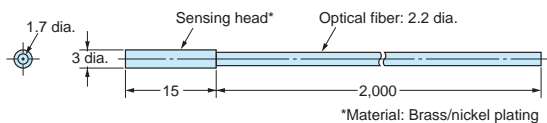

E32-T24S

Free-cut

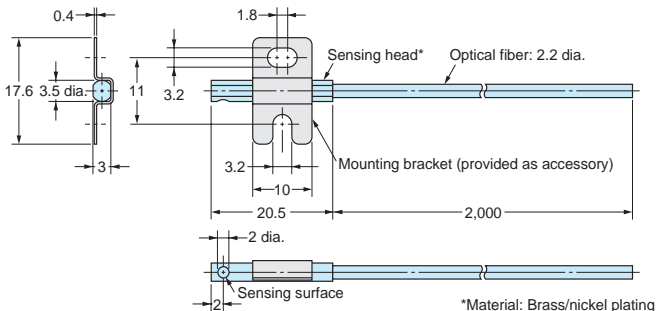

Area-sensing Models

E32-T16W
E32-T16WR

Free-cut

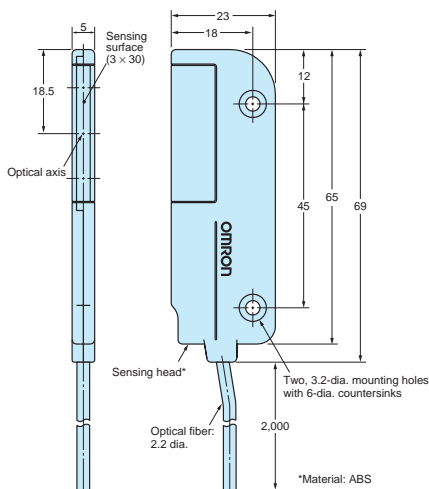

E32-M21

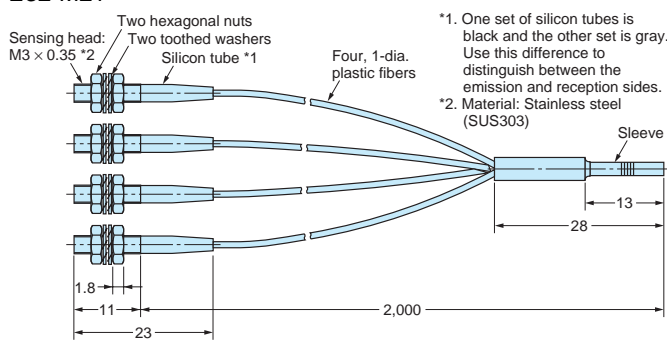

E32-T16P
E32-T16PR

Free-cut

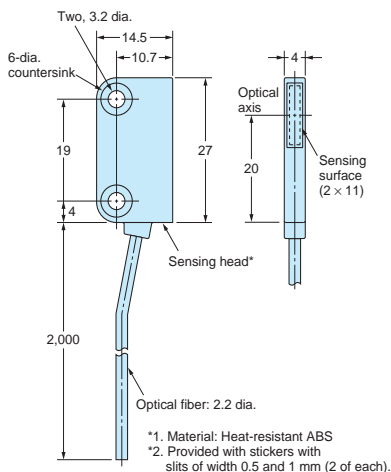

E32-T16J
E32-T16JR

Free-cut

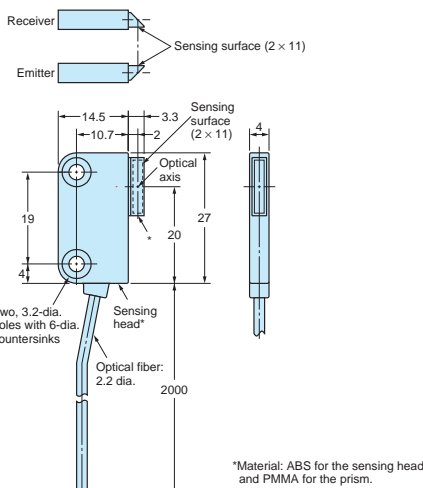

E32-T16

Free-cut

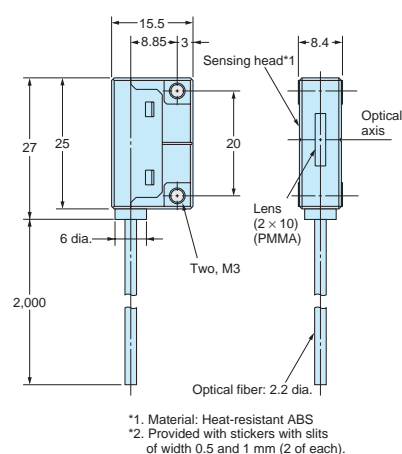

Heat-resistant Models

E32-T51

Free-cut

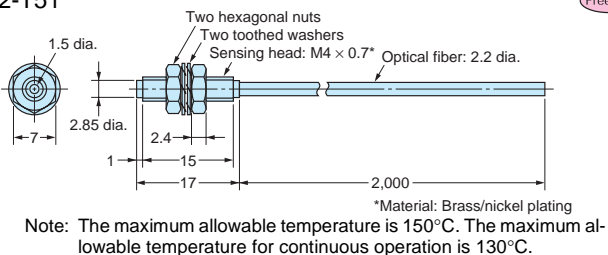

Note: The maximum allowable temperature is 150°C. The maximum allowable temperature for continuous operation is 130°C.

E32-T54

Free-cut

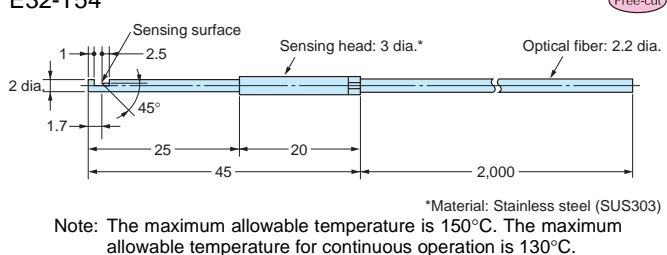

Note: The maximum allowable temperature is 150°C. The maximum allowable temperature for continuous operation is 130°C.

Through-beam Fiber Units

Heat-resistant Models

 Indicates models that allow free cutting.

E32-T81R-S

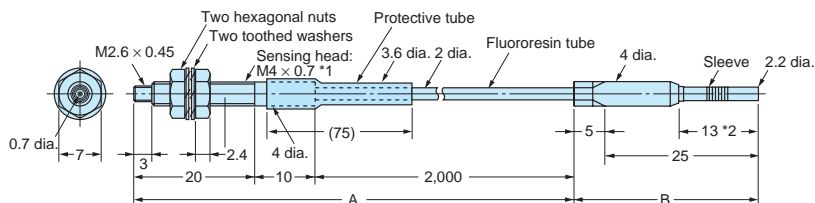

*1. Material: Stainless steel (SUS303)

Note: The maximum allowable temperatures for sections A and B are 200°C and 110°C, respectively. The section inserted into the Amplifier Unit (indicated by *2), however, must stay within the Amplifier Unit's operating temperature range.

E32-T84S-S

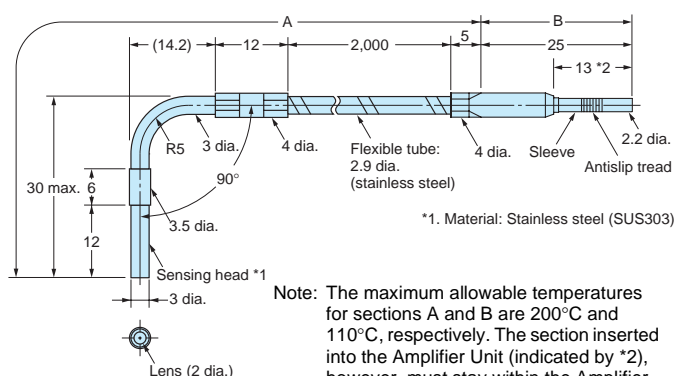

Note: The maximum allowable temperatures for sections A and B are 200°C and 110°C, respectively. The section inserted into the Amplifier Unit (indicated by *2), however, must stay within the Amplifier Unit's operating temperature range.

E32-T61-S

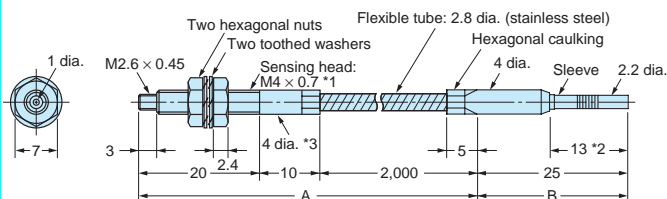

*1. Material: Stainless steel (SUS303)
*3. The diameter is 6 mm if the fiber length exceeds 10 m.

Note: The maximum allowable temperatures for sections A and B are 200°C and 110°C, respectively. The section inserted into the Amplifier Unit (indicated by *2), however, must stay within the Amplifier Unit's operating temperature range.

Chemical-resistant Models

E32-T11F



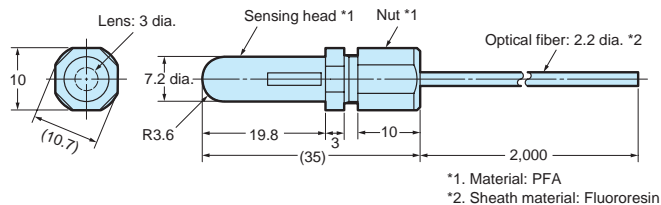

*1. Material: PFA
*2. Sheath material: Fluororesin

E32-T12F



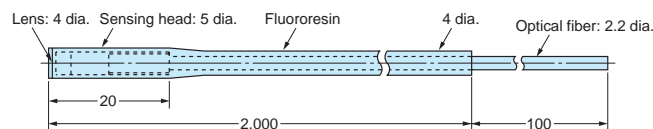

E32-T14F



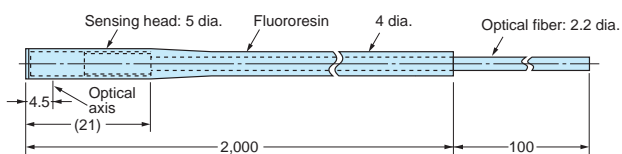

E32-T51F



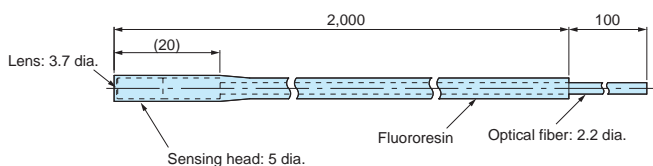

E32-T81F-S

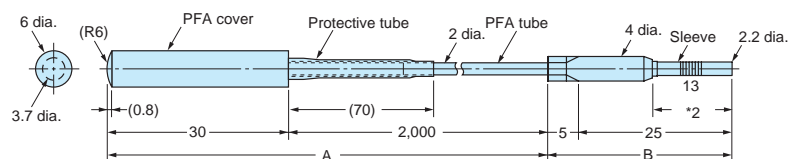

Note: The maximum allowable temperatures for sections A and B are 200°C and 110°C, respectively. The section inserted into the Amplifier Unit (indicated by *2), however, must stay within the Amplifier Unit's operating temperature range.

Through-beam Fiber Units
Vacuum-resistant Models

E32-T51V

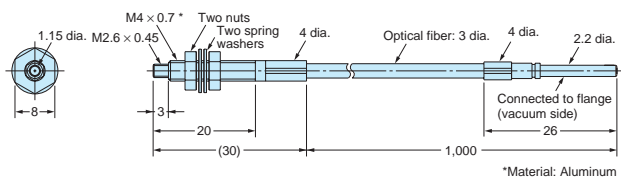

E32-T54V

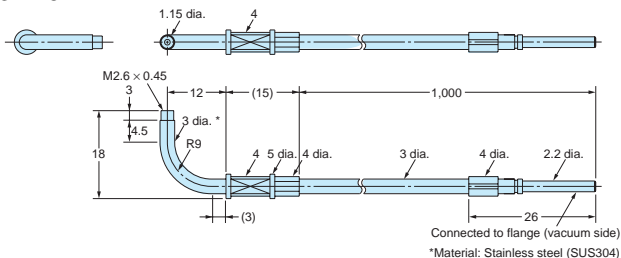

E32-T84SV

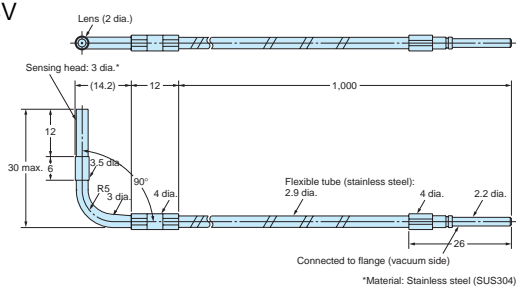

E39-F1V

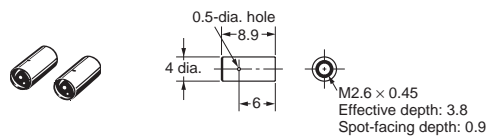

E32-VF4

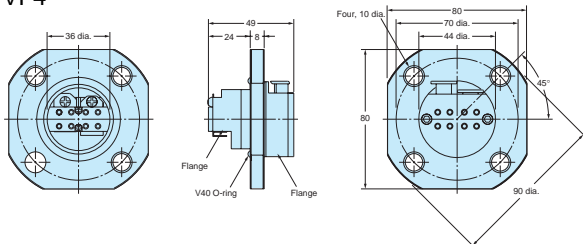

- Note 1. Perform mounting so that the V15 O-ring is on the atmospheric-pressure side of the vacuum chamber wall.
 2. Mounting-hole cutout dimensions: 14.5 dia. ± 0.2 mm

E32-VF1

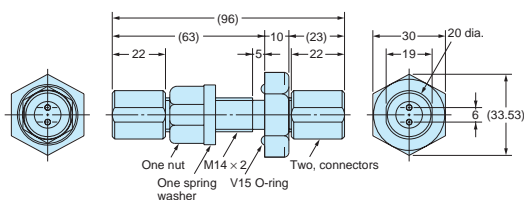

- Note 1. Perform mounting so that the V15 O-ring is on the atmospheric-pressure side of the vacuum chamber wall.
 2. Mounting-hole cutout dimensions: 14.5 dia. ± 0.2 mm

Dimensions

Fiber Units with Reflective Sensors

Standard/Flexible Models

(Free-cut) Indicates models that allow free cutting.

E32-DC200
E32-D11R

(Free-cut)

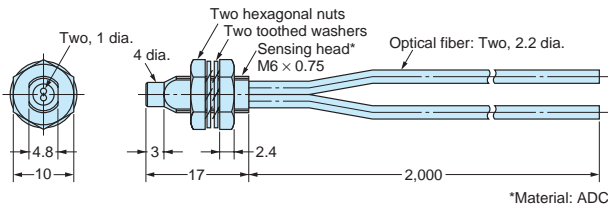

E32-D211
E32-D211R

(Free-cut)

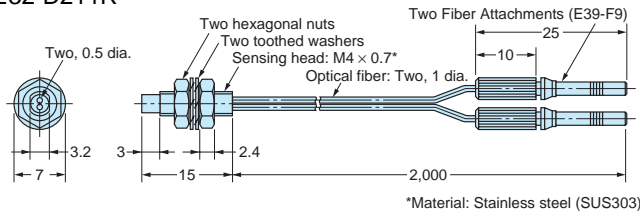

E32-DC200E
E32-D21R

(Free-cut)

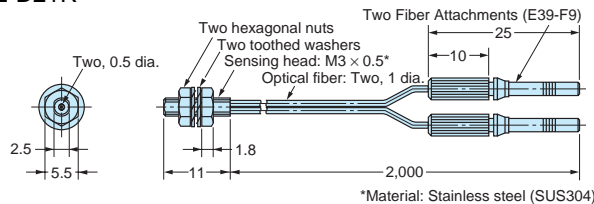

E32-D12
E32-D12R

(Free-cut)

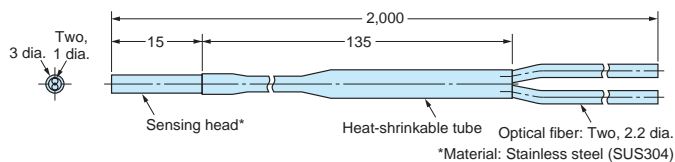

E32-D22
E32-D22R

(Free-cut)

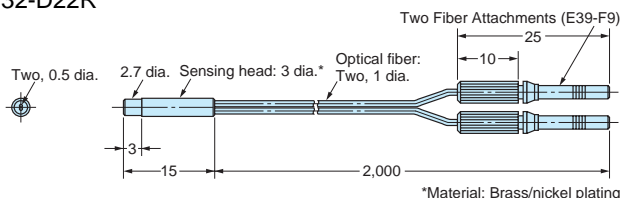

E32-D15X
E32-D15XR

(Free-cut)

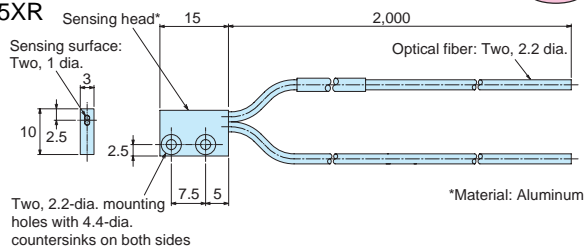

E32-D25X
E32-D25XR

(Free-cut)

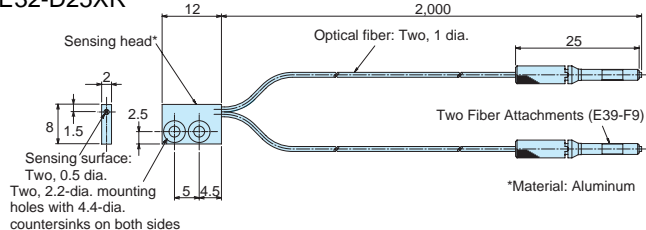

E32-DC200B(B4)
E32-DC200BR(B4R)

(Free-cut)

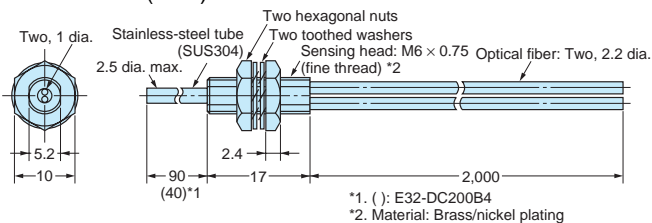

E32-DC200F(F4)
E32-DC200FR(F4R)

(Free-cut)

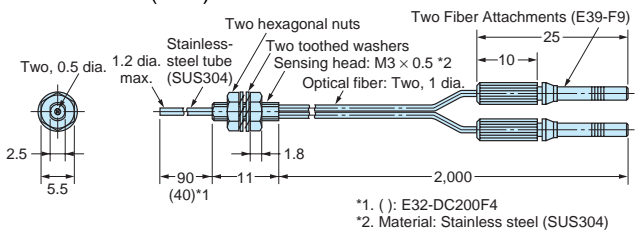

E32-D14L
E32-D14LR

(Free-cut)

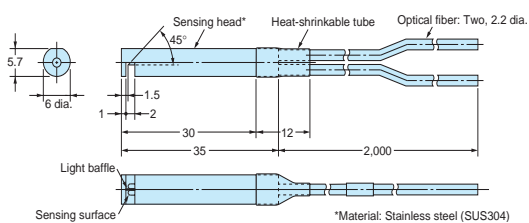

E32-D24
E32-D24R

(Free-cut)

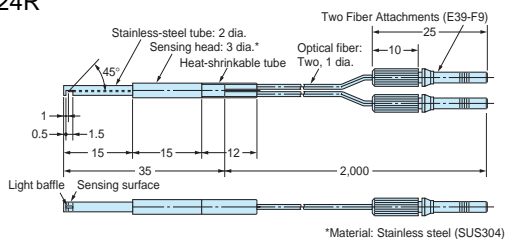

Fiber Units with Reflective Sensors

Standard/Flexible Models

E32-D15Y
E32-D15YR

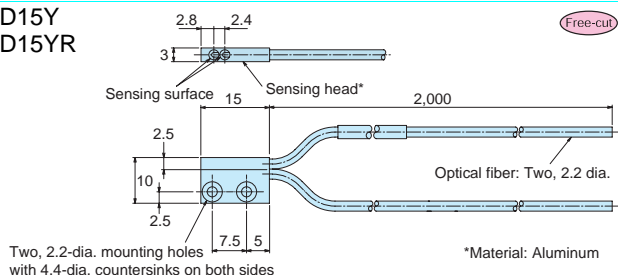

E32-D25Y
E32-D25YR

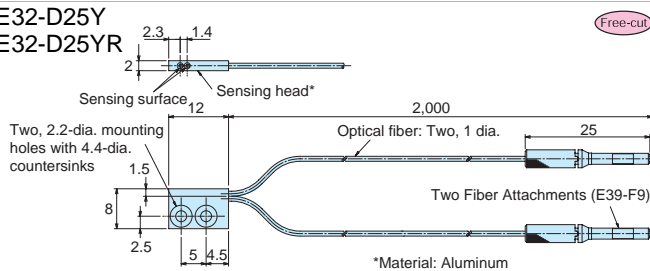

E32-D15Z
E32-D15ZR

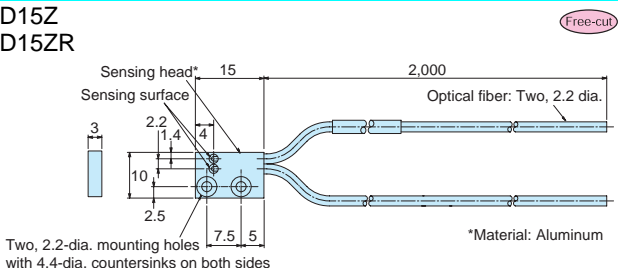

E32-D25Z
E32-D25ZR

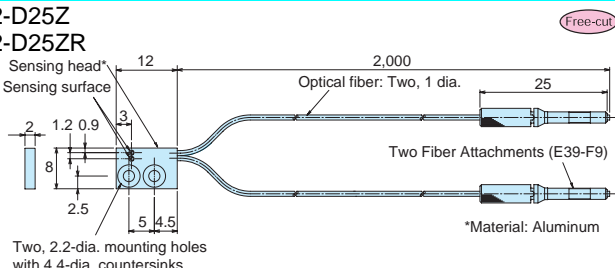

Break-resistant/Coated Models

E32-D11
E32-D11U

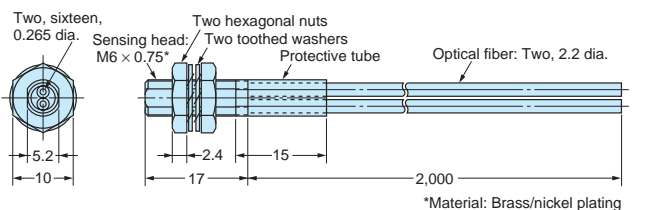

E32-D21B

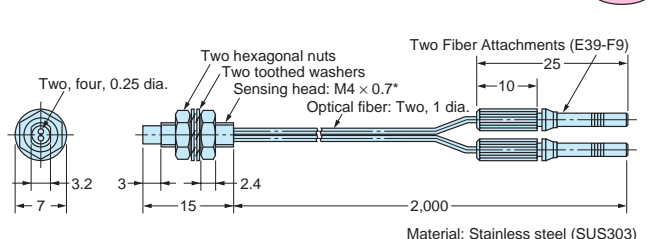

E32-D21

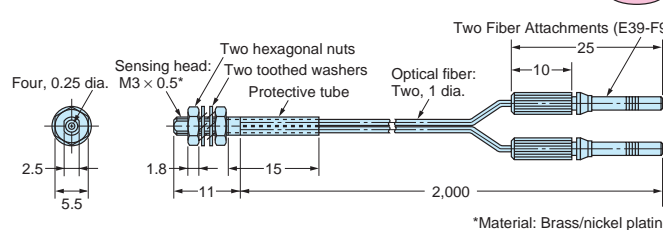

E32-D221B

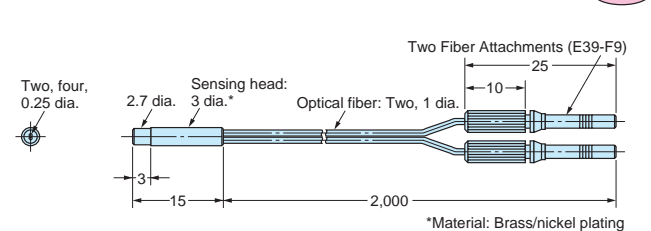

E32-D22B

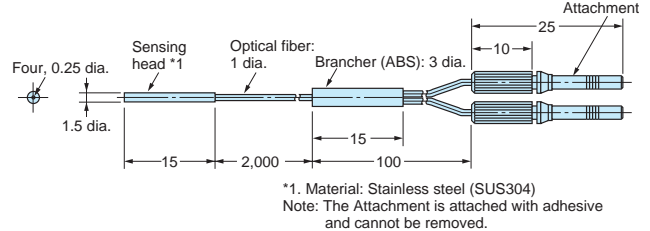

E32-D15XB

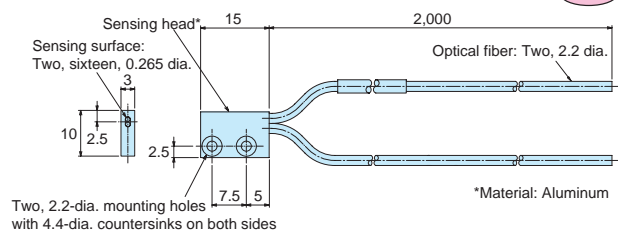

E32-D25XB

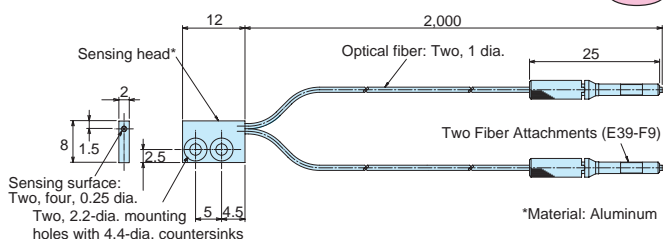

Fiber Units with Reflective Sensors

Long-distance/High-power Models

Free-cut Indicates models that allow free cutting.

E32-D16

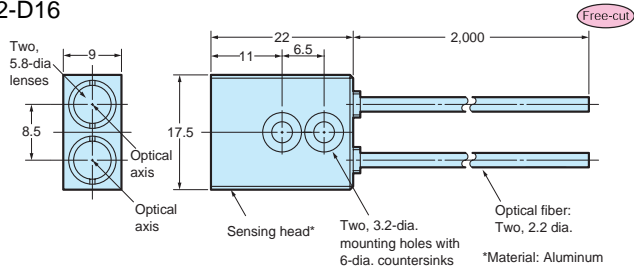

E32-D11L

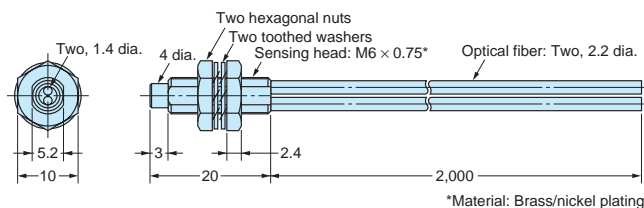

E32-D21L

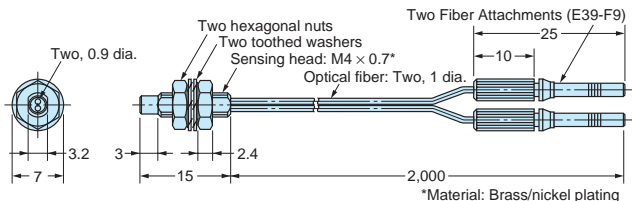

E32-D22L

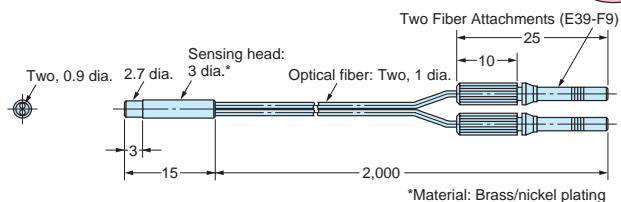

Ultracompact/Thin-sleeve Models

E32-D33

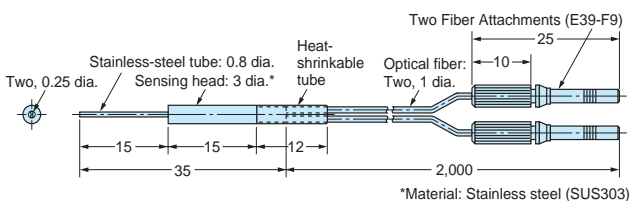

E32-D331

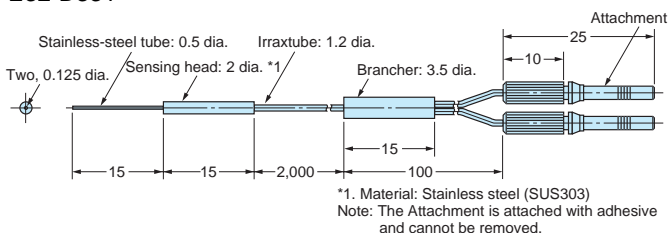

Coaxial/Small-spot Models

E32-CC200
E32-CC200R

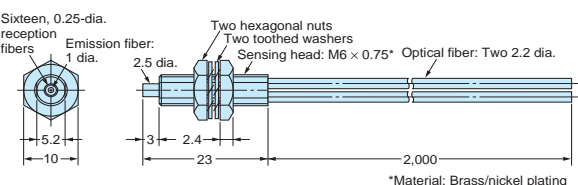

Note: There is a white line on the fiber that is inserted in the emitter-side port.

E32-D32L

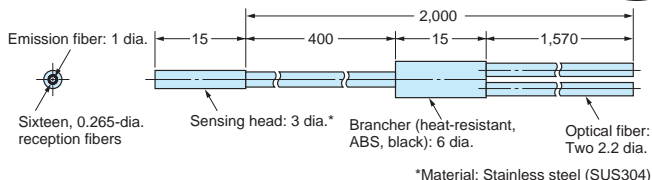

Note: There is a yellow dotted line on the fiber that is inserted in the emitter-side port.

E32-C31

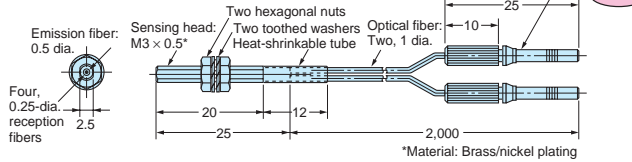

Note 1. There is a white line on the cable fiber that is inserted in the emitter-side port.
2. The core diameter of the sensing head is assumed to lie in the range 2.44 to 2.49 mm.

E32-D32

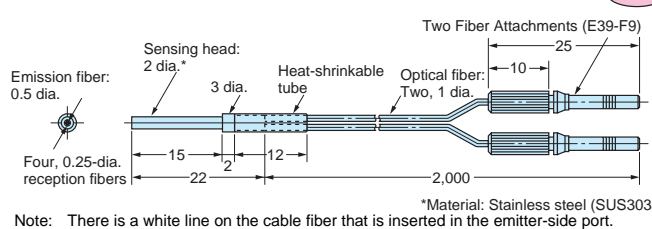

Note: There is a white line on the cable fiber that is inserted in the emitter-side port.

E32-C41

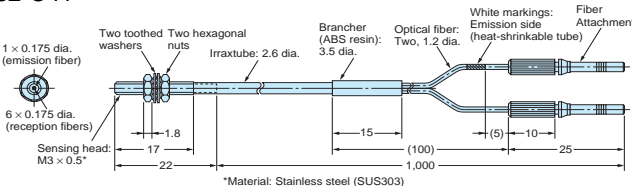

Note: The Fiber Attachment is attached with adhesive and cannot be removed.

E32-C42

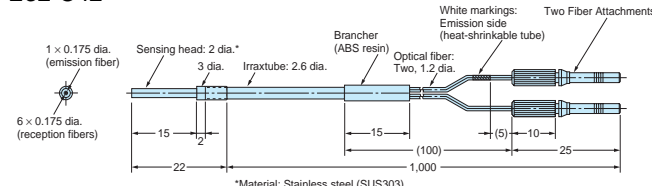

Note: The Fiber Attachment is attached with adhesive and cannot be removed.

Fiber Units with Reflective Sensors

Area-sensing Models

E32-D36P1

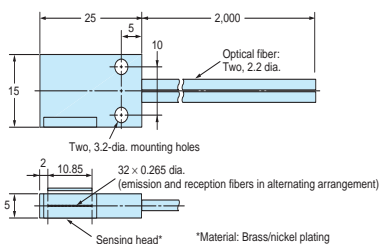

Free-cut

Retroreflective Fiber Units

E32-R21

(An E39-R3 Reflector is provided as an accessory.)

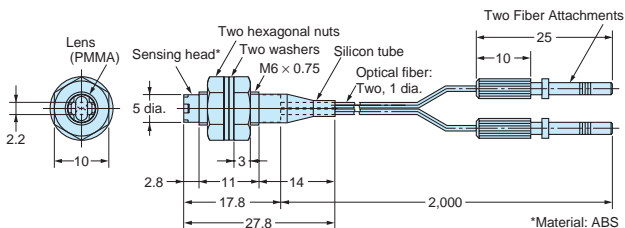

Free-cut

E32-R16

(An E39-R1 Reflector is provided as an accessory.)

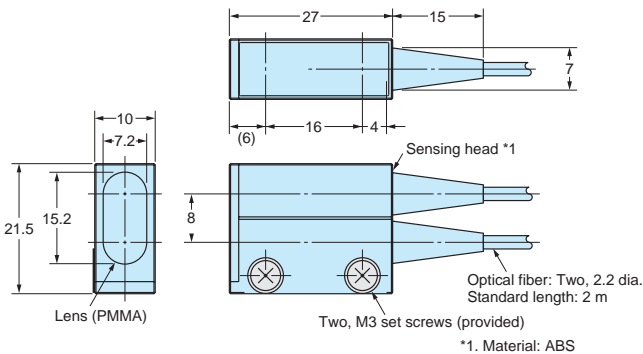

Free-cut

Limited-reflective Models

E32-L24S

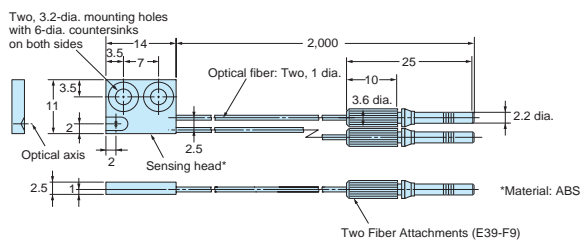

Free-cut

E32-L16

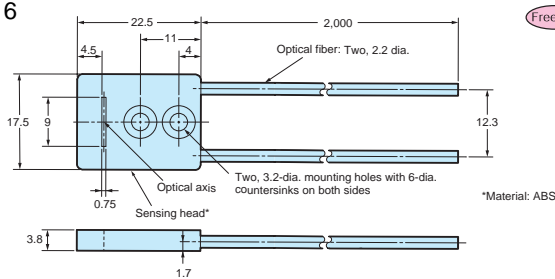

Free-cut

E32-L24L

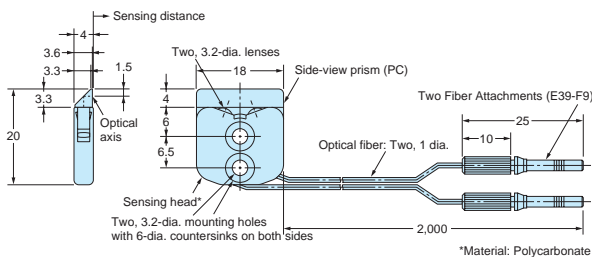

Free-cut

E32-L25L

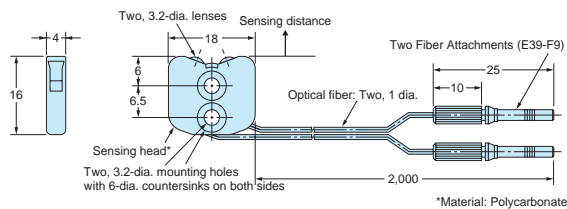

Free-cut

E32-L25

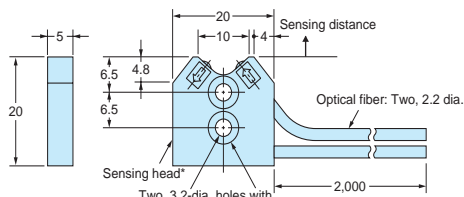

Free-cut

E32-L25A

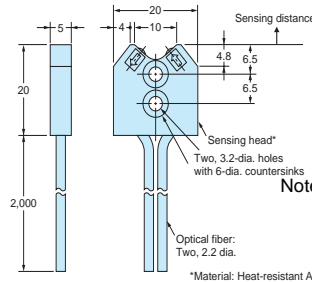

Free-cut

Note: There is a white line on the fiber that is inserted in the emitter-side port.

Note: There is a white line on the fiber that is inserted in the emitter-side port.

Fiber Units with Reflective Sensors

Limited-reflective Models

Free-cut Indicates models that allow free cutting.

E32-L86

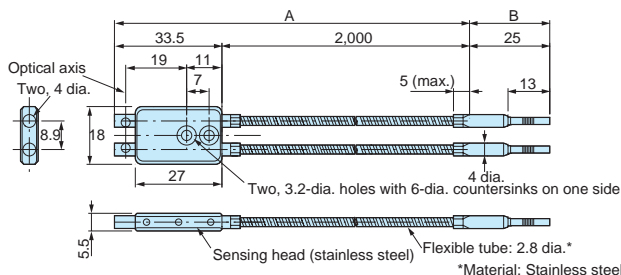

Note: The maximum allowable temperatures for sections A and B are 200°C and 110°C, respectively. The section inserted into the Amplifier Unit (indicated by *2), however, must stay within the Amplifier Unit's operating temperature range.

Heat-resistant Models

E32-D51

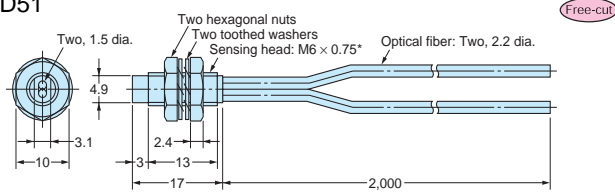

Note: The maximum allowable temperature is 150°C. The maximum allowable temperature for continuous operation is 130°C.

E32-D81R-S
E32-D81R

Using the E32-D81R-S

Using the E32-D81R

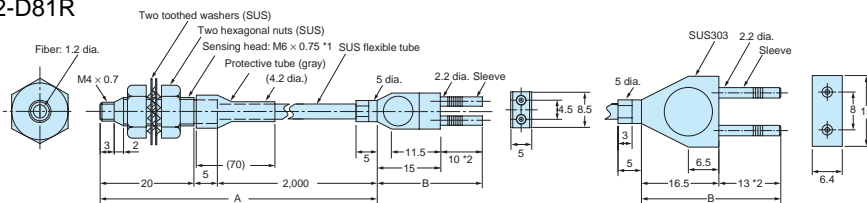

Note: The maximum allowable temperatures for sections A and B are 200°C and 110°C, respectively. The section inserted into the Amplifier Unit (indicated by *2), however, must stay within the Amplifier Unit's operating temperature range.

E32-D61-S
E32-D61

Using the E32-D61-S

Using the E32-D61

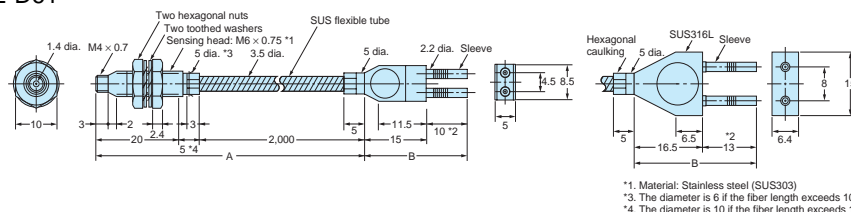

Note: The maximum allowable temperatures for sections A and B are 350°C and 110°C, respectively. The section inserted into the Amplifier Unit (indicated by *2), however, must stay within the Amplifier Unit's operating temperature range.

E32-D73-S
E32-D73

Using the E32-D73-S

Using the E32-D73

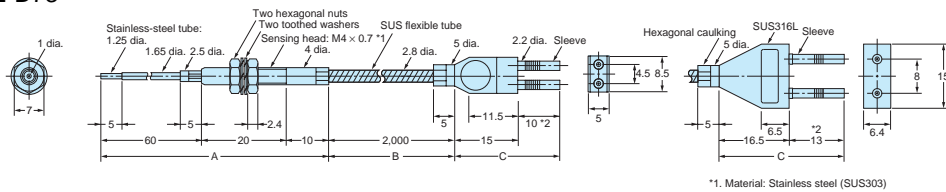

Note: The maximum allowable temperatures for sections A, B, and C are 400°C, 300°C, and 110°C, respectively. The section inserted into the Amplifier Unit (indicated by *2), however, must stay within the Amplifier Unit's operating temperature range.

Chemical-resistant Models

E32-D12F

Free-cut

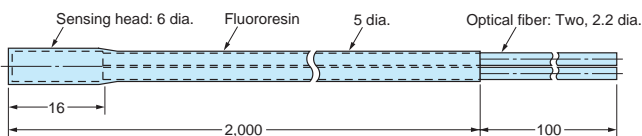

E32-D14F

Free-cut

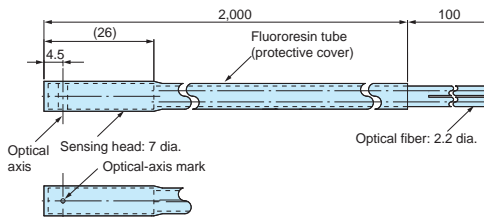

Dimensions

Application-specific Fiber Units

Label-detection Models

E32-G14

Free-cut

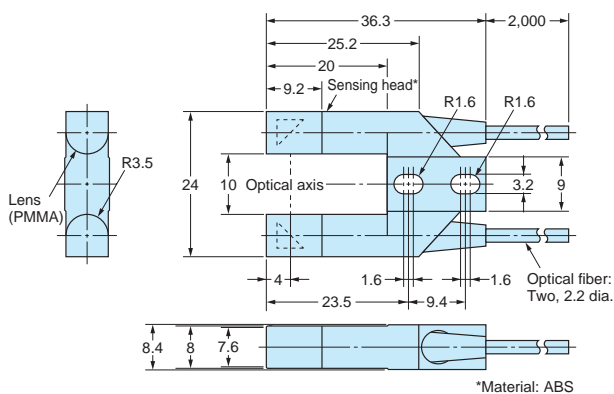

Liquid-level Detection Models

E32-D36T

Free-cut

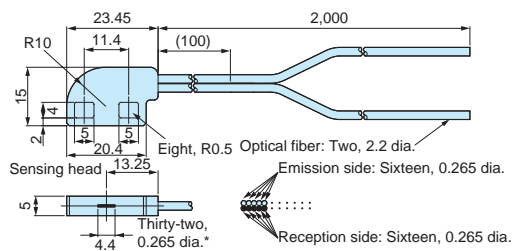

E32-L25T

Free-cut

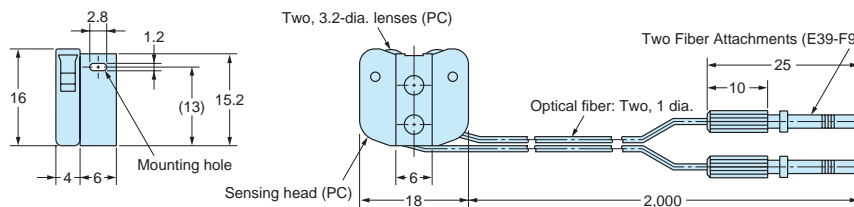

E32-A01

Free-cut

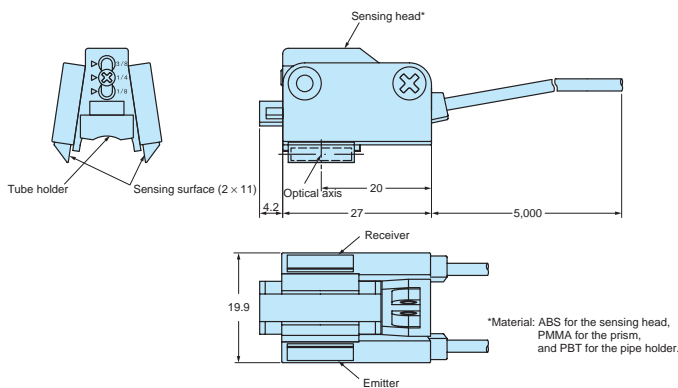

E32-A02

Free-cut

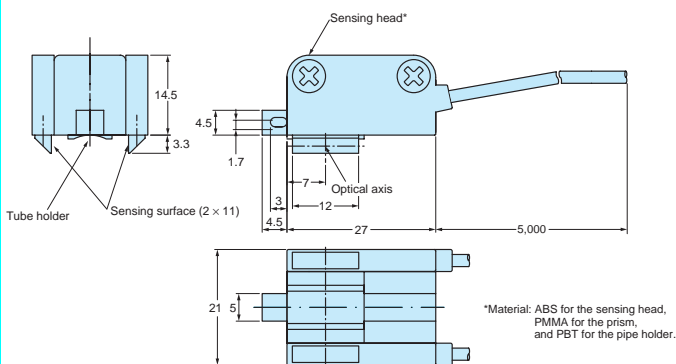

E32-D82F1

E32-D82F2

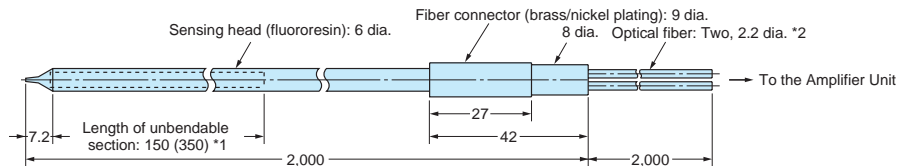

Accessories

Lens Units

Lens Units
E39-F1

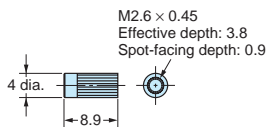

Material:
Brass for the body and optical glass for the lens itself.

Note: Two per set.

Side-view Units
E39-F2

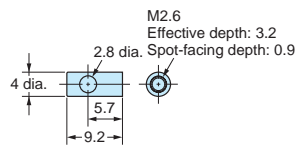

Material:
Brass for the body and optical glass for the lens itself.

Note: Two per set.

Reflection Unit with Lens
E39-F3

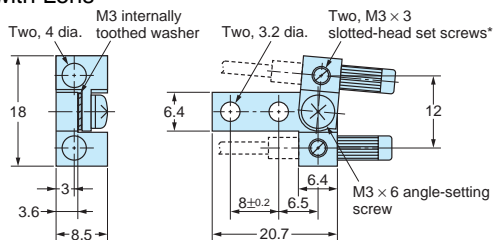

Material:
Brass for the body and aluminum for the base.

*Secure the fiber head with the slotted-head set screws. Do not insert a lens (E39-F1).

Lens Unit for Reflective Fiber Units
E39-F3A

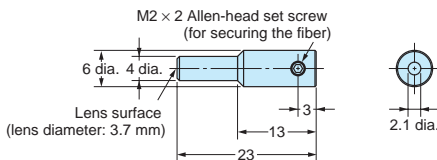

Material:
Aluminum for body and optical glass for lens.

Note: This is the Lens Unit for the E32-D32 and E32-C42.

Lens Unit for Reflective Fiber Units
E39-F3A-5

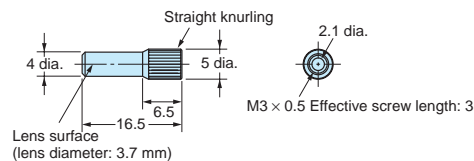

Material:
Aluminum for body and optical glass for lens

Note: This is the Lens Unit for the E32-C31 and E32-C41.

Lens Unit for Reflective Fiber Units
E39-F3B

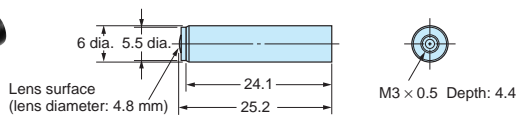

Material:
Aluminum for body and optical glass for lens.

Note: This is the Lens Unit for the E32-C31 and E32-C41.

Lens Unit for Reflective Fiber Units
E39-F3C

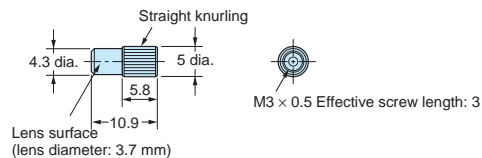

Material:
Aluminum for body and optical glass for lens.

Note: This is the Lens Unit for the E32-C31 and E32-C41.

Accessories

Protective Spiral Tubes

E39-F32A/F32A5
E39-F32B/F32B5

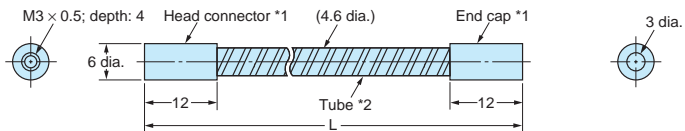

*1. Material: Brass/nickel plating
*2. Material: Stainless steel (SUS304)

Note 1. The length L is 1,000 for the E39-F32A/F32B and 500 for the E39-F32A5/F32B5.
2. The E39-F32B(5) consists of two E39-F32A(5)s.

E39-F32C/F32C5

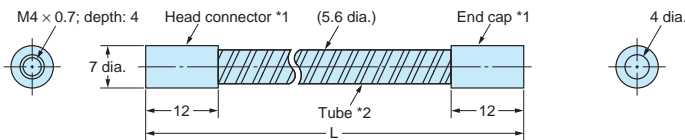

*1. Material: Brass/nickel plating
*2. Material: Stainless steel (SUS304)

Note: The length L is 1,000 for the E39-F32C and 500 for the E39-F32C5.

E39-F32D/F32D5

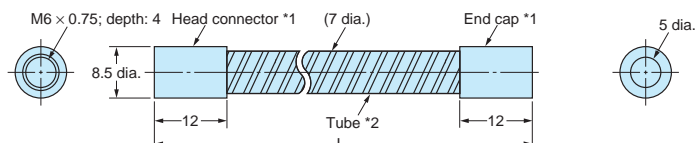

*1. Material: Brass/nickel plating
*2. Material: Stainless steel (SUS304)

Note: The length L is 1,000 for the E39-F32D and 500 for the E39-F32D5.

Other Accessories

Fiber Cutter
E39-F4

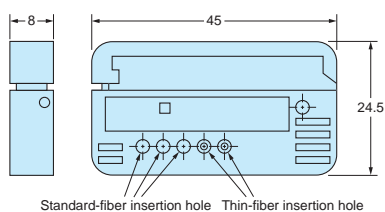

Thin-fiber Attachments
E39-F9

Material: ABS

Note: Two per set.
*Provided with thin-fiber models.

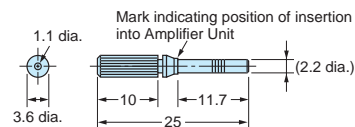

Fiber Connector
E39-F10

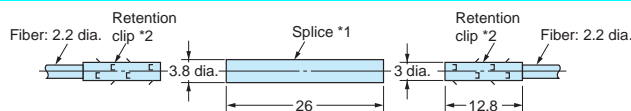

*1. Material: Polyester
*2. Material: Brass

Fiber Connector
E39-F13
E39-F14
E39-F15

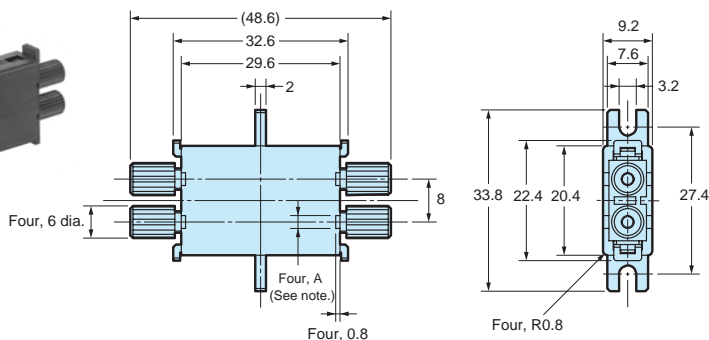

Note: Dimension A varies with the model number as shown in the following table.

Model	Dimension A
E39-F13	2.4
E39-F14	1.2
E39-F15	2.4/1.2

Sleeve Bender
E39-F11

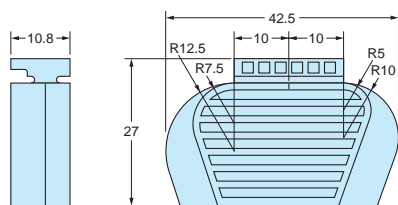

Precautions

Precautions for Correct Use

■ Fiber Units

Mounting

Tightening Force

The tightening force applied to the Fiber Unit should be as follows:

Screw-mounting Model

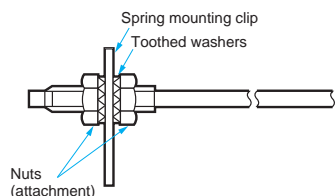

Cylindrical Model

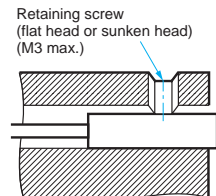

Fiber Units	Clamping torque
M6 screw/ 6-mm dia. cylinder	0.98 N·m max.
M3/M4 screw	0.78 N·m max.
2-mm dia./3-mm dia. cylinder	0.29 N·m max.
1.5-mm dia./1-mm dia. cylinder	0.2 N·m max.
E32-T12F 5-mm dia. fluororesin model	0.78 N·m max.
E32-D12F 6-mm dia. fluororesin model	
E32-L25A	
E32-M21	Up to 5 mm to the tip: 0.49 N·m max. More than 5 mm from the tip: 0.78 N·m max.
E32-T16	0.49 N·m max.
E32-R21	0.39 N·m max.
E32-T16W(R) E32-T16P(R) E32-T16J(R) E32-L24S E32-L24L E32-T25L	0.29 N·m max.

Use a proper-sized wrench.

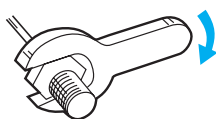

Fiber Cutting Procedure

Cut a thin fiber as follows:

①	An attachment is temporarily fitted to a thin fiber before shipment.	
②	Secure the attachment after adjusting the position of it in the direction indicated by the arrow.	
③	Insert the fiber to be cut into the E39-F4.	
④	Finished state (proper cutting state)	

Note: Insert the fiber in the direction indicated by the arrow.

Connection

- Do not pull or press the Fiber Units. The Fiber Units have a withstand force of 9.8 N or 29.4 N maximum.
- Do not bend the Fiber Unit beyond the permissible bending radius given under *Ordering Information*.
- Do not bend the edge of the Fiber Units (excluding the E32-T□R and E32-D□R).

Correct

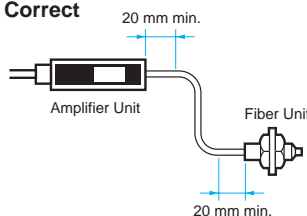

Incorrect

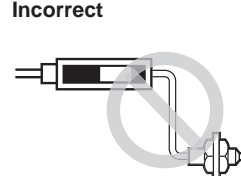

- Do not apply excess force on the Fiber Units.

Correct

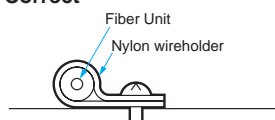

Incorrect

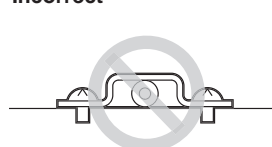

The Fiber Head could be broken by excessive vibration. To prevent this, the following is effective:

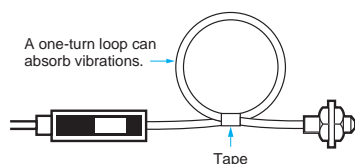

E39-F11 Sleeve Bender

- The bending radius of the stainless steel tube should be as large as possible. The smaller the bending radius becomes, the shorter the sensing distance will be.
- Insert the tip of the stainless steel tube to the Sleeve Bender and bend the stainless steel tube slowly along the curve of the Sleeve Bender (refer to the figure).

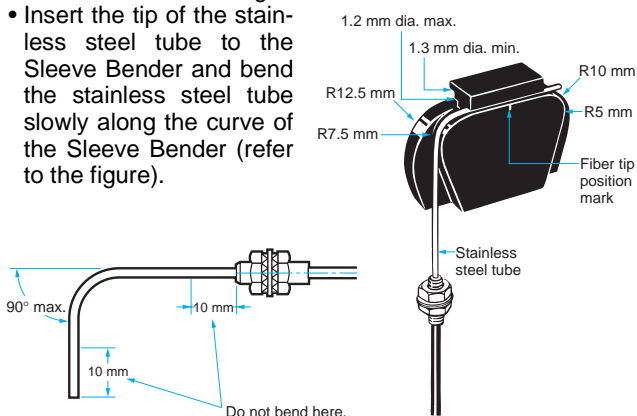

Heat-resistant Fiber Units (E32-D51 and E32-T51)

- The fibers of these Units cannot be extended using the E39-F10 Fiber Connector.
- The maximum allowable temperature for continuous operation with these Units is 130°C. It is 150°C for short-term use.

E32-T14 and E32-G14

These Units may enter the light-ON state if there are reflecting objects at the ends of the lenses. In this case, attach the black stickers provided to the ends of the lenses.

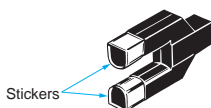

Wafer Sensors (E32-L25(A))

- To ensure correct performance, insert the fiber with a white line into the emitter-side port of the Amplifier Unit.

E32-T16 and E32-T16P

Example

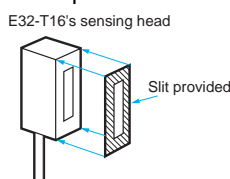

To use the slit provided, peel off the backing sheet, align it with the edges of the sensing surface, and attach it to the sensing head. Use the slit in applications where saturation occurs (i.e., changes in light intensity cannot be obtained) due to short sensing distances.

E32-M21

Separate the 4 fibers by distances sufficient to prevent interference.

Vacuum-resistant Fiber Units (E32-V)

Although Flanges, Fiber Units on the vacuum side, and Lens Units have been cleaned, as an extra precaution, clean these products with alcohol before use in high-vacuum environments to ensure that they are properly degreased.

Liquid-level Detection Sensors (E32-D82F)

- Secure the Fiber Unit using the unbendable section. Otherwise, the liquid-level detection position may be displaced.
- For applications in hazardous environments, install the Fiber Unit in the hazardous environment but install the Amplifier Unit in a safe environment.

Liquid-level Detection Sensors: Tube-mounting Models

- Ensure that the tube is not deformed when using a band to secure the Fiber Unit.
- Drops of water, bubbles, or haze inside the tube may cause malfunctions.

● **Adjustment**

E32-G14

The sensing distance is short, making the incident light intensity large. This makes it impossible to teach without a workpiece. Perform teaching with and without a workpiece.

Liquid-level (E32-D82F) Detection Position

The liquid-level detection position is at a distance of 5.2±2 mm from the end of the fluorescein section. (Refer to the diagram on the right.)

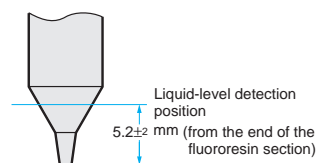

The liquid-level detection position varies with the surface tension of the liquid and the degree of wetness at the Fiber Unit's detection position.

● **Other Considerations**

Liquid Level (E32-D82F)

- Operation may become unstable in the following cases:
 - ① Bubbles stick to the cone of the sensing head.
 - ② Solute is deposited on the cone of the sensing head.
 - ③ The liquid has a high viscosity.
- There are some liquids, such as milky white liquids, for which detection is not possible.
- Do not let the end of the fluorescein section bump into another object. Damage to, or deformation of, the sensing head may result in unstable operation.

Heat-resistant Fiber Units (E32-D81R, E32-D61, and E32-D73)

The pitch of the emission-side and reception-side fiber-insertion ports varies with the Amplifier Unit. Be sure to use an appropriate Fiber Unit.

Amplifier Unit	Fiber Unit
E3X-DA□-S E3X-MDA□	E32-D□-S
E3X-DA□-N E3X-NA□	E32-D□

■ Accessories

Use of E39-R3 Reflector

1. Use detergent, etc., to remove any dust or oil from the surfaces where tape is applied. Adhesive tape will not be attached properly if oil or dust remains on the surface.
2. The E39-R3 cannot be used in places where it is exposed to oil or chemicals.

E39-F32□ Protective Spiral Tubes

1. Insert a fiber to the Protective Spiral Tube from the head connector side (screwed) of the tube.

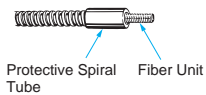

2. Push the fiber into the Protective Spiral Tube. The tube should be straight so that the fiber is not twisted when inserted. Then turn the end cap of the spiral tube.

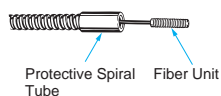

3. Secure the Protective Spiral Tube on a suitable place with the attached nut.

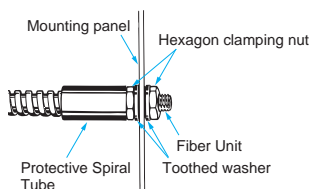

4. Use the attached saddle to secure the end cap of the Protective Spiral Tube. To secure the Protective Spiral Tube at a position other than the end cap, apply tape to the tube so that the portion becomes thicker in diameter.

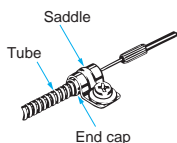

E39-F10 Fiber Connector

Mount the Fiber Connector as shown in the following illustrations.

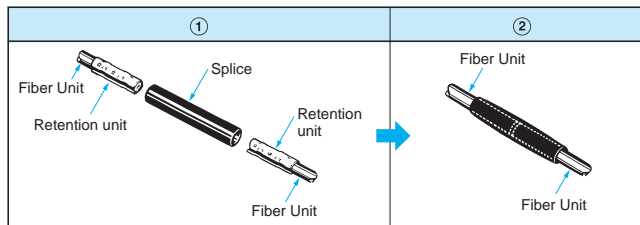

- The Fiber Units should be as close as possible when they are connected. Sensing distance will be reduced by approximately 25% when fibers are connected.
- Only 2.2-mm dia. fibers can be connected.

MEMO

A large grid of dashed lines for taking notes, consisting of 20 columns and 25 rows of squares.

READ AND UNDERSTAND THIS DOCUMENT

Please read and understand this document before using the products. Please consult your OMRON representative if you have any questions or comments.

WARRANTY

OMRON's exclusive warranty is that the products are free from defects in materials and workmanship for a period of one year (or other period if specified) from date of sale by OMRON.

OMRON MAKES NO WARRANTY OR REPRESENTATION, EXPRESS OR IMPLIED, REGARDING NON-INFRINGEMENT, MERCHANTABILITY, OR FITNESS FOR PARTICULAR PURPOSE OF THE PRODUCTS. ANY BUYER OR USER ACKNOWLEDGES THAT THE BUYER OR USER ALONE HAS DETERMINED THAT THE PRODUCTS WILL SUITABLY MEET THE REQUIREMENTS OF THEIR INTENDED USE. OMRON DISCLAIMS ALL OTHER WARRANTIES, EXPRESS OR IMPLIED.

LIMITATIONS OF LIABILITY

OMRON SHALL NOT BE RESPONSIBLE FOR SPECIAL, INDIRECT, OR CONSEQUENTIAL DAMAGES, LOSS OF PROFITS OR COMMERCIAL LOSS IN ANY WAY CONNECTED WITH THE PRODUCTS, WHETHER SUCH CLAIM IS BASED ON CONTRACT, WARRANTY, NEGLIGENCE, OR STRICT LIABILITY.

In no event shall responsibility of OMRON for any act exceed the individual price of the product on which liability is asserted.

IN NO EVENT SHALL OMRON BE RESPONSIBLE FOR WARRANTY, REPAIR, OR OTHER CLAIMS REGARDING THE PRODUCTS UNLESS OMRON'S ANALYSIS CONFIRMS THAT THE PRODUCTS WERE PROPERLY HANDLED, STORED, INSTALLED, AND MAINTAINED AND NOT SUBJECT TO CONTAMINATION, ABUSE, MISUSE, OR INAPPROPRIATE MODIFICATION OR REPAIR.

SUITABILITY FOR USE

THE PRODUCTS CONTAINED IN THIS DOCUMENT ARE NOT SAFETY RATED. THEY ARE NOT DESIGNED OR RATED FOR ENSURING SAFETY OF PERSONS, AND SHOULD NOT BE RELIED UPON AS A SAFETY COMPONENT OR PROTECTIVE DEVICE FOR SUCH PURPOSES. Please refer to separate catalogs for OMRON's safety rated products.

OMRON shall not be responsible for conformity with any standards, codes, or regulations that apply to the combination of products in the customer's application or use of the product.

At the customer's request, OMRON will provide applicable third party certification documents identifying ratings and limitations of use that apply to the products. This information by itself is not sufficient for a complete determination of the suitability of the products in combination with the end product, machine, system, or other application or use.

The following are some examples of applications for which particular attention must be given. This is not intended to be an exhaustive list of all possible uses of the products, nor is it intended to imply that the uses listed may be suitable for the products:

- Outdoor use, uses involving potential chemical contamination or electrical interference, or conditions or uses not described in this document.
- Nuclear energy control systems, combustion systems, railroad systems, aviation systems, medical equipment, amusement machines, vehicles, safety equipment, and installations subject to separate industry or government regulations.
- Systems, machines, and equipment that could present a risk to life or property.

Please know and observe all prohibitions of use applicable to the products.

NEVER USE THE PRODUCTS FOR AN APPLICATION INVOLVING SERIOUS RISK TO LIFE OR PROPERTY WITHOUT ENSURING THAT THE SYSTEM AS A WHOLE HAS BEEN DESIGNED TO ADDRESS THE RISKS, AND THAT THE OMRON PRODUCT IS PROPERLY RATED AND INSTALLED FOR THE INTENDED USE WITHIN THE OVERALL EQUIPMENT OR SYSTEM.

PERFORMANCE DATA

Performance data given in this document is provided as a guide for the user in determining suitability and does not constitute a warranty. It may represent the result of OMRON's test conditions, and the users must correlate it to actual application requirements. Actual performance is subject to the OMRON Warranty and Limitations of Liability.

CHANGE IN SPECIFICATIONS

Product specifications and accessories may be changed at any time based on improvements and other reasons.

It is our practice to change model numbers when published ratings or features are changed, or when significant construction changes are made. However, some specifications of the product may be changed without any notice. When in doubt, special model numbers may be assigned to fix or establish key specifications for your application on your request. Please consult with your OMRON representative at any time to confirm actual specifications of purchased products.

DIMENSIONS AND WEIGHTS

Dimensions and weights are nominal and are not to be used for manufacturing purposes, even when tolerances are shown.

ERRORS AND OMISSIONS

The information in this document has been carefully checked and is believed to be accurate; however, no responsibility is assumed for clerical, typographical, or proofreading errors, or omissions.

PROGRAMMABLE PRODUCTS

OMRON shall not be responsible for the user's programming of a programmable product, or any consequence thereof.

COPYRIGHT AND COPY PERMISSION

This document shall not be copied for sales or promotions without permission.

This document is protected by copyright and is intended solely for use in conjunction with the product. Please notify us before copying or reproducing this document in any manner, for any other purpose. If copying or transmitting this document to another, please copy or transmit it in its entirety.

**A host of remarkable functions inside a compact body.
 A complete lineup of sensor heads to
 handle an even wider range of applications.
 This is the platform for OMRON's sensing technology.**

Linear Platform

High-resolution sensing using laser and magnetic technology.

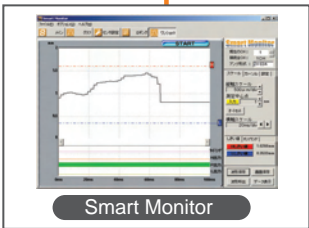

**Laser-type Smart Sensors
 ZX-L Series**



An improved lineup for smarter sensing.

**Inductive Displacement
 Smart Sensors
 ZX-E Series**



A lineup of Smart Sensors that use the eddy current method.

ON/OFF Platform

A common platform for Fiber Sensors and Sensors with Separate Amplifiers.



**Digital Fiber Sensors
 E3X-DA-S Series/MDA Series**



Refinement and a new generation that goes beyond superior performance.

**Laser-type Photoelectric Sensors
 with Separate Digital Amplifiers
 E3C-LDA Series**



Photoelectric Sensors with Separate Digital Amplifiers have joined the Smart Sensor family.

This document provides information mainly for selecting suitable models. Please read the Instruction Sheet carefully for information that the user must understand and accept before purchase, including information on warranty, limitations of liability, and precautions.

Note: Do not use this document to operate the Unit.

Terms and Conditions of Sale

1. **Offer; Acceptance.** These terms and conditions (these "Terms") are deemed part of all quotes, agreements, purchase orders, acknowledgments, price lists, catalogs, manuals, brochures and other documents, whether electronic or in writing, relating to the sale of products or services (collectively, the "Products") by Omron Electronics LLC and its subsidiary companies ("Omron"). Omron objects to any terms or conditions proposed in Buyer's purchase order or other documents which are inconsistent with, or in addition to, these Terms.
2. **Prices; Payment Terms.** All prices stated are current, subject to change without notice by Omron. Omron reserves the right to increase or decrease prices on any unshipped portions of outstanding orders. Payments for Products are due net 30 days unless otherwise stated in the invoice.
3. **Discounts.** Cash discounts, if any, will apply only on the net amount of invoices sent to Buyer after deducting transportation charges, taxes and duties, and will be allowed only if (i) the invoice is paid according to Omron's payment terms and (ii) Buyer has no past due amounts.
4. **Interest.** Omron, at its option, may charge Buyer 1-1/2% interest per month or the maximum legal rate, whichever is less, on any balance not paid within the stated terms.
5. **Orders.** Omron will accept no order less than \$200 net billing.
6. **Governmental Approvals.** Buyer shall be responsible for, and shall bear all costs involved in, obtaining any government approvals required for the importation or sale of the Products.
7. **Taxes.** All taxes, duties and other governmental charges (other than general real property and income taxes), including any interest or penalties thereon, imposed directly or indirectly on Omron or required to be collected directly or indirectly by Omron for the manufacture, production, sale, delivery, importation, consumption or use of the Products sold hereunder (including customs duties and sales, excise, use, turnover and license taxes) shall be charged to and remitted by Buyer to Omron.
8. **Financial.** If the financial position of Buyer at any time becomes unsatisfactory to Omron, Omron reserves the right to stop shipments or require satisfactory security or payment in advance. If Buyer fails to make payment or otherwise comply with these Terms or any related agreement, Omron may (without liability and in addition to other remedies) cancel any unshipped portion of Products sold hereunder and stop any Products in transit until Buyer pays all amounts, including amounts payable hereunder, whether or not then due, which are owing to it by Buyer. Buyer shall in any event remain liable for all unpaid accounts.
9. **Cancellation; Etc.** Orders are not subject to rescheduling or cancellation unless Buyer indemnifies Omron against all related costs or expenses.
10. **Force Majeure.** Omron shall not be liable for any delay or failure in delivery resulting from causes beyond its control, including earthquakes, fires, floods, strikes or other labor disputes, shortage of labor or materials, accidents to machinery, acts of sabotage, riots, delay in or lack of transportation or the requirements of any government authority.
11. **Shipping; Delivery.** Unless otherwise expressly agreed in writing by Omron:
 - a. Shipments shall be by a carrier selected by Omron; Omron will not drop ship except in "break down" situations.
 - b. Such carrier shall act as the agent of Buyer and delivery to such carrier shall constitute delivery to Buyer;
 - c. All sales and shipments of Products shall be FOB shipping point (unless otherwise stated in writing by Omron), at which point title and risk of loss shall pass from Omron to Buyer; provided that Omron shall retain a security interest in the Products until the full purchase price is paid;
 - d. Delivery and shipping dates are estimates only; and
 - e. Omron will package Products as it deems proper for protection against normal handling and extra charges apply to special conditions.
12. **Claims.** Any claim by Buyer against Omron for shortage or damage to the Products occurring before delivery to the carrier must be presented in writing to Omron within 30 days of receipt of shipment and include the original transportation bill signed by the carrier noting that the carrier received the Products from Omron in the condition claimed.
13. **Warranties.** (a) **Exclusive Warranty.** Omron's exclusive warranty is that the Products will be free from defects in materials and workmanship for a period of twelve months from the date of sale by Omron (or such other period expressed in writing by Omron). Omron disclaims all other warranties, express or implied. (b) **Limitations.** OMRON MAKES NO WARRANTY OR REPRESENTATION, EXPRESS OR IMPLIED, ABOUT NON-INFRINGEMENT, MERCHANTABILITY OR FITNESS FOR A PARTICULAR PURPOSE OF THE PRODUCTS. BUYER ACKNOWLEDGES THAT IT ALONE HAS DETERMINED THAT THE PRODUCTS WILL SUITABLY MEET THE REQUIREMENTS OF THEIR INTENDED USE. Omron further disclaims all warranties and responsibility of any type for claims or expenses based on infringement by the Products or otherwise of any intellectual property right. (c) **Buyer Remedy.** Omron's sole obligation hereunder shall be, at Omron's election, to (i) replace (in the form originally shipped with Buyer responsible for labor charges for removal or replacement thereof) the non-complying Product, (ii) repair the non-complying Product, or (iii) repay or credit Buyer an amount equal to the purchase price of the non-complying Product; provided that in no event shall Omron be responsible for warranty, repair, indemnity or any other claims or expenses regarding the Products unless Omron's analysis confirms that the Products were properly handled, stored, installed and maintained and not subject to contamination, abuse, misuse or inappropriate modification. Return of any Products by Buyer must be approved in writing by Omron before shipment. Omron Companies shall not be liable for the suitability or unsuitability or the results from the use of Products in combination with any electrical or electronic components, circuits, system assemblies or any other materials or substances or environments. Any advice, recommendations or information given orally or in writing, are not to be construed as an amendment or addition to the above warranty. See <http://www.omron247.com> or contact your Omron representative for published information.
14. **Limitation on Liability; Etc.** OMRON COMPANIES SHALL NOT BE LIABLE FOR SPECIAL, INDIRECT, INCIDENTAL, OR CONSEQUENTIAL DAMAGES, LOSS OF PROFITS OR PRODUCTION OR COMMERCIAL LOSS IN ANY WAY CONNECTED WITH THE PRODUCTS, WHETHER SUCH CLAIM IS BASED IN CONTRACT, WARRANTY, NEGLIGENCE OR STRICT LIABILITY. Further, in no event shall liability of Omron Companies exceed the individual price of the Product on which liability is asserted.
15. **Indemnities.** Buyer shall indemnify and hold harmless Omron Companies and their employees from and against all liabilities, losses, claims, costs and expenses (including attorney's fees and expenses) related to any claim, investigation, litigation or proceeding (whether or not Omron is a party) which arises or is alleged to arise from Buyer's acts or omissions under these Terms or in any way with respect to the Products. Without limiting the foregoing, Buyer (at its own expense) shall indemnify and hold harmless Omron and defend or settle any action brought against such Companies to the extent based on a claim that any Product made to Buyer specifications infringed intellectual property rights of another party.
16. **Property; Confidentiality.** Any intellectual property in the Products is the exclusive property of Omron Companies and Buyer shall not attempt to duplicate it in any way without the written permission of Omron. Notwithstanding any charges to Buyer for engineering or tooling, all engineering and tooling shall remain the exclusive property of Omron. All information and materials supplied by Omron to Buyer relating to the Products are confidential and proprietary, and Buyer shall limit distribution thereof to its trusted employees and strictly prevent disclosure to any third party.
17. **Export Controls.** Buyer shall comply with all applicable laws, regulations and licenses regarding (i) export of products or information; (ii) sale of products to "forbidden" or other proscribed persons; and (iii) disclosure to non-citizens of regulated technology or information.
18. **Miscellaneous.** (a) **Waiver.** No failure or delay by Omron in exercising any right and no course of dealing between Buyer and Omron shall operate as a waiver of rights by Omron. (b) **Assignment.** Buyer may not assign its rights hereunder without Omron's written consent. (c) **Law.** These Terms are governed by the law of the jurisdiction of the home office of the Omron company from which Buyer is purchasing the Products (without regard to conflict of law principles). (d) **Amendment.** These Terms constitute the entire agreement between Buyer and Omron relating to the Products, and no provision may be changed or waived unless in writing signed by the parties. (e) **Severability.** If any provision hereof is rendered ineffective or invalid, such provision shall not invalidate any other provision. (f) **Setoff.** Buyer shall have no right to set off any amounts against the amount owing in respect of this invoice. (g) **Definitions.** As used herein, "including" means "including without limitation"; and "Omron Companies" (or similar words) mean Omron Corporation and any direct or indirect subsidiary or affiliate thereof.

Certain Precautions on Specifications and Use

1. **Suitability of Use.** Omron Companies shall not be responsible for conformity with any standards, codes or regulations which apply to the combination of the Product in the Buyer's application or use of the Product. At Buyer's request, Omron will provide applicable third party certification documents identifying ratings and limitations of use which apply to the Product. This information by itself is not sufficient for a complete determination of the suitability of the Product in combination with the end product, machine, system, or other application or use. Buyer shall be solely responsible for determining appropriateness of the particular Product with respect to Buyer's application, product or system. Buyer shall take application responsibility in all cases but the following is a non-exhaustive list of applications for which particular attention must be given:
 - (i) Outdoor use, uses involving potential chemical contamination or electrical interference, or conditions or uses not described in this document.
 - (ii) Use in consumer products or any use in significant quantities.
 - (iii) Energy control systems, combustion systems, railroad systems, aviation systems, medical equipment, amusement machines, vehicles, safety equipment, and installations subject to separate industry or government regulations.
 - (iv) Systems, machines and equipment that could present a risk to life or property. Please know and observe all prohibitions of use applicable to this Product.
 NEVER USE THE PRODUCT FOR AN APPLICATION INVOLVING SERIOUS RISK TO LIFE OR PROPERTY OR IN LARGE QUANTITIES WITHOUT ENSURING THAT THE SYSTEM AS A WHOLE HAS BEEN DESIGNED TO ADDRESS THE RISKS, AND THAT THE OMRON'S PRODUCT IS PROPERLY RATED AND INSTALLED FOR THE INTENDED USE WITHIN THE OVERALL EQUIPMENT OR SYSTEM.
2. **Programmable Products.** Omron Companies shall not be responsible for the user's programming of a programmable Product, or any consequence thereof.
3. **Performance Data.** Data presented in Omron Company websites, catalogs and other materials is provided as a guide for the user in determining suitability and does not constitute a warranty. It may represent the result of Omron's test conditions, and the user must correlate it to actual application requirements. Actual performance is subject to the Omron's Warranty and Limitations of Liability.
4. **Change in Specifications.** Product specifications and accessories may be changed at any time based on improvements and other reasons. It is our practice to change part numbers when published ratings or features are changed, or when significant construction changes are made. However, some specifications of the Product may be changed without any notice. When in doubt, special part numbers may be assigned to fix or establish key specifications for your application. Please consult with your Omron's representative at any time to confirm actual specifications of purchased Product.
5. **Errors and Omissions.** Information presented by Omron Companies has been checked and is believed to be accurate; however, no responsibility is assumed for clerical, typographical or proofreading errors or omissions.

Complete "Terms and Conditions of Sale" for product purchase and use are on Omron's website at www.omron.com/oei – under the "About Us" tab, in the Legal Matters section.

ALL DIMENSIONS SHOWN ARE IN MILLIMETERS.

To convert millimeters into inches, multiply by 0.03937. To convert grams into ounces, multiply by 0.03527.

OMRON[®]

OMRON ELECTRONICS LLC

1 Commerce Drive
Schaumburg, IL 60173
Tel: 847.843.7900

For U.S. technical support or other inquiries: 800.556.6766

OMRON CANADA, INC.

885 Milner Avenue
Toronto, Ontario M1B 5V8
Tel: 416.286.6465

MEXICO SALES OFFICES

Mexico, D.F. (52) 555 660 31 44
Ciudad Juárez (52) 656 623 70 83
Monterrey, N.L. (52) 818 377 42 81
Mexicali, B.C. (52) 686 838 01 15

BRAZIL SALES OFFICES

Sao Paulo (55) 11 2101 6300

ARGENTINA SALES OFFICES

Cono Sur (54) 11 4787 1129

CHILE SALES OFFICES

Santiago (56) 2206 4592

OTHER LATIN AMERICAN SALES

mela@omron.com

OMRON ON-LINE

Global –
www.omron.com

USA –
www.omron247.com

Canada –
www.omron.ca

Brazil –
www.omron.com.br



SCATTERGOOD & JOHNSON LTD

ELECTRICAL ENGINEERING & FLUID CONTROL DISTRIBUTORS

Est.1899

At Scattergood & Johnson Ltd, we pride ourselves on being a technical distributor to specialist industries.

Working with a range of quality product suppliers across a number of specialist markets, we are not your average 'box shifter' - we are your technical and supply chain partner.

We fully support every product we sell - for free! Our internal team and external sales engineers can answer any product or application question, no matter the complexity.

Backing up this technical ability is a range of 50,000+ products available from stock for nationwide next day delivery (same day if required!), or you can collect what you need from any of our trade counters around the UK.

Select your specialist interest below to learn more about how we can help.

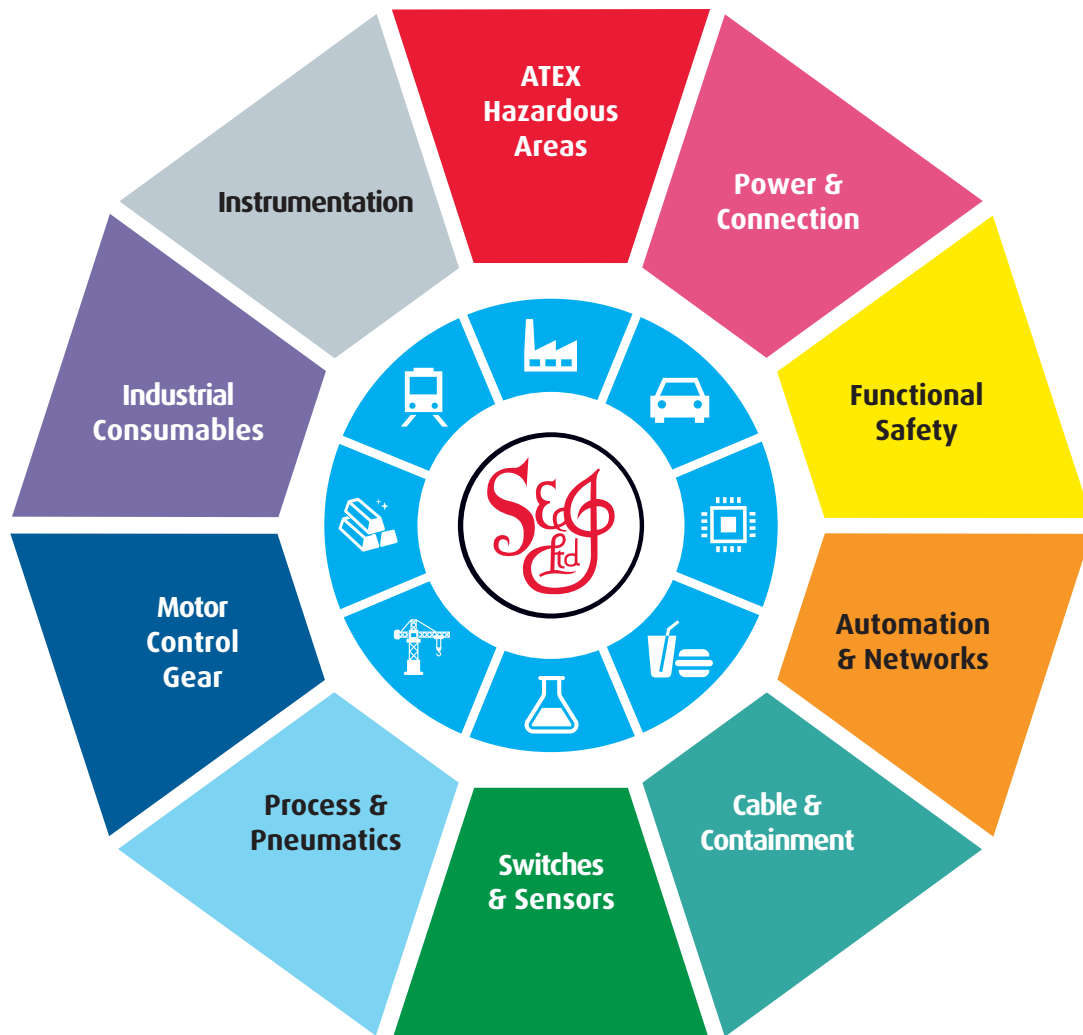

Online, In Branch and On the Road - Scattergood & Johnson Ltd, there when you need us.

www.scatts.co.uk