

Data plug - CUC-IND-C1ZNI-B/R4IE8 - 1421876



<https://www.phoenixcontact.com/il/products/1421876>

Please be informed that the data shown in this PDF document is generated from our Online Catalog. Please find the complete data in the user documentation. Our General Terms of Use for Downloads are valid.



RJ45 connector, degree of protection: IP20, number of positions: 8, 1 Gbps, CAT5 (IEC 11801:2002), material: Zinc die-cast, connection method: IDC fast connection, connection cross section: AWG 26- 24, cable outlet: angled, Ethernet

Your advantages

- assembly without special tools
- One-Piece Design
- AWG 26-24
- 360° shielding
- High shock and vibration resistance

Data plug - CUC-IND-C1ZNI-B/R4IE8 - 1421876



<https://www.phoenixcontact.com/il/products/1421876>

Commercial Data

Order Key	1421876
Packing unit	1 pc
Minimum order quantity	1 pc
Catalog Page	Page 373 (C-2-2019)
GTIN	4055626287560
Weight per Piece (including packing)	31.3 GRM
Weight per Piece (excluding packing)	31.0 GRM
Customs tariff number	85366990
Country of origin	PL

Data plug - CUC-IND-C1ZNI-B/R4IE8 - 1421876

<https://www.phoenixcontact.com/il/products/1421876>

Technical Data

Cable / line

Cable structure

Wire diameter including insulation	≤ 1.6 mm
External cable diameter	5 mm ... 9 mm
Cable diameter	5 mm ... 9 mm

Ambient conditions

Ambient temperature (operation)	-40 °C ... 70 °C (cable, fixed installation)
---------------------------------	--

Connector

Connection profile	RJ45
Insertion/withdrawal cycles	≥ 750

Environmental and real-life conditions

Ambient conditions

Ambient temperature (operation)	-40 °C ... 70 °C (cable, fixed installation)
Degree of protection	IP20

Notes

Environmental Product Compliance

China RoHS	Environmentally friendly use period: unlimited = EFUP-e No hazardous substances above threshold values
------------	---

Electrical properties

Frequency range	to 100 MHz
Rated current	1.75 A
Contact resistance	0.001 Ω (Wire – IDC) 0.005 Ω (Litz wires – IDC)
Nominal voltage U_N	48 V
Rated voltage (III/3)	72 V (DC)

Dimensions

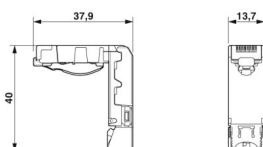
Dimensional drawing	
Length	13.65 mm
Height	40 mm
Width	37.95 mm

Data plug - CUC-IND-C1ZNI-B/R4IE8 - 1421876



<https://www.phoenixcontact.com/il/products/1421876>

Material specifications

Contact material	Copper alloy
Contact surface material	Gold over nickel
Housing material	Zinc die-cast
Flammability rating according to UL 94	V0
Contact carrier material	PC

Characteristics

Shielded	no
Cable outlet	angled
No. of cable outlets	1

Product properties

Number of positions	8
Type	RJ45, IP20
	RJ45

Insulation characteristics

Overvoltage category	I
----------------------	---

Data plug - CUC-IND-C1ZNI-B/R4IE8 - 1421876



<https://www.phoenixcontact.com/il/products/1421876>

Drawings

Dimensional drawing

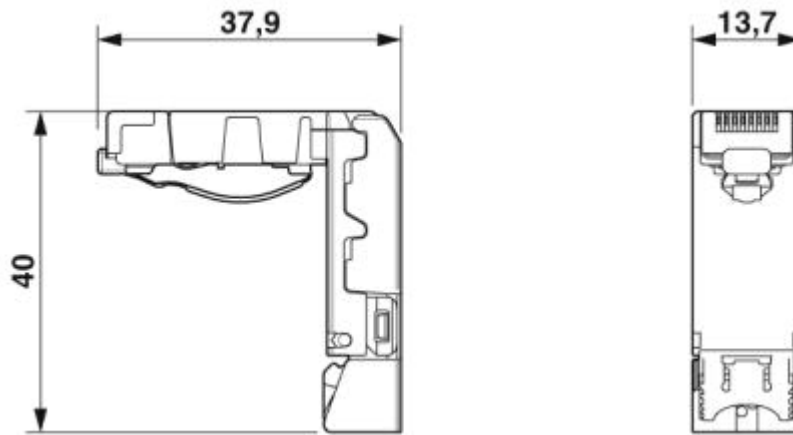

Data plug - CUC-IND-C1ZNI-B/R4IE8 - 1421876



<https://www.phoenixcontact.com/il/products/1421876>

Approvals

cULus Recognized 

Nominal voltage U_N

56.5 V

Nominal current I_N

0.175 A

EAC 

Data plug - CUC-IND-C1ZNI-B/R4IE8 - 1421876



<https://www.phoenixcontact.com/il/products/1421876>

Environmental Product Compliance

China RoHS

Environmentally friendly use period: unlimited = EFUP-e

No hazardous substances above threshold values

Data plug - CUC-IND-C1ZNI-B/R4IE8 - 1421876

<https://www.phoenixcontact.com/il/products/1421876>

Accessories

Patch panel

Patch panel - VS-PP-F-RJ45-CAT6 - 1658118

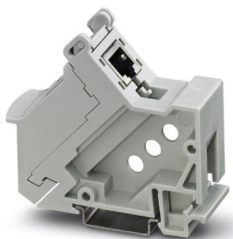

DIN rail adapter, degree of protection: IP20, number of positions: 8, 1 Gbps, CAT6, material: PC-GF, connection method: IDC fast connection, connection cross section: AWG 24- 22, color: gray

Patch panel

Patch panel - CUC-PP-D1PGY/R4GC8 - 1418094

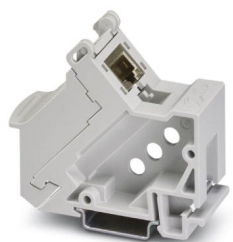

DIN rail adapter, type: RJ45, degree of protection: IP20, number of positions: 8, 1 Gbps, CAT6, material: PC-GF, connection method: Coupling, color: gray

Data plug - CUC-IND-C1ZNI-B/R4IE8 - 1421876

<https://www.phoenixcontact.com/il/products/1421876>

Data cable by the meter

Data cable by the meter - VS-OE-OE-94B-100,0 - 1416567



Network cable, Ethernet CAT5 (1 Gbps), 8-position, PUR halogen-free, water blue RAL 5021, shielded, free cable end, on free cable end, cable length: 100 m

Data cable by the meter

Data cable by the meter - VS-OE-OE-94B/... - 1417333



Network cable, Ethernet CAT5 (1 Gbps), 8-position, PUR halogen-free, water blue RAL 5021, shielded, free cable end, on free cable end, cable length: Free entry (0.5 ... 400 m)

Data plug - CUC-IND-C1ZNI-B/R4IE8 - 1421876

<https://www.phoenixcontact.com/il/products/1421876>

Female insert

Female insert - CUC-F-J1ZNI-S/R4IDC8 - 1418984

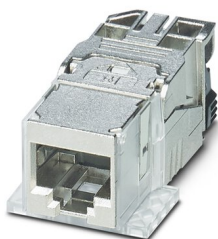

RJ45 socket insert, type: RJ45, degree of protection: IP20, number of positions: 8, 10 Gbps, CAT6_A, material: Zinc die-cast, connection method: IDC connection, connection cross section: AWG 26- 22, Freenet design for use with IP67 panel mounting frame and terminal outlets

Female insert

Female insert - CUC-F-D1ZNI-S/R4GC8 - 1419022

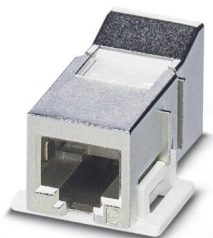

RJ45 coupling, type: RJ45, degree of protection: IP20, number of positions: 8, 1 Gbps, CAT6, material: Zinc die-cast

Data plug - CUC-IND-C1ZNI-B/R4IE8 - 1421876

<https://www.phoenixcontact.com/il/products/1421876>

Female insert

Female insert - CUC-K-J1ZNI-S/R4IDC8 - 1419021



RJ45 socket insert, type: RJ45, degree of protection: IP20, number of positions: 8, 10 Gbps, CAT6_A, material: Zinc die-cast, connection method: IDC connection, connection cross section: AWG 26- 22, Keystone design for use with IP20 panel mounting frame or integrated directly into the housing panel

Terminal marking

Terminal marking - TMT 5 R - 0816430



Marker for terminal blocks, Roll, white, unlabeled, can be labeled with: THERMOMARK ROLL 2.0, THERMOMARK ROLL, THERMOMARK ROLL X1, THERMOMARK ROLLMASTER 300/600, THERMOMARK X1.2, THERMOMARK S1.1, perforated, mounting type: snap into universal marker groove, snap into flat marker groove, for terminal block width: 5.2 mm, lettering field size: 6.4 x 5.15 mm, Number of individual labels: 19000

Data plug - CUC-IND-C1ZNI-B/R4IE8 - 1421876

<https://www.phoenixcontact.com/il/products/1421876>

Electronics pliers

Electronics pliers - MICROFOX-SP-1 - 1212487



Electronic diagonal cutter, tapered head, without chamfer, with opening spring, non-reflective phosphate-treated surface, punched version

Phoenix Contact 2021 © - all rights reserved
<https://www.phoenixcontact.com>

PHOENIX CONTACT Israel Ltd.
P.O.B. 1799 Industrial Park Hasharon
Quadima 60920
+972-9-8915700
info@phoenixcontact.co.il



SCATTERGOOD & JOHNSON LTD

ELECTRICAL ENGINEERING & FLUID CONTROL DISTRIBUTORS

Est.1899

At Scattergood & Johnson Ltd, we pride ourselves on being a technical distributor to specialist industries.

Working with a range of quality product suppliers across a number of specialist markets, we are not your average 'box shifter' - we are your technical and supply chain partner.

We fully support every product we sell - for free! Our internal team and external sales engineers can answer any product or application question, no matter the complexity.

Backing up this technical ability is a range of 50,000+ products available from stock for nationwide next day delivery (same day if required!), or you can collect what you need from any of our trade counters around the UK.

Select your specialist interest below to learn more about how we can help.



Online, In Branch and On the Road - Scattergood & Johnson Ltd, there when you need us.

www.scatts.co.uk