



Digital Modules ASi in IP20, 22,5 mm



Cost efficient solution in IP20



(Figure similar)

Figure	Type	Housing	Primary application ⁽¹⁾	Inputs digital	Outputs digital	Input voltage (sensor supply) ⁽²⁾	Output voltage (actuator supply) ⁽³⁾	ASi connection ⁽⁴⁾	ASi address ⁽⁵⁾	Article No.
	IP20, 22,5 mm x 50 mm, 4 x COMBICON	4 x COMBICON	decentralized control cabinet	4	4 x electronic	out of ASi	out of ASi	clamps	1 AB slave	BWU2783
	IP20, 22,5 mm x 50 mm, 4 x COMBICON	4 x COMBICON	decentralized control cabinet	4	4 x electronic	out of ASi	out of ASi	clamps	1 single slave	BWU3272
	IP20, 22,5 mm x 50 mm, 4 x COMBICON	3 x COMBICON	decentralized control cabinet	4	–	out of ASi	–	clamps	1 AB slave (S-0.A.7.0)	BWU3747
	IP20, 22,5 mm x 92 mm 4 x COMBICON	4 x COMBICON	control cabinet	4	4 x electronic	out of AUX	out of AUX	clamps	1 AB Slave	BWU3559
	IP20, 22,5 mm x 92 mm 4 x COMBICON	4 x COMBICON	control cabinet	4	4 x electronic	out of AUX	out of AUX	clamps	1 AB Slave	BWU3842
	IP20, 22,5 mm x 92 mm 4 x COMBICON	4 x COMBICON	control cabinet	4	3 x electronic	out of AUX	out of AUX	clamps	1 AB Slave	BWU3733
	IP20, 22,5 mm x 114 mm, 4 x COMBICON	3 x COMBICON	control cabinet	4	–	out of AUX	–	clamps	1 AB slave	BWU2723
	IP20, 22,5 mm x 114 mm, 4 x COMBICON	4 x COMBICON	control cabinet	4	4 x electronic	out of AUX	out of AUX	clamps	1 AB slave	BWU1938
	IP20, 22,5 mm x 114 mm, 4 x COMBICON	4 x COMBICON	control cabinet	4	4 x electronic	out of AUX	out of AUX	clamps	1 single slave	BWU2759
	IP20, 22,5 mm x 114 mm, 4 x COMBICON	4 x COMBICON	control cabinet	8	–	out of AUX	–	clamps	2 AB slaves	BWU2721
	IP20, 22,5 mm x 114 mm, 4 x COMBICON	4 x COMBICON	decentralized control cabinet	4	–	out of ASi	–	clamps	1 AB slave	BWU3265
	IP20, 22,5 mm x 114 mm, 4 x COMBICON	4 x COMBICON	decentralized control cabinet	4	–	out of AUX	–	clamps	1 AB slave	BWU3266

Digital Modules ASi in IP20, 22,5 mm

Figure	Type	Housing	Primary application ⁽¹⁾	Inputs digital	Outputs digital	Input voltage (sensor supply) ⁽²⁾	Output voltage (actuator supply) ⁽³⁾	ASi connection ⁽⁴⁾	ASi address ⁽⁵⁾	Article No.
	IP20, 22,5 mm x 114 mm, 6 x COMBICON	6 x COMBICON	control cabinet	4	3 x relay	out of ASi	–	clamps	1 AB slave	BWU3878
	IP20, 22,5 mm x 114 mm, 6 x COMBICON	6 x COMBICON	control cabinet	4	4 x relay	out of ASi	–	clamps	1 single slave	BWU3435
	IP20, 22,5 mm x 114 mm, 6 x COMBICON	6 x COMBICON	control cabinet	4	4 x relay	out of ASi	–	clamps	1 single slave (S-7.0.F.E)	BWU3658
	IP20, 22,5 mm x 114 mm, 6 x COMBICON	6 x COMBICON	control cabinet	4	4 x relay	out of ASi	–	clamps	1 AB slave	BWU3549
	IP20, 22,5 mm x 114 mm, 6 x COMBICON	6 x COMBICON	control cabinet	8	8 x electronic	out of ASi	out of AUX	clamps	2 AB slaves	BWU3364
	IP20, 22,5 mm x 114 mm, 6 x COMBICON	6 x COMBICON	control cabinet	8	8 x electronic	out of AUX	out of AUX	clamps	2 AB slaves	BWU2490
	IP20, 22,5 mm x 114 mm, 6 x COMBICON	6 x COMBICON	control cabinet	8	8 x electronic	out of AUX	out of AUX	clamps	2 single slaves	BWU2800
	IP20, 22,5 mm x 114 mm, 6 x COMBICON	6 x COMBICON	control cabinet	8 (NPN)	8 x electronic (NPN)	out of AUX	out of AUX	clamps	2 AB slaves	BWU3359
	IP20, 22,5 mm x 114 mm, 6 x COMBICON	6 x COMBICON	decentralized control cabinet	4	4 x electronic	out of ASi	out of AUX	clamps	1 AB slave	BWU3267
	IP20, 22,5 mm x 114 mm, 6 x COMBICON	6 x COMBICON	decentralized control cabinet	4	4 x electronic	out of AUX	out of AUX	clamps	1 AB slave	BWU3268
	IP20, 22,5 mm x 114 mm, 6 x COMBICON	6 x COMBICON	decentralized control cabinet	4	4 x electronic	out of ASi	out of AUX	clamps	1 single slave	BWU3754

(1) Primary Application

Control cabinet: Cost-optimized modules whereby the supply voltage for the sensors and actuators is connected via additional patch terminals. Optimal application in the main control cabinet.

Decentralized control cabinet: Ideal for use in decentralized control cabinets. 3-wire sensors or actuators can be connected directly to terminals in the module without additional patch terminals or the module has an extremely flat design.

(2) Input voltage (sensor supply): inputs are supplied by ASi or by AUX (auxiliary 24 V power). If supplied by ASi, inputs shall not be connected to earth or to external potential.

(3) Output voltage (actuator supply): outputs are supplied by ASi or by AUX (auxiliary 24 V power). If supplied by ASi, outputs shall not be connected to earth or to external potential

(4) ASi connection: the connection to ASi as well to AUX (auxiliary 24 V power) is made via yellow resp. black ASi profile cable with piercing technology or via M12 socket (in IP20 via clamps).

(5) ASi address: 1 AB slave (max. 62 AB slaves/ASi network), 2 AB slaves (max. 31 modules with 2 AB slaves), single slaves (max. 31 single slaves/ASi network), mixed use allowed.

For modules with two slaves the second slave is turned off as long as the first slave is addressed to address "0".

Upon request, slaves are available with specific ASi slave profiles.

Digital Modules ASi in IP20, 22,5 mm



Article no.	BWU3272		BWU2783	BWU3747
General data				
Device type	input / output			input
Connection				
ASi / AUX connection	COMBICON plug			
Periphery connection	COMBICON plug			
Primary application	decentralized control cabinet			
Length of connector cable	I/O: max. 15 m ⁽¹⁾			
ASi				
Profile	S-7.0.E, ID1=F (default)	S-7.A.7, ID1=7 (fixed)	S-0.A.0, ID1=7 (default)	
Address	1 single slave	1 AB slave		
Required Master profile	≥M0	≥M4	≥M3	
Since ASi specification	2	3.0	2.1	
Operating voltage	30 V (18 ... 31.6 V)			
Max. current consumption	165 mA			
Max. current consumption without sensor/ actuator supply	45 mA			
Input				
Number	4			
Power supply	out of ASi			
Sensor supply	short-circuit and overload protected according to EN 61131-2			
Power supply of attached sensors	up to +40 °C	120 mA, Σ (In/Out) 120 mA ⁽²⁾		120 mA, Σ (In) 120 mA ⁽⁵⁾
	at +55 °C	20 mA, Σ (In/Out) 20 mA ⁽²⁾		20 mA, Σ (In) 20 mA ⁽⁵⁾
Switching threshold	U<5 V (low) U>15 V (high)			
Output				
Number	4 x electronic			–
Power supply	out of ASi			–
Actuator supply	short-circuit and overload protected according to EN 61131			–
Max. output current	up to +40 °C	120 mA per output, Σ (In/Out) 120 mA ⁽²⁾		–
	at +55 °C	20 mA, Σ (In/Out) 20 mA ⁽²⁾		–
Display				
LED ASI (green)	an: ASi voltage on, flashing: ASi voltage on, but peripheral fault ⁽³⁾ or address 0 off: no ASi Voltage			
LED FLT/FAULT (red)	an: slave address 0 or slave offline flashing: peripheral fault ⁽³⁾ off: slave online			
LEDs I1 ... In (yellow)	state of inputs I1 ... I4			
LEDs O1 ... On (yellow)	state of outputs O1 ... O4			–

Digital Modules ASi in IP20, 22,5 mm



Article no.	BWU3272	BWU2783	BWU3747
Environment			
Applied standards	EN 61000-6-2 EN 61000-6-3 EN 61131 EN 60529		
Can be used in passively safe paths up to SIL3/PLe	yes ⁽⁴⁾		
Operating altitude	max. 2000 m		
Ambient temperature	-25 °C ... +40 °C (up to max. +55 °C) ⁽²⁾ no condensation permitted		
Storage temperature	-25 °C ... +85 °C		
Housing	plastic, for DIN rail mounting		
Pollution Degree	2		
Protection category	IP20		
Tolerable loading referring to humidity	according to EN 61131-2		
Voltage of insulation	≥500 V		
Weight	65 g		
Dimensions (W / H / D in mm)	22,5 / 99 / 50,5		

(1) Loop resistance ≤150 Ω

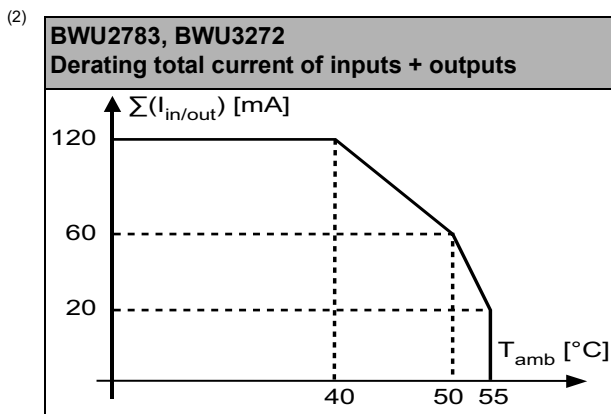

(3) see table „Peripheral fault indication“

(4) The module is suitable for use in passively safe paths as it has no connection to an AUX potential.

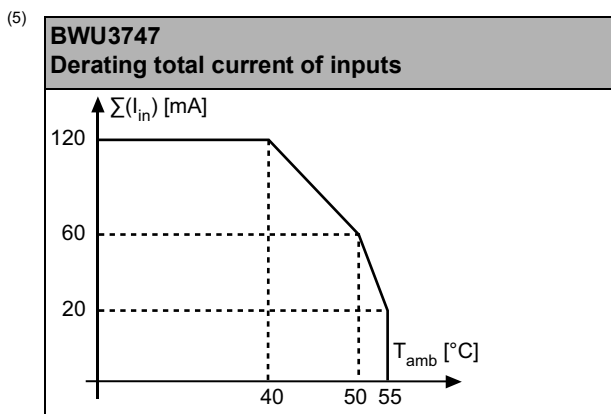

Digital Modules ASi in IP20, 22,5 mm



Article no.	BWU3265	BWU3266	BWU3268	BWU3267	BWU3754
General data					
Device type	input		input / output		
Connection					
ASi / AUX Connection	COMBICON plug				
Periphery connection	COMBICON plug				
Primary application	decentralized control cabinet				
Length of connector cable	I/O: unlimited ⁽¹⁾				
ASi					
Profile	S-7.A.E, ID1=7 (default)		S-7.A.7, ID1=7 (fixed)		S-7.0.E, ID1=F (default)
Address	1 AB slave				1 single slave
Required Master profile	≥M3		≥M4		≥M0
Since ASi specification	2.1		3.0		2
Operating voltage	30 V (18 ... 31.6 V)				
Max. current consumption	165 mA	35 mA		165 mA	
Max. current consumption without sensor/ actuator supply	45 mA	35 mA		45 mA	
AUX					
Voltage	–	24 V (18 ... 30 V)			
Max. current consumption	–	1,2 A	4,2 A	3 A	
Input					
Number	4				
Power supply	out of ASi	out of AUX		out of ASi	
Sensor supply	short-circuit and overload protected according to EN 61131-2				
power supply of attached sensors	up to +40 °C	120 mA ⁽²⁾	1200 mA permanent operation ⁽⁶⁾		120 mA ⁽²⁾
	at +55 °C	90 mA ⁽²⁾	900 mA permanent operation ⁽⁶⁾		90 mA ⁽²⁾
	at +70 °C	60 mA ⁽²⁾	600 mA permanent operation ⁽⁶⁾		60 mA ⁽²⁾
Switching threshold	U < 5 V (low) U > 15 V (high)				
Output					
Number	–		4 x electronic		
Power supply	–		out of AUX		
Actuator supply	short-circuit and overload protected according to EN 61131-2				
Max. output current	up to +50 °C	–		1 A per output, \sum (Out) 3,0 A ⁽⁸⁾	
	at +55 °C	–		1 A per output, \sum (Out) 2,5 A ⁽⁷⁾	
	at +70 °C	–		1 A per output, \sum (Out) 1,0 A ⁽⁷⁾	
Display					
LED ASi (green)	an: ASi voltage on, flashing: ASi voltage on, but peripheral fault ⁽³⁾ or address 0 off: no ASi Voltage				
LED FLT/FAULT (red)	an: slave address 0 or slave offline flashing: peripheral fault ⁽³⁾ off: slave online				
LEDs I1 ... I4 (yellow)	state of inputs I1 ... I4				
LEDs O1 ... O4 (yellow)	–		state of outputs O1 ... O4		
LED AUX (green)	–		on: 24 V _{DC} AUX off: no 24 V _{DC} AUX		

Digital Modules ASi in IP20, 22,5 mm

Article no.	BWU3265	BWU3266	BWU3268	BWU3267	BWU3754
Environment					
Applied standards	EN 61000-6-2 EN 61000-6-3 EN 61131 EN 60529				
Can be used in passively safe paths up to SIL3/PLe	yes ⁽⁴⁾	yes ⁽⁷⁾			
Operating altitude	max. 2000 m				
Ambient temperature	-25 °C ... +55 °C (up to max. +70 °C) ^{(2) (5)}	-25 °C ... +55 °C (up to max. +70 °C) ^{(5) (6) (7)}		-25 °C ... +55 °C (up to max. +70 °C) ^{(2) (5) (7)}	
	no condensation permitted				
Storage temperature	-25 °C ... +85 °C ^{(2) (3)}				
Housing	plastic, for DIN rail mounting				
Pollution Degree	2				
Protection category	IP20				
Tolerable loading referring to humidity	according to EN 61131-2				
Voltage of insulation	≥500 V				
Weight	120 g				
Dimensions (W / H / D in mm)	22,5 / 99 / 114				

(1) Loop resistance ≤150 Ω

(2)

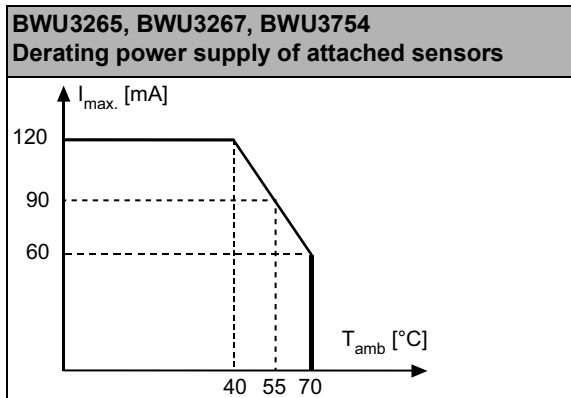

(3) see table „peripheral fault indication“

(4) The module is suitable for use in passively safe paths as it has no connection to an AUX potential.

(5) Maximum ambient operating temperature +55 °C according UL certificate for the use in the USA and Canada.

(6)

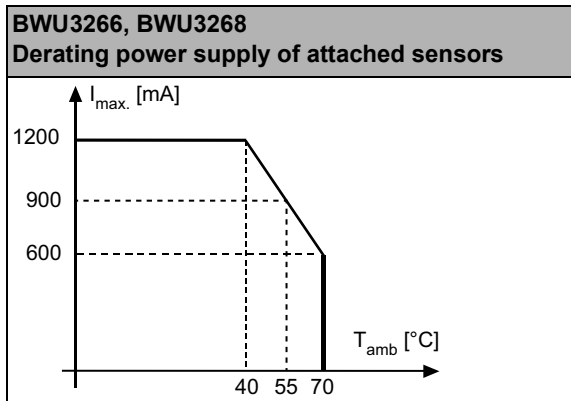

(7) BWU3266 from Ident. No. 18368; BWU3268 from Ident. No. 17368; BWU3267 from Ident. No. 17051; BWU3754 from Ident. No. 17355; The module is suitable for use in passively safe paths because an exclusion of errors can be assumed for the connection of the two potentials, ASi and AUX.

Digital Modules ASi in IP20, 22,5 mm

(8)

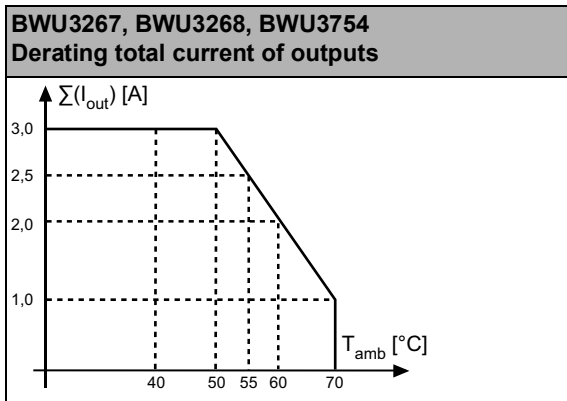

Article no.	BWU2723	BWU3842	BWU1938	BWU3559	BWU3733	BWU2759
General data						
Device type	input		inputs / output			
Connection						
ASi / AUX Connection			COMBICON plug			
Periphery connection			COMBICON plug			
Primary application			control cabinet			
Length of connector cable			I/O: unlimited ⁽¹⁾			
ASi						
Profile	S-7.A.E, ID1=7 (default)		S-7.A.7, ID1=7 (fixed)		S-7.A.0, ID1=7 (default)	S-7.0.E, ID1=F (default)
Address			1 AB slave			1 single slave
Required Master profile	≥M3		≥M4		≥M3	≥M0
Since ASi specification	2.1		3.0		2.1	2
Operating voltage			30 V (18 ... 31.6 V)			
Max. current consumption			35 mA			
Max. current consumption without sensor/ actuator supply			35 mA			
AUX						
Voltage			24 V (18 ... 30 V)			
Max. current consumption	1,2 A	8 A	4 A			
Input						
Number			4			
Power supply			out of AUX			
Sensor supply			short-circuit and overload protected according to EN 61131			
power supply of attached sensors	up to +40 °C	1200 mA permanent operation ⁽²⁾	< 500 mA	1200 mA permanent operation ⁽²⁾		
	at +55 °C	900 mA permanent operation ⁽²⁾		900 mA permanent operation ⁽²⁾		
	at +70 °C	600 mA permanent operation ⁽²⁾		600 mA permanent operation ⁽²⁾		
Switching threshold			U<5 V (low) U>15 V (high)			

Digital Modules ASi in IP20, 22,5 mm



Article no.	BWU2723	BWU3842	BWU1938	BWU3559	BWU3733	BWU2759
Output						
Number	–	4 x electronic			3 x electronic	4 x electronic
Power supply	–	out of AUX				
Actuator supply	short-circuit and overload protected according to EN 61131					
Max. output current	up to +50 °C	–	2 A per output, Σ (In/Out) 8 A ⁽⁶⁾	1 A per output, Σ (Out) 3,0 A ⁽⁷⁾		
	at +55 °C		2 A per output, Σ (In/Out) 4 A ⁽⁶⁾	1 A per output, Σ (Out) 2,5 A ⁽⁷⁾		
	at +70 °C		2 A per output, Σ (In/Out) 2 A ⁽⁶⁾	1 A per output, Σ (Out) 1,0 A ⁽⁷⁾		
Display						
LED ASI (green)	an: ASi voltage on, flashing: ASi voltage on, but peripheral fault ⁽³⁾ or address 0 off: no ASi Voltage					
LED FLT/FAULT (red)	an: slave address 0 or slave offline flashing: peripheral fault ⁽³⁾ off: slave online					
LEDs I1 ... In (yellow)	state of inputs I1 ... I4					
LEDs O1 ... On (yellow)	–	state of outputs O1 ... O4				
LED AUX (green)	on: 24 V _{DC} AUX off: no 24 V _{DC} AUX					
Environment						
Applied standards	EN 61000-6-2 EN 61000-6-3 EN 61131 EN 60529					
Can be used in passively safe paths up to SIL3/PLe	yes ⁽⁴⁾			no ⁽⁸⁾		yes ⁽⁹⁾
Operating altitude	max. 2000 m					
Ambient temperature	-25 °C ... +55 °C C (up to max. +70 °C) ⁽²⁾⁽⁵⁾	-25 °C ... +55 °C (up to max. +70 °C) ⁽²⁾⁽⁵⁾⁽⁶⁾⁽⁷⁾				
		no condensation permitted				
Storage temperature	-25 °C ... +85 °C					
Housing	plastic, for DIN rail mounting					
Pollution Degree	2					
Protection category	IP20					
Tolerable loading referring to humidity	according to EN 61131-2					
Voltage of insulation	≥500 V					
Weight	120 g					
Dimensions (W / H / D in mm)	22,5 / 99 / 114	22,5 / 99 / 92	22,5 / 99 / 114	22,5 / 99 / 92		22,5 / 99 / 114

(1) Loop resistance ≤150 Ω

Digital Modules ASi in IP20, 22,5 mm

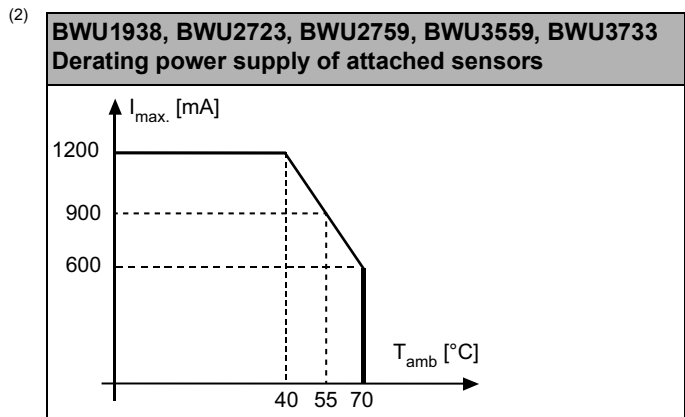

(3) see table „peripheral fault indication“

(4) BWU2723 from Ident. No. 18206; BWU3842 from Ident. No. 18488; BWU1938 from Ident. No. 18430; BWU3559 from Ident. No. 18507; The module is suitable for use in passively safe paths because an exclusion of errors can be assumed for the connection of the two potentials, ASi and AUX.

(5) Maximum ambient operating temperature +55 °C according UL certificate for the use in the USA and Canada.

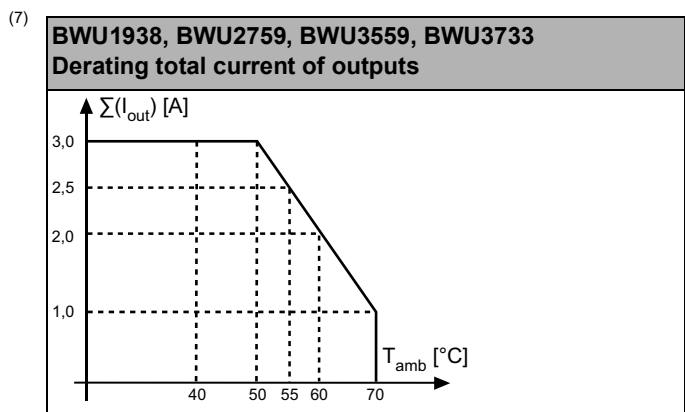
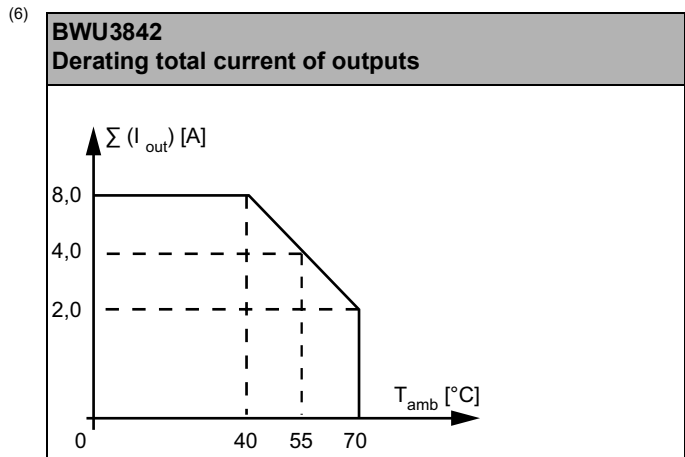

(8) The module is not suitable for use in passively safe paths because an exclusion of errors cannot be assumed for the connection of the two potentials, ASi and AUX.

(9) BWU2759 from Ident. No. 18506; the module is suitable for use in passively safe paths because an exclusion of errors can be assumed for the connection of the two potentials, ASi and AUX.

Article no.	BWU3364	BWU2490	BWU2800	BWU2721	BWU3359
General data					
Device type	input / output			input	input / output
Connection					
ASi / AUX connection	COMBICON plug				
Periphery connection	COMBICON plug				

Digital Modules ASi in IP20, 22,5 mm



Article no.	BWU3364	BWU2490	BWU2800	BWU2721	BWU3359
Primary application	control cabinet				
Length of connector cable	I/O: unlimited ⁽¹⁾				
ASi					
Profile	slave 1: S-7.A.7, ID1=7 (fixed), slave 2: S-7.A.7, ID1=6 (default)		slave 1: S-7.0.E, ID1=F (default) slave 2: S-7.0.E, ID1=E (default)	slave 1: S-7.A.E, ID1=7 (default) slave 2: S-7.A.E, ID1=6 (default)	slave 1: S-7.A.7, ID1=7 (fixed), slave 2: S-7.A.7, ID1=6 (default)
Address	2 AB slaves		2 single slaves	2 AB slaves	
Required Master profile	≥M4		≥M0	≥M3	≥M4
Since ASi specification	3.0		2.0	2.1	3.0
Operating voltage	30 V (18 ... 31.6 V)				
Max. current consumption	320 mA	60 mA			
Max. current consumption without sensor/ actuator supply	60 mA	60 mA			
AUX					
Voltage	24 V (18 ... 30 V)				
Max. current consumption	8 A			1,2 A	8 A
Input					
Number	8			8 (NPN)	
Power supply	out of ASi		out of AUX		
Sensor supply	short-circuit and overload protected according to EN 61131				
Power supply of attached sensors	up to +40 °C	260 mA ⁽²⁾	900 mA permanent operation ⁽⁶⁾		1200 mA permanent operation ⁽¹⁰⁾
	at +55 °C	130 mA ⁽²⁾	700 mA permanent operation ⁽⁶⁾		900 mA permanent operation ⁽¹⁰⁾
	at +70 °C	–	600 mA permanent operation ⁽⁶⁾		600 mA permanent operation ⁽¹⁰⁾
Switching threshold	U<5 V (low) U>15 V (high)				ground I+ -U<5 V (low) -U>15 V (high)
Output					
Number	8 x electronic			–	8 x electronic (NPN)
Power supply	out of AUX			–	out of AUX
Actuator supply	short-circuit and overload protected according to EN 61131				
Max. output current	up to +40 °C	1 A per output, $\sum (O1 \dots O4) 3 A +$ $\sum (O5 \dots O8) 3 A$ 3 A ⁽³⁾	1 A per output, $\sum (O1 \dots O4) 3 A +$ $\sum (O5 \dots O8) 3 A$ ⁽⁷⁾		0,5 A per output, $\sum (Out) 4 A$ ⁽¹¹⁾
	at +55 °C	1 A per output, $\sum (O1 \dots O4) 2 A +$ $\sum (O5 \dots O8) 2 A$ 2 A ⁽³⁾	–		
	at +70 °C	–	1 A per output, $\sum (O1 \dots O8) 1 A$ ⁽⁷⁾		0,5 A per output, $\sum (Out) 0,5 A$ ⁽¹¹⁾
Display					
LED ASI/FLT 1 (red/green)	green: slave online red: slave offline yellow/red flashing: address 0				
LED ASI/FLT 2 (red/green)	green: slave online red: slave offline yellow/red flashing: address 0 red/green flashing: peripheral fault ⁽⁴⁾ red flashing: slave 2 is switched off, because slave 1 is offline				
LEDs I1 ... In (yellow)	state of inputs I1 ... I8				
LEDs O1 ... On (yellow)	state of outputs O1 ... O8			–	state of outputs O1 ... O8
LED AUX (green)	on: 24 V _{DC} AUX off: no 24 V _{DC} AUX				

Digital Modules ASi in IP20, 22,5 mm



Article no.	BWU3364	BWU2490	BWU2800	BWU2721	BWU3359
Environment					
Applied standards	EN 61000-6-2 EN 61000-6-3 EN 61131 EN 60529				
Can be used in passively safe paths up to SIL3/PLe	yes ⁽⁵⁾				no ⁽¹²⁾
Operating altitude	max. 2000 m				
Ambient temperature	30 °C ... +55 °C ^{(2) (3)}	-30 °C ... +55 °C (up to max. +70 °C) ^{(6) (7) (8) (9)}		-30 °C ... +55 °C (up to max. +70 °C) ^{(8) (10) (11)}	
	no condensation permitted				
Storage temperature	-25 °C ... +85 °C				
Housing	plastic, for DIN rail mounting				
Pollution Degree	2				
Protection category	IP20				
Tolerable loading referring to humidity	according to EN 61131-2				
Voltage of insulation	≥500 V				
Weight	120 g				
Dimensions (W / H / D in mm)	22,5 / 99 / 114				

(1) Loop resistance ≤150 Ω

(2)

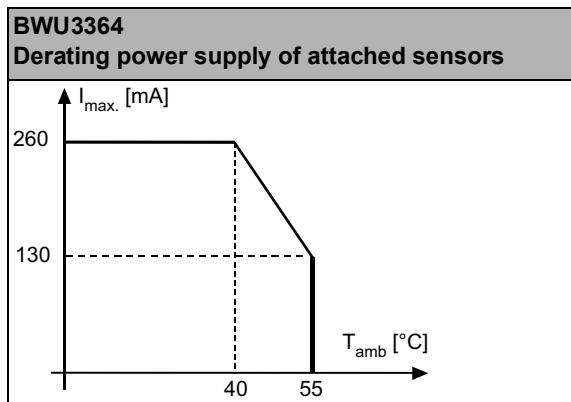

(3)

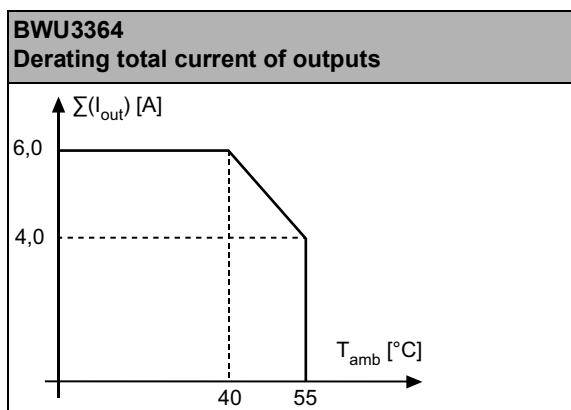

(4) see table „peripheral fault indication“

(5) BWU3364 from Ident. No. 18441; BWU2490 from Ident. No. 18307; BWU2800 from Ident. No. 18544; BWU2721 from Ident. No. 18264; the module is suitable for use in passively safe paths because an exclusion of errors can be assumed for the connection of the two potentials, ASi and AUX.

Digital Modules ASi in IP20, 22,5 mm

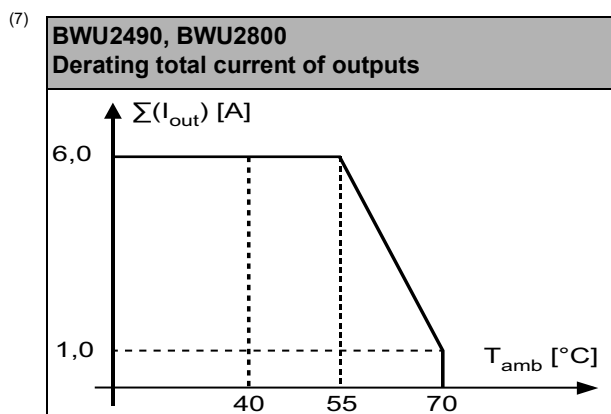
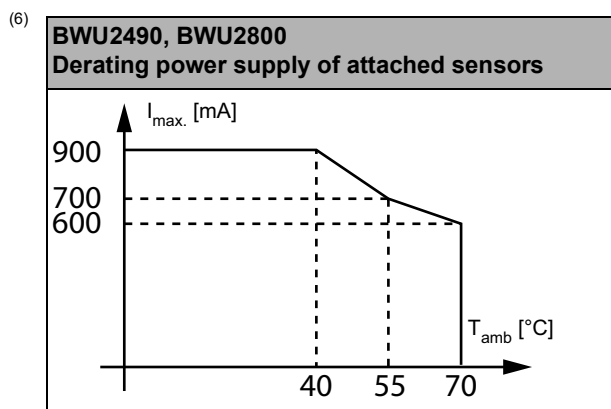

(8) Maximum ambient operating temperature +55 °C according UL certificate for the use in the USA and Canada.

(9) Temperature range up to -30°C from Ident.No. ≥16283 (BWU2490); Ident.No. ≥16299 (BWU2800).

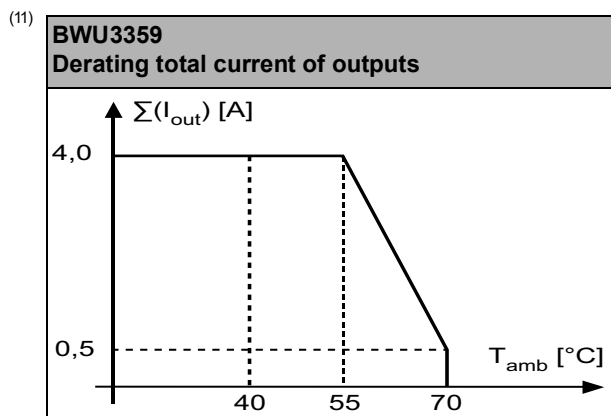
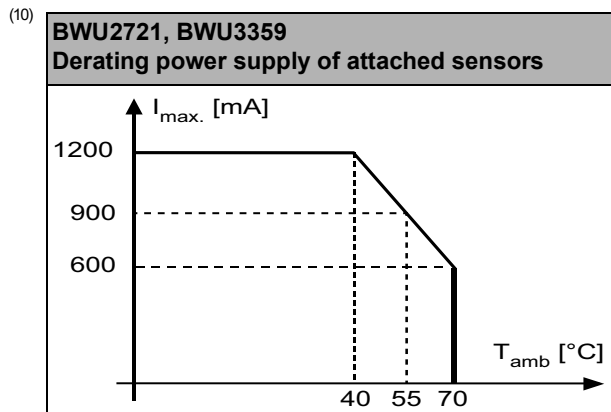

(12) The module is not suitable for use in passively safe paths because an exclusion of errors cannot be assumed for the connection of the two potentials, ASi and AUX.

Digital Modules ASi in IP20, 22,5 mm



Article no.	BWU3878	BWU3435	BWU3658	BWU3549
General data				
Device type	input / output			
Connection				
ASi / AUX Connection	COMBICON plug			
Periphery connection	COMBICON plug			
Primary application	control cabinet			
Length of connector cable	I/O: unlimited ⁽¹⁾			
ASi				
Profile	S.7.A.7.0	S-7.F.E, ID1=F (default)	S-7.0.E, ID1=F (default)	S-7.A.7, ID=7(fixed)
Address	1 AB slave	1 single slave		1 AB slave
Required Master profile	≥M0			≥M4
Since ASi specification	2			3
Operating voltage	30 V (26,5 ... 31.6 V)			
Max. current consumption	200 mA		165 mA	
Max. current consumption without sensor/ actuator supply	45 mA			
Input				
Number	4			
Power supply	out of ASi			
Sensor supply	short-circuit and overload protected according to EN 61131			
Power supply of attached sensors	up to +40 °C	120 mA ⁽²⁾		120 mA ⁽⁶⁾
	at +55 °C	90 mA ⁽²⁾		90 mA ⁽⁶⁾
	at +70 °C	60 mA ⁽²⁾		60 mA ⁽⁶⁾
Switching threshold	U<5 V (low) U>15 V (high)			
Output				
Number	3 x relay outputs, normally open, 230 VAC/2A/AC-14, 30 VDC/2A/DC-13 Σ (Out) 8 A	4 x relay outputs, normally open, 230 VAC/2A/AC-14, 30 VDC/2A/DC-13 Σ (Out) 8 A		
Relay control	out of ASi			
Max. output current	-			
Display				
LED ASi (green)	an: ASi voltage on, flashing: ASi voltage on, but peripheral fault ⁽³⁾ or address 0 off: no ASi Voltage			
LED FLT/FAULT (red)	an: slave address 0 or slave offline flashing: peripheral fault ⁽³⁾ off: slave online			
LEDs I1 ... I4 (yellow)	state of inputs I1 ... I4			
LEDs O1 ... O4 (yellow)	state of outputs O1 ... O3	state of outputs O1 ... O4		

Digital Modules ASi in IP20, 22,5 mm



Article no.	BWU3878	BWU3435	BWU3658	BWU3549
Environment				
Applied standards	EN 61000-6-2 EN 61000-6-3 EN 61131 EN 60529			
Can be used in passively safe paths up to SIL3/PLe	yes ⁽⁴⁾			
Operating altitude	max. 2000 m			
Ambient temperature	-25 °C ... +55 °C (up to max. +70 °C) ^{(2) (5)}		-25 °C ... +55 °C (up to max. +70 °C) ^{(5) (6)}	
	no condensation permitted			
Storage temperature	-25 °C ... +85 °C			
Housing	plastic, for DIN rail mounting			
Pollution Degree	2			
Protection category	IP20			
Tolerable loading referring to humidity	according to EN 61131-2			
Voltage of insulation	≥500 V			
Weight	120 g			
Dimensions (W / H / D in mm)	22,5 / 99 / 114			

(1) Loop resistance ≤150 Ω

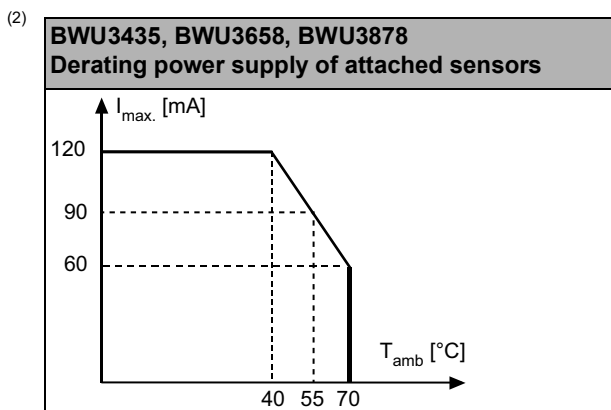

(3) see table "Peripheral fault indication"

(4) The module is suitable for use in passively safe paths as it has no connection to an AUX potential.

(5) Maximum ambient operating temperature +55 °C according UL certificate for the use in the USA and Canada.

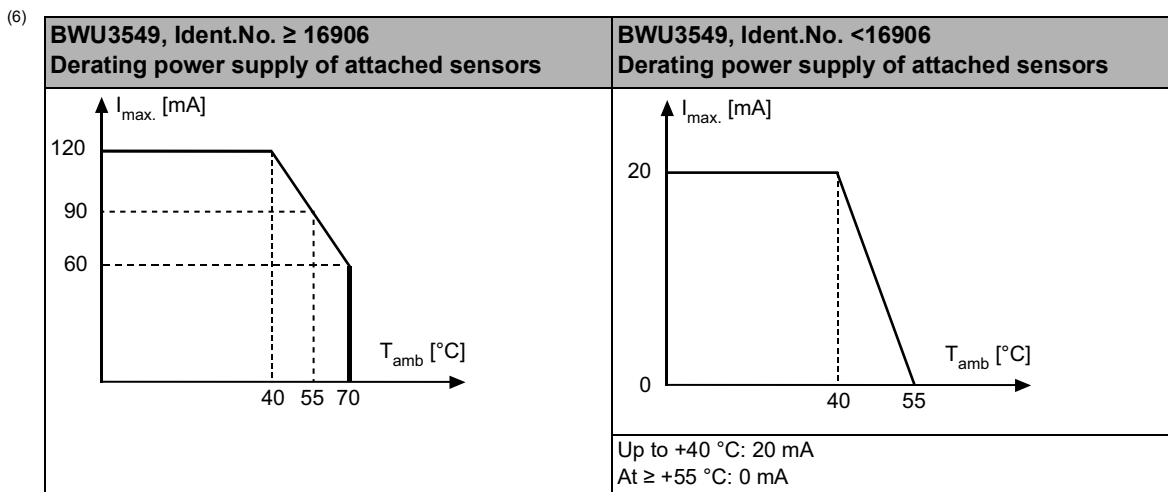

Digital Modules ASi in IP20, 22,5 mm



Wiring rules

Push-in terminals	
General	
Nominal cross section	2.5 mm ²
Conductor cross section	
Conductor cross section solid	0.2 ... 2.5 mm ²
Conductor cross section flexible	0.2 ... 2.5 mm ²
Conductor cross section flexible, with ferrule	without plastic sleeve: 0.2 ... 2.5 mm ²
	with plastic sleeve: 0.25 ... 2.5 mm ²
2 conductors with same cross section, stranded, with TWIN ferrules	without plastic sleeve: 0.5 ... 1.5 mm ²
AWG	24 ... 14
Stripped insulation length	10 mm

UL-specifications (UL508)	
External protection	An isolated source with a secondary open circuit voltage of $\leq 30 V_{DC}$ with a 3 A maximum over current protection. Over current protection is not required when a Class 2 source is employed.
In general	UL mark does not provide UL certification for any functional safety rating or aspects of the above devices.

Article no.	Peripheral fault indication	
	Overload sensor supply	AUX voltage missing
BWU1938	-	•
BWU2490	-	•
BWU2721	-	•
BWU2723	-	•
BWU2759	-	•
BWU2783	•	-
BWU2800	-	•
BWU3265	•	-
BWU3266	•	•
BWU3267	•	•
BWU3268	•	•
BWU3272	•	-
BWU3359	-	•
BWU3364	•	•
BWU3435	•	-
BWU3549	•	-
BWU3559	-	•
BWU3658	•	-
BWU3733	-	•
BWU3747	•	-
BWU3754	•	•
BWU3842	-	•
BWU3878	•	-

Digital Modules ASi in IP20, 22,5 mm



Programming	Bit setting			
	D3	D2	D1	D0
	Input			
BWU1938 / BWU2723 / BWU2759 / BWU2783 / BWU3265 / BWU3266 / BWU3267 / BWU3268 / BWU3272 / BWU3435 / BWU3549 / BWU3559 / BWU3658 / BWU3733 / BWU3747 / BWU3754 / BWU3842 / BWU3878	I4	I3	I2	I1
BWU2490 / BWU2721 / BWU2800 / BWU3359 / BWU3364	slave 1: I4	slave 1: I3	slave 1: I2	slave 1: I1
	slave 2: I8	slave 2: I7	slave 2: I6	slave 2: I5
	output			
BWU1938 / BWU2759 / BWU2783 / BWU3267 / BWU3268 / BWU3272 / BWU3435 / BWU3549 / BWU3559 / BWU3658 / BWU3754 / BWU3842	O4	O3	O2	O1
BWU3373, BWU3878	–	O3	O2	O1
BWU2490 / BWU2800 / BWU3359 / BWU3364	slave 1: O4	slave 1: O3	slave 1: O2	slave 1: O1
	slave 2: O8	slave 2: O7	slave 2: O6	slave 2: O5

Programming	Bit setting			
	parameter bit			
	P3	P2	P1	P0
BWU3364 / BWU2723 / BWU2721 / BWU3265 / BWU3266	not used	0 = on / 1 = off (synchronous I/O mode)	0 = on / 1 = off (data input filter 128 µs)	0 = off / 1 = on (peripheral fault, if AUX voltage missing)
BWU1938 / BWU2759 / BWU2783 / BWU3267 / BWU3268 / BWU3272 / BWU3435 / BWU3549 / BWU3559 / BWU3658 / BWU3733 / BWU3754 / BWU3842 / BWU3878				0 = off / 1 = on (watchdog)
BWU2490 / BWU2800 / BWU3359 / BWU3747				not used, watchdog always on

Connections

Name	Explanation
I _x	digital input x
O _x	digital output x
O _{x3} , O _{x4}	relay output x
I ₊ , I ₋ , I ₊ _n , I ₋ _n	sensor supply
O ₋ _n	GND for outputs (PNP)
O ₊ _n	GND for outputs (NPN)
AUX ⁺ _{ext.in}	power supply, out of external voltage, positive pole (AUX, actuator supply)
AUX ⁻ _{ext.in}	power supply, out of external voltage, negative pole (AUX, actuator supply)
ASi ⁺ , ASi ⁻	connection to ASi bus
ADDR	connection for ASi addressing device
n.c. (not connected)	not connected

Digital Modules ASi in IP20, 22,5 mm



Connections		
<p>BWU3265</p>	<p>BWU3266</p>	<p>BWU2723</p>
<p>BWU2783 / BWU3272</p>	<p>BWU1938 / BWU2759 / BWU3559 / BWU3842</p>	<p>BWU2721</p>
<p>BWU3267 / BWU3268</p>	<p>BWU2490 / BWU2800 / BWU3364</p>	<p>BWU3359</p>

Digital Modules ASI in IP20, 22,5 mm



Connections																																																														
<p>BWU3733</p> <p> <table border="1"> <tr><td>I-1</td><td>I+1</td><td>O-1</td><td>O+1</td></tr> <tr><td>I4</td><td>I3</td><td>I2</td><td>I1</td></tr> </table> <table border="1"> <tr><td>O1</td><td>O2</td><td>O3</td><td>n.c.</td></tr> <tr><td>ASI+</td><td>ASI-</td><td>AUX+ ext.in</td><td>AUX- ext.in</td></tr> </table> </p>	I-1	I+1	O-1	O+1	I4	I3	I2	I1	O1	O2	O3	n.c.	ASI+	ASI-	AUX+ ext.in	AUX- ext.in	<p>BWU3747</p> <p> <table border="1"> <tr><td>I-1</td><td>I+1</td><td>I-1</td><td>I-1</td></tr> <tr><td>I4</td><td>I3</td><td>I2</td><td>I1</td></tr> </table> <table border="1"> <tr><td>ASI+</td><td>ASI-</td><td>n.c.</td><td>n.c.</td></tr> </table> </p>	I-1	I+1	I-1	I-1	I4	I3	I2	I1	ASI+	ASI-	n.c.	n.c.																																	
I-1	I+1	O-1	O+1																																																											
I4	I3	I2	I1																																																											
O1	O2	O3	n.c.																																																											
ASI+	ASI-	AUX+ ext.in	AUX- ext.in																																																											
I-1	I+1	I-1	I-1																																																											
I4	I3	I2	I1																																																											
ASI+	ASI-	n.c.	n.c.																																																											
<p>BWU3435</p> <p> <table border="1"> <tr><td>O41</td><td>O43</td><td>O34</td><td>O33</td></tr> <tr><td>O24</td><td>O23</td><td>O14</td><td>O13</td></tr> </table> <table border="1"> <tr><td>I+1</td><td>I-1</td><td>I+2</td><td>I-2</td></tr> <tr><td>I1</td><td>I2</td><td>I3</td><td>I4</td></tr> </table> <table border="1"> <tr><td>ASI+</td><td>ASI-</td><td>n.c.</td><td>n.c.</td></tr> </table> </p>	O41	O43	O34	O33	O24	O23	O14	O13	I+1	I-1	I+2	I-2	I1	I2	I3	I4	ASI+	ASI-	n.c.	n.c.	<p>BWU3549</p> <p> <table border="1"> <tr><td>O41</td><td>O43</td><td>O34</td><td>O33</td></tr> <tr><td>O24</td><td>O23</td><td>O14</td><td>O13</td></tr> </table> <table border="1"> <tr><td>I+1</td><td>I-1</td><td>I+2</td><td>I-2</td></tr> <tr><td>I1</td><td>I2</td><td>I3</td><td>I4</td></tr> </table> <table border="1"> <tr><td>ASI+</td><td>ASI-</td><td>n.c.</td><td>n.c.</td></tr> </table> </p>	O41	O43	O34	O33	O24	O23	O14	O13	I+1	I-1	I+2	I-2	I1	I2	I3	I4	ASI+	ASI-	n.c.	n.c.	<p>BWU3658</p> <p> <table border="1"> <tr><td>O44</td><td>O43</td><td>O34</td><td>O33</td></tr> <tr><td>O24</td><td>O23</td><td>O14</td><td>O13</td></tr> </table> <table border="1"> <tr><td>I+1</td><td>I-1</td><td>I+2</td><td>I-2</td></tr> <tr><td>I1</td><td>I2</td><td>I3</td><td>I4</td></tr> </table> <table border="1"> <tr><td>ASI+</td><td>ASI-</td><td>n.c.</td><td>n.c.</td></tr> </table> </p>	O44	O43	O34	O33	O24	O23	O14	O13	I+1	I-1	I+2	I-2	I1	I2	I3	I4	ASI+	ASI-	n.c.	n.c.
O41	O43	O34	O33																																																											
O24	O23	O14	O13																																																											
I+1	I-1	I+2	I-2																																																											
I1	I2	I3	I4																																																											
ASI+	ASI-	n.c.	n.c.																																																											
O41	O43	O34	O33																																																											
O24	O23	O14	O13																																																											
I+1	I-1	I+2	I-2																																																											
I1	I2	I3	I4																																																											
ASI+	ASI-	n.c.	n.c.																																																											
O44	O43	O34	O33																																																											
O24	O23	O14	O13																																																											
I+1	I-1	I+2	I-2																																																											
I1	I2	I3	I4																																																											
ASI+	ASI-	n.c.	n.c.																																																											
<p>BWU3754</p> <p> <table border="1"> <tr><td>I-1</td><td>I-2</td><td>I-2</td><td>I-1</td></tr> <tr><td>I4</td><td>I3</td><td>I2</td><td>I1</td></tr> <tr><td>I+1</td><td>I+2</td><td>I+2</td><td>I+1</td></tr> </table> <table border="1"> <tr><td>O-1</td><td>O-2</td><td>O-1</td><td>O-1</td></tr> <tr><td>O1</td><td>O2</td><td>O3</td><td>O4</td></tr> </table> <table border="1"> <tr><td>ASI+</td><td>ASI-</td><td>AUX+ ext.in</td><td>AUX- ext.in</td></tr> </table> </p>	I-1	I-2	I-2	I-1	I4	I3	I2	I1	I+1	I+2	I+2	I+1	O-1	O-2	O-1	O-1	O1	O2	O3	O4	ASI+	ASI-	AUX+ ext.in	AUX- ext.in	<p>BWU3878</p> <p> <table border="1"> <tr><td>n.c.</td><td>n.c.</td><td>O34</td><td>O33</td></tr> <tr><td>O24</td><td>O23</td><td>O14</td><td>O13</td></tr> </table> <table border="1"> <tr><td>I+1</td><td>I-1</td><td>I+2</td><td>I-2</td></tr> <tr><td>I1</td><td>I2</td><td>I3</td><td>I4</td></tr> </table> <table border="1"> <tr><td>ASI+</td><td>ASI-</td><td>n.c.</td><td>n.c.</td></tr> </table> </p>	n.c.	n.c.	O34	O33	O24	O23	O14	O13	I+1	I-1	I+2	I-2	I1	I2	I3	I4	ASI+	ASI-	n.c.	n.c.																	
I-1	I-2	I-2	I-1																																																											
I4	I3	I2	I1																																																											
I+1	I+2	I+2	I+1																																																											
O-1	O-2	O-1	O-1																																																											
O1	O2	O3	O4																																																											
ASI+	ASI-	AUX+ ext.in	AUX- ext.in																																																											
n.c.	n.c.	O34	O33																																																											
O24	O23	O14	O13																																																											
I+1	I-1	I+2	I-2																																																											
I1	I2	I3	I4																																																											
ASI+	ASI-	n.c.	n.c.																																																											

Digital Modules ASi in IP20, 22,5 mm



Power supply PNP

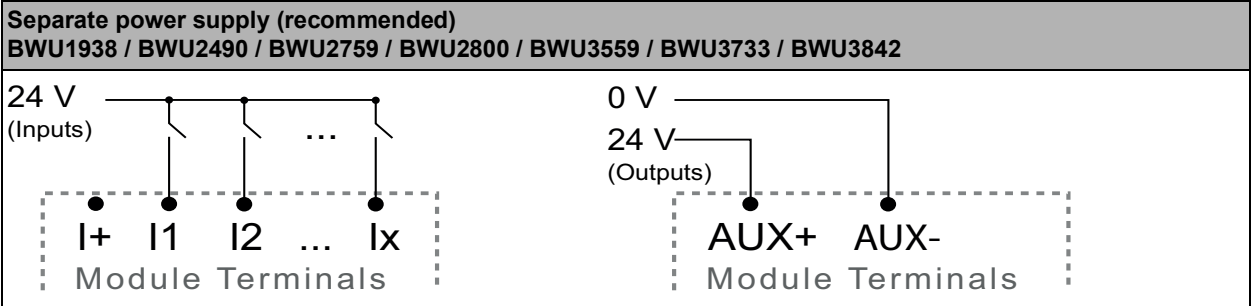
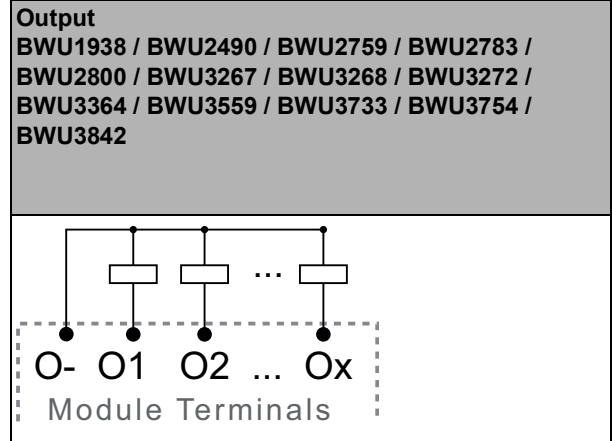
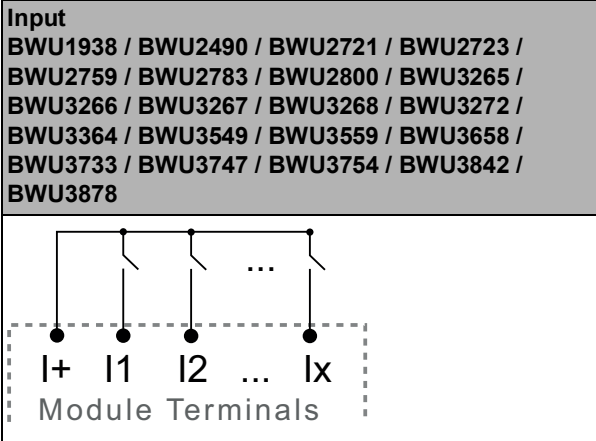

Power supply NPN

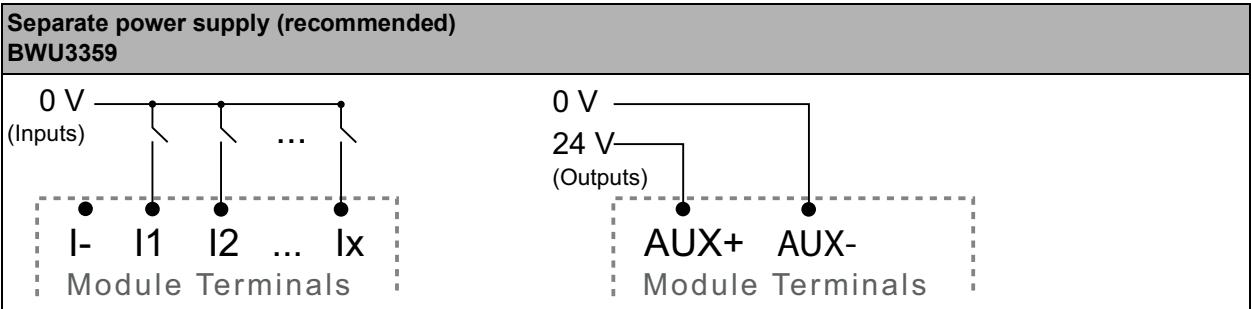
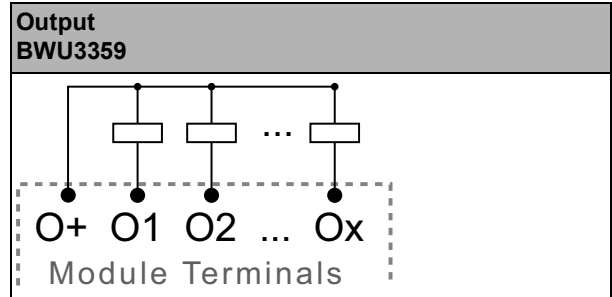
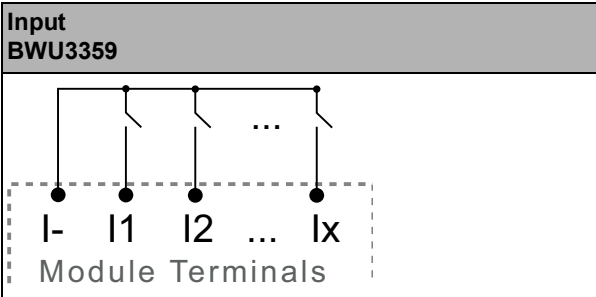

Digital Modules ASi in IP20, 22,5 mm



Connection relay output

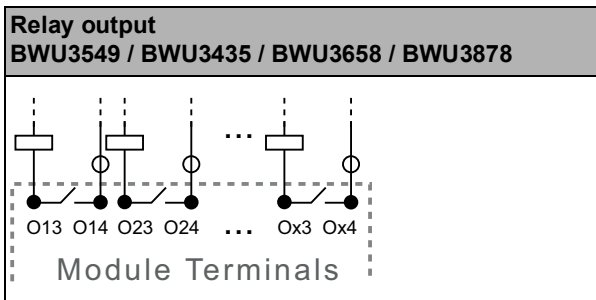
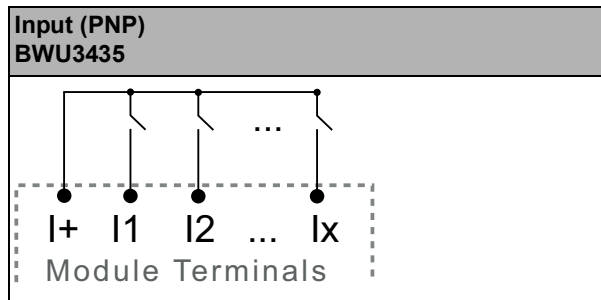



SCATTERGOOD & JOHNSON LTD

ELECTRICAL ENGINEERING & FLUID CONTROL DISTRIBUTORS

Est.1899

At Scattergood & Johnson Ltd, we pride ourselves on being a technical distributor to specialist industries.

Working with a range of quality product suppliers across a number of specialist markets, we are not your average 'box shifter' - we are your technical and supply chain partner.

We fully support every product we sell - for free! Our internal team and external sales engineers can answer any product or application question, no matter the complexity.

Backing up this technical ability is a range of 50,000+ products available from stock for nationwide next day delivery (same day if required!), or you can collect what you need from any of our trade counters around the UK.

Select your specialist interest below to learn more about how we can help.



Online, In Branch and On the Road - Scattergood & Johnson Ltd, there when you need us.

www.scatts.co.uk