

Digital Modules ASi, IP67, M12



2 x 2 connectors for profile cable

2 color LEDs per output, state (yellow), overload (red) (optional)



(Figure similar)



Figure	Type	Inputs digital	Outputs digital	M12 connection (1)	Input voltage (sensor supply) (2)	Output voltage (actuator supply) (3)	ASi connection (4)	ASi address (5)	Max. output current	Art. no.
	IP67, 4 x M12	2	2 x electronic	Y	out of ASi	out of AUX	ASi profile cable	1 AB slave	1 A per output	BWU3456
	IP67, 4 x M12	2	2 x electronic, special ASi bit assignment	Y	out of ASi	out of AUX	ASi profile cable	1 AB slave	1 A per output	BWU3539
	IP67, 4 x M12	2	2 x electronic, special ASi bit assignment	Y	out of ASi	out of AUX	ASi profile cable	1 single slave	1 A per output	BWU3775
	IP67, 4 x M12	2	2 x electronic	single	out of ASi	out of AUX	ASi profile cable	1 AB slave	1 A per output	BWU3141
	IP67, 4 x M12	2	2 x electronic	single	out of ASi	out of AUX	ASi via M12	1 AB slave	1 A per output	BWU3517
	IP67, 4 x M12	4	–	Y	out of ASi	–	ASi profile cable	1 AB slave	–	BWU2552
	IP67, 4 x M12	4	–	Y	out of ASi	–	ASi via M12	1 AB slave	–	BWU3077
	IP67, 4 x M12	4	–	single	out of ASi	–	ASi profile cable	1 AB slave	–	BWU2620
	IP67, 4 x M12	4	–	single	out of ASi	–	ASi profile cable	1 AB slave S-0.A.7.0	–	BWU3556
	IP67, 4 x M12	4	–	single	out of ASi	–	ASi via M12	1 AB slave	–	BWU3457
	IP67, 4 x M12	4	–	single	out of AUX	–	ASi profile cable	1 AB slave	–	BWU2725
	IP67, 4 x M12	4	2 x electronic	mixed	out of AUX	out of AUX	ASi profile cable	1 AB slave	1 A per output	BWU2767
	IP67, 4 x M12	4	4 x electronic	mixed	out of ASi	out of ASi	ASi profile cable	1 AB slave	120 mA per output	BWU3240
	IP67, 4 x M12	4	4 x electronic	mixed	out of AUX	out of AUX	ASi profile cable	1 AB slave	500 mA per output	BWU2547
	IP67, 4 x M12	4	4 x electronic	mixed (inputs/outputs swapped)	out of AUX	out of AUX	ASi profile cable	1 AB slave	500 mA per output	BWU3887
	IP67, 4 x M12	4	4 x electronic	Y	out of ASi	out of AUX	ASi profile cable	1 AB slave	500 mA per output	BWU2487
	IP67, 4 x M12	4	4 x electronic	Y	out of AUX	out of AUX	ASi profile cable	1 AB slave	500 mA per output	BWU3032
	IP67, 4 x M12	4	3 x electronic	Y	out of ASi	out of AUX	ASi profile cable	1 AB slave	500 mA per output	BWU3375
	IP67, 4 x M12	–	4 x electronic	Y	–	out of AUX	ASi profile cable	1 single slave	1 A per output	BWU2713
	IP67, 4 x M12	–	4 x electronic	Y	–	out of AUX	ASi profile cable	1 AB slave	1 A per output	BWU2594
	IP67, 4 x M12	–	4 x electronic	Y	–	out of AUX, 2A per output	ASi profile cable	1 AB slave	2 A per output	BWU2728

Digital Modules ASi, IP67, M12



Figure	Type	Inputs digital	Outputs digital	M12 connection ⁽¹⁾	Input voltage (sensor supply) ⁽²⁾	Output voltage (actuator supply) ⁽³⁾	ASi connection ⁽⁴⁾	ASi address ⁽⁵⁾	Max. output current	Art. no.
	IP67, 8 x M12	4	4 x electronic	Y	out of ASi	out of AUX	ASi profile cable	1 AB slave	1 A per output	BWU2626
	IP67, 8 x M12	4	4 x electronic	Y	out of ASi	out of AUX	ASi profile cable	1 AB slave	2 A per output	BWU3426
	IP67, 8 x M12	4	4 x electronic	single	out of ASi	out of AUX	ASi profile cable	1 AB slave	1 A per output	BWU2617
	IP67, 8 x M12	4	4 x electronic	single	out of ASi	out of AUX	ASi profile cable	1 single slave	1 A per output	BWU2684
	IP67, 8 x M12	4	4 x electronic	single	out of AUX	out of AUX	ASi profile cable	1 AB slave	1 A per output	BWU2810
	IP67, 8 x M12	4	4 x electronic	Y	out of AUX	out of AUX	ASi profile cable	1 AB slave	1 A per output	BWU3510
	IP67, 8 x M12	4	4 x electronic	single	out of AUX	out of AUX	ASi using M12	1 AB slave	1 A per output	BWU2645
	IP67, 8 x M12	4	4 x electronic	single	out of ASi	out of AUX, 2A per output	ASi profile cable	1 single slave	2 A per output	BWU3540
	IP67, 8 x M12	4	3 x electronic	single	out of ASi	out of AUX, 2A per output	ASi profile cable	1 AB slave	2 A per output	BWU3496
	IP67, 8 x M12	8	–	Y	out of AUX	–	ASi profile cable	2 AB slaves	–	BWU2770
	IP67, 8 x M12	8	–	Y	out of ASi	–	ASi profile cable	2 AB slaves	–	BWU2651
	IP67, 8 x M12	8	–	single	out of ASi	–	ASi profile cable	2 AB slaves	–	BWU2983
	IP67, 8 x M12	8	8 x electronic	Y	out of ASi	out of AUX	ASi profile cable	2 AB slaves	1 A per output	BWU2619
	IP67, 8 x M12	8	8 x electronic	Y	out of AUX	out of AUX	ASi profile cable	2 AB slaves	1 A per output	BWU3892
	IP67, 8 x M12	–	8 x electronic	Y	–	–	ASi profile cable	2 AB slaves	1 A per output	BWU2652

Replacement, ASi Version 2: single slaves (digital) are also working with the first generation ASi masters.

(1) **M12 wiring:** either as a single-wiring, Y-wiring or mixed-wiring.

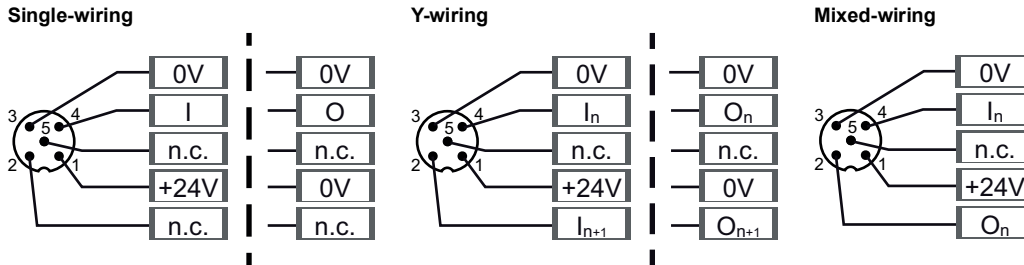

- (2) **Input voltage (sensor supply):** inputs are supplied by ASi or by AUX (auxiliary 24 V power). If supplied by ASi, inputs shall not be connected to earth or to external potential.
- (3) **Output voltage (actuator supply):** outputs are supplied by ASi or by AUX (auxiliary 24 V power). If supplied by ASi, outputs shall not be connected to earth or to external potential
- (4) **ASi connection:** the connection to ASi as well to AUX (auxiliary 24 V power) is made via yellow resp. black ASi profile cable with piercing technology or via M12 socket (in IP20 via clamps).
- (5) **ASi address:** 1 AB Slave (max. 62 AB Slaves/ASi network), 2 AB Slaves (max. 31 modules with 2 AB Slaves), Single Slaves (max. 31 Single Slaves/ASi network), mixed use allowed.
For modules with two slaves the second slave is turned off as long as the first slave is addressed to address "0".
Upon request, slaves are available with specific ASi Slave profiles.

Digital Modules ASi, IP67, M12



Article No.	BWU3077	BWU2552	BWU2620	BWU3556	BWU3457	BWU2725	
General data							
Device type	input						
Connection							
ASi/AUX connection	M12 ⁽¹⁾	profile cable and piercing			M12 ⁽¹⁾	profile cable and piercing	
Periphery connection	M12, Y-wiring		M12, single-wiring				
Length of connector cable	unlimited ⁽²⁾						
ASi							
Profile	S-0.A.E (ID1=7 default)		S-0.A.0 (ID1=7 default)	S-0.A.E (ID1=7 default)	S-0.A.E (ID1=7 default)		
Address	1 AB slave						
Required Master profile	≥M3						
As of ASi specification	2.1						
Operating voltage	30 V (18 ... 31.6 V)						
Max. current consumption	165 mA				45 mA		
Max. current consumption without sensor/ actuator supply	45 mA						
AUX							
Operating voltage	-				24 V (18 ... 30 V)		
Max. current consumption	-				1 A		
Input							
Number	4						
Power supply	out of ASi				out of AUX		
Sensor supply	short-circuit and overload protected according to EN 61131-2						
Power supply of attached sensors	up to +40 °C	120 mA ⁽³⁾				max. 1 A	
	at +55 °C	100 mA ⁽³⁾					
	at +70 °C	80 mA ⁽³⁾					
Switching threshold	U<5 V (low) U>15 V (high)						
Display							
LED ASi (green)	on: ASi voltage on flashing: ASi voltage on, but peripheral fault ⁽⁴⁾ or address 0 off: no ASi voltage						
LED FLT/FAULT (red)	on: slave address 0 or slave offline flashing: peripheral fault ⁽⁴⁾ off: slave online						
LED AUX (green)	-				on: 24 V _{DC} AUX off: no 24 V _{DC} AUX		
LEDs I1 ... In (yellow)	state of inputs I1 ... I4						

Digital Modules ASi, IP67, M12



Article No.	BWU3077	BWU2552	BWU2620	BWU3556	BWU3457	BWU2725
Environment						
Applied standards	EN 61000-6-2 EN 61000-6-3 EN 61131-2 EN 60529					
Can be used in passively safe paths up to SIL3/PLe	yes ⁽⁵⁾					yes ⁽⁹⁾
Operating altitude	max. 2000 m					
Ambient temperature	-30 °C ... +55 °C (up to max. +70 °C) ^{(3) (6)}					
Storage temperature	-25 °C ... +85 °C					
Housing	plastic, for screw mounting	plastic, for DIN rail mounting or for screw mounting ⁽⁸⁾			plastic, for screw mounting	plastic, for DIN rail mounting or for screw mounting ⁽⁸⁾
Pollution degree	2					
Protection category	IP67 ⁽⁷⁾					
Tolerable loading referring to humidity	according to EN 61131-2					
Max. tolerable shock load	30g, 11 ms, acc. EN 61131-2					
Max. tolerable vibration stress	5 ... 8 Hz 50 mm _{pp} /8 ... 500 Hz 6g, acc. EN 61131-2					
Insulation voltage	≥500 V					
Weight	100 g					
Dimensions (W / H / D) in mm	45 / 116,5 / 47,5	45 / 80 / 42			45 / 116,5 / 47,5	45 / 80 / 42

(1) Line protection:

If the module is supplied via a M12 connection with A or B coding, it may only be used with a current load of max. 4 A per pin in acc. with IEC 61076-2-101 and IEC 61076-2-109. A fused tap is recommended. There is no such limitation for modules supplied via piercing contacts.

Connection to ASi and AUX via M12

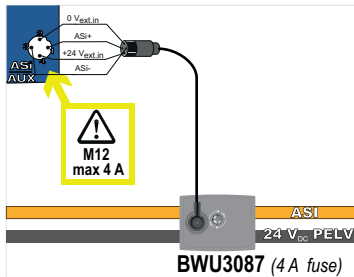

via piercing contacts

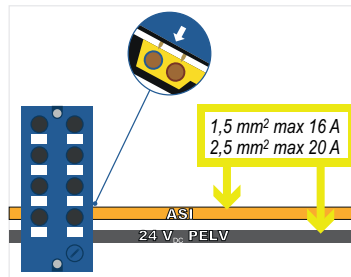

(2) Loop resistance ≤150 Ω

(3) BWU2552, BWU2620, BWU3077, BWU3457, BWU3556 Derating power supply of attached sensors

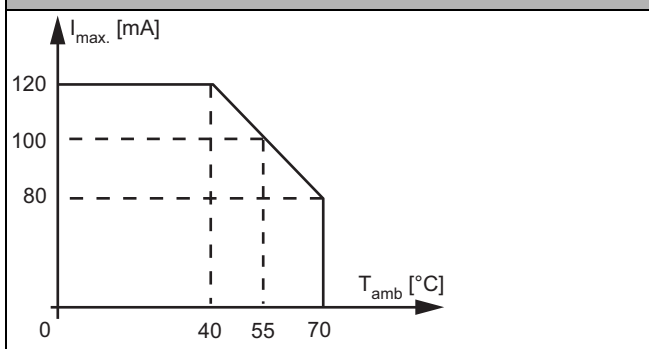

(4) See table "Peripheral fault indication"

(5) The module is suitable for use in passively safe paths as it has no connection to an AUX potential.

Digital Modules ASi, IP67, M12



- (6) Maximum ambient operating temperature +55 °C according UL certificate for the use in the USA and Canada
- (7) Protection category IP67 can only be achieved if all open connections are sealed with suitable end caps fulfilling the same protection category.
- (8) Depending on substructure module (see accessories). The substructure module is not included in the scope of delivery.
- (9) BWU2725 from Ident. No. 18225; the module is suitable for use in passively safe paths because an exclusion of errors can be assumed for the connection of the two potentials, ASi and AUX.

Article No.	BWU2770		BWU2651	BWU2983
General data				
Device type	input			
Connection				
ASi/AUX connection	profile cable and piercing			
Periphery connection	M12, Y-wiring		M12, single-wiring	
Length of connector cable	unlimited ⁽¹⁾			
ASi				
Profile	slave 1: S-0.A.E (ID1=7 default), slave 2: S-0.A.E (ID1=6 default)			
Address	2 AB slaves			
Required Master profile	≥M3			
As of ASi specification	2.1			
Operating voltage	30 V (18 ... 31.6 V)			
Max. current consumption	60 mA	270 mA		
Max. current consumption without sensor/ actuator supply	60 mA	70 mA		
AUX				
Operating voltage	24 V (18 ... 30 V)	–		
Max. current consumption	3 A	–		
Input				
Number	4			
Power supply	out of AUX		out of ASi	
Sensor supply	short-circuit and overload protected according to EN 61131-2			
Power supply of attached sensors	up to +40 °C	max. 1 A	200 mA ⁽⁶⁾	
	at +55 °C		150 mA ⁽³⁾	
	at +70 °C		100 mA ⁽³⁾	
Switching threshold	U < 5 V (low) U > 15 V (high)			
Display				
LED ASI/FLT 1 (red/green)	green: slave online red: slave offline yellow/red flashing: address 0 red/green flashing: peripheral fault ⁽²⁾			
LED ASI/FLT 2 (red/green)	green: slave online red: slave offline yellow/red flashing: address 0 red/green flashing: peripheral fault ⁽⁴⁾ red flashing: slave 2 is switched off, because slave 1 is offline			
LED AUX (green)	on: 24 V _{DC} AUX off: no 24 V _{DC} AUX		–	
LEDs I1 ... I8 (yellow)	state of inputs I1 ... I8			

Digital Modules ASi, IP67, M12



Article No.	BWU2770	BWU2651	BWU2983
Environment			
Applied standards	EN 61000-6-2 EN 61000-6-3 EN 61131-2 EN 60529		
Can be used in passively safe paths up to SIL3/PLe	no ⁽³⁾	yes ⁽⁷⁾	
Operating altitude	max. 2000 m		
Ambient temperature	-30 °C ... +55 °C (up to max. +70 °C) ^{(4) (6)}		
Storage temperature	-25 °C ... +85 °C		
Housing	plastic, for screw mounting		
Pollution degree	2		
Protection category	IP67 ⁽⁵⁾		
Tolerable loading referring to humidity	according to EN 61131-2		
Max. tolerable shock load	30g, 11 ms, acc. EN 61131-2		
Max. tolerable vibration stress	5 ... 8 Hz 50 mm _{pp} /8 ... 500 Hz 6g, acc. EN 61131-2		
Insulation voltage	≥500 V		
Weight	200 g		
Dimensions (W / H / D) in mm	60 / 151 / 31		

(1) Loop resistance ≤150 Ω

(2) **See table "Peripheral fault indication"**

(3) The module is not suitable for use in passively safe paths because an exclusion of errors cannot be assumed for the connection of the two potentials, ASi and AUX.

(4) Maximum ambient operating temperature +55 °C according UL certificate for the use in the USA and Canada

(5) Protection category IP67 can only be achieved if all open connections are sealed with suitable end caps fulfilling the same protection category.

(6)

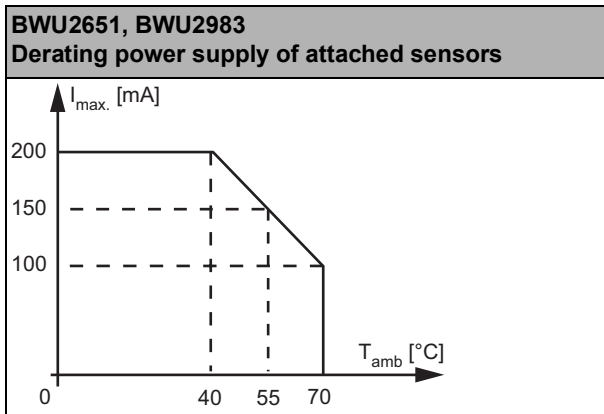

(7) The module is suitable for use in passively safe paths as it has no connection to an AUX potential.

Digital Modules ASi, IP67, M12



Article No.	BWU3775	BWU3539	BWU3456	BWU3141
General data				
Device type	input / output			
Connection				
ASi/AUX Connection	profile cable and piercing			
Periphery connection	M12, Y-wiring			M12, single-wiring
Length of connector cable	unlimited ⁽¹⁾			
ASi				
Profile	S-7.0.E (ID1=F default)	S-7.A.7 (ID1=7 fixed)		
Address	1 single slave	1 AB slave		
Required Master profile	≥M0	≥M4		
As of ASi specification	2.0	3.0		
Operating voltage	30 V (18 ... 31.6 V)			
Max. current consumption	165 mA			
Max. current consumption without sensor/ actuator supply	45 mA			
AUX				
Operating voltage	24 V (18 ... 30 V)			
Max. current consumption	2 A			
Input				
Number	2			
Power supply	out of ASi			
Sensor supply	short-circuit and overload protected according to EN 61131-2			
Power supply of attached sensors	up to +40 °C	120 mA ⁽²⁾		
	at +55 °C	90 mA ⁽²⁾		
	at +70 °C	60 mA ⁽²⁾		
Switching threshold	U < 5 V (low) U > 15 V (high)			
Output				
Number	2			
Power supply	out of AUX			
Output	short-circuit and overload protected according to EN 61131-2			
Max. output current	up to +40 °C	1 A per output, $\sum(\text{Out}) 2 \text{ A}^{(3)}$		
	at +55 °C	1 A per output, $\sum(\text{Out}) 1,5 \text{ A}^{(3)}$		
	at +70 °C	1 A per output, $\sum(\text{Out}) 1 \text{ A}^{(3)}$		
Display				
LED ASi (green)	on: ASi voltage on flashing: ASi voltage on, but peripheral fault ⁽⁴⁾ or address 0 off: no ASi voltage			
LED FLT/FAULT (red)	on: slave address 0 or slave offline flashing: peripheral fault ⁽⁴⁾ off: slave online			
LED AUX (green)	on: 24 V _{DC} AUX off: no 24 V _{DC} AUX			
LEDs I1, I2 (yellow)	state of inputs I1, I2			
LEDs O1 / O2 ... (yellow /red)	–	yellow: state of outputs O1, O2 red: overload		
LEDs O3 / O4 ... (yellow /red)	yellow: state of outputs O3, O4 red: overload	–		

Digital Modules ASi, IP67, M12

Article No.	BWU3775	BWU3539	BWU3456	BWU3141
Environment				
Applied standards	EN 61000-6-2 EN 61000-6-3 EN 61131-2 EN 60529			
Can be used in passively safe paths up to SIL3/PLe	no ⁽⁵⁾		yes ⁽⁹⁾	
Operating altitude	max. 2000 m			
Ambient temperature	-30 °C ... +55 °C ⁽²⁾⁽³⁾⁽⁶⁾ (up to max. +70 °C)			
Storage temperature	-25 °C ... +85 °C			
Housing	plastic, for DIN rail mounting or for screw mounting ⁽⁷⁾			
Pollution degree	2			
Protection category	IP67 ⁽⁸⁾			
Tolerable loading referring to humidity	according to EN 61131-2			
Max. tolerable shock load	30g, 11 ms, acc. EN 61131-2			
Max. tolerable vibration stress	5 ... 8 Hz 50 mm _{pp} /8 ... 500 Hz 6g, acc. EN 61131-2			
Insulation voltage	≥500 V			
Weight	100 g			
Dimensions (W / H / D) in mm	45 / 80 / 42			

(1) Loop resistance ≤150 Ω

(2)

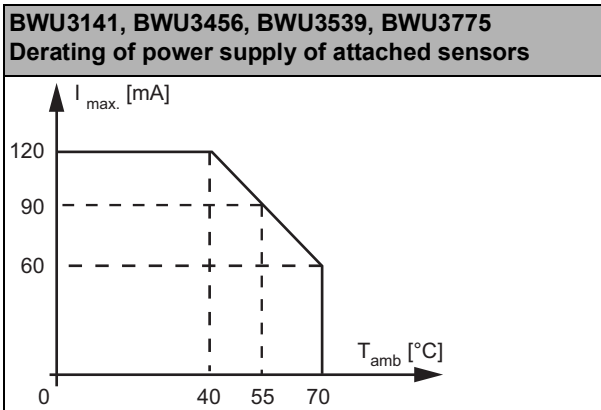

(3)

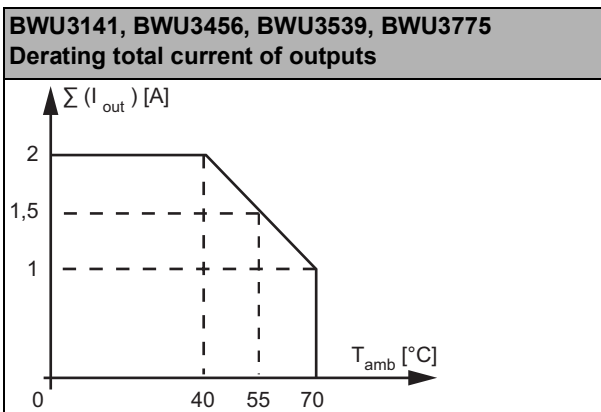

(4) See table "Peripheral fault indication"

(5) The module is not suitable for use in passively safe paths because an exclusion of errors cannot be assumed for the connection of the two potentials, ASi and AUX.

(6) Maximum ambient operating temperature +55 °C according UL certificate for the use in the USA and Canada

(7) Depending on substructure module (see accessories). The substructure module is not included in the scope of delivery.

Digital Modules ASi, IP67, M12



- (8) Protection category IP67 can only be achieved if all open connections are sealed with suitable end caps fulfilling the same protection category.
- (9) BWU3456 from Ident.No. 18209; BWU3141 from Ident. No. 18180; the module is suitable for use in passively safe paths because an exclusion of errors can be assumed for the connection of the two potentials, ASi and AUX.

Article No.	BWU2767		BWU2547		BWU3887		BWU3240	
General data								
Device type	input / output							
Connection								
ASi/AUX Connection	profile cable and piercing							
Periphery connection	M12, mixed- wiring			M12, mixed- wiring (inputs/outputs swapped)		M12, mixed- wiring		
Length of connector cable	unlimited ⁽¹⁾							
ASi								
Profile	S-7.A.E (ID1=7 default)			S-7.A.7 (ID1=7 fixed)				
Address	1 AB slave							
Required Master profile	≥M3			≥M4				
As of ASi specification	3.0							
Operating voltage	30 V (18 ... 31.6 V)							
Max. current consumption	35 mA			165 mA				
Max. current consumption without sensor/ actuator supply	35 mA			45 mA				
AUX								
Operating voltage	24 V (18 ... 30 V)			-				
Max. current consumption	3 A			-				
Input								
Number	4							
Power supply	out of AUX			out of ASi				
Sensor supply	short-circuit and overload protected according to EN 61131-2							
Power supply of attached sensors	up to +40 °C	max. 1 A					∑ (In/Out) max. 120 mA ⁽¹²⁾	
	at +55 °C						∑ (In/Out) 90 mA ⁽¹²⁾	
	at +70 °C						∑ (In/Out) 60 mA ⁽¹²⁾	
Switching threshold	U<5 V (low) U>15 V (high)							
Output								
Number	2			4				
Power supply	out of AUX			out of ASi				
Output	short-circuit and overload protected according to EN 61131-2							
Max. output current	up to +40 °C	1 A per output ∑(Out) 2 A		500 mA per output ∑(Out) 2 A ⁽⁹⁾			∑ (In/Out) 120 mA ⁽¹²⁾	
	at +55 °C			500 mA per output ∑(Out) 1,5 A ⁽⁹⁾			∑ (In/Out) 90 mA ⁽¹²⁾	
	at +70 °C			500 mA per output ∑(Out) 1 A ⁽⁹⁾			∑ (In/Out) 60 mA ⁽¹²⁾	
Display								
LED ASi (green)	on: ASi voltage on flashing: ASi voltage on, but peripheral fault ⁽²⁾ or address 0 off: no ASi voltage							
LED FLT/FAULT (red)	on: slave address 0 or slave offline flashing: peripheral fault ⁽²⁾ off: slave online							
LED AUX (green)	on: 24 V _{DC} AUX off: no 24 V _{DC} AUX			-				
LEDs I1 / O1 ... In / On (yellow)	state of inputs/outputs I1 / O1 ... I4 / O4 input or output is on ⁽³⁾							

Digital Modules ASi, IP67, M12



Article No.	BWU2767	BWU2547	BWU3887	BWU3240
Environment				
Applied standards	EN 61000-6-2 EN 61000-6-3 EN 61131-2 EN 60529			
Can be used in passively safe paths up to SIL3/PLe	yes ⁽⁴⁾	yes ⁽¹⁰⁾	yes ⁽¹¹⁾	yes ⁽¹³⁾
Operating altitude	max. 2000 m			
Ambient temperature	-30 °C ... +55 °C ⁽⁵⁾ ⁽⁶⁾ ⁽⁹⁾ ⁽¹²⁾ (up to max. +70 °C)			
Storage temperature	-25 °C ... +85 °C			
Housing	plastic, for DIN rail mounting or for screw mounting ⁽⁷⁾			
Pollution degree	2			
Protection category	IP67 ⁽⁸⁾			
Tolerable loading referring to humidity	according to EN 61131-2			
Max. tolerable shock load	30g, 11 ms, acc. EN 61131-2			
Max. tolerable vibration stress	5 ... 8 Hz 50 mm _{pp} /8 ... 500 Hz 6g, acc. EN 61131-2			
Insulation voltage	≥500 V			
Weight	100 g			
Dimensions (W / H / D) in mm	45 / 80 / 42			

- (1) Loop resistance ≤150 Ω
- (2) **See table "Peripheral fault indication"**
- (3) **BWU2767:** LEDs I3/O3 and I4/O4 are indicating only the state of inputs I3 and I4 in accordance with the factual input/output assignment.
- (4) BWU2767 from ID no. 18851; The module is suitable for use in passively safe paths because an exclusion of errors can be assumed for the connection of the two potentials, ASi and AUX.
- (5) Temperature range up to -30°C from Ident.No. ≥16388 (BWU2767).
- (6) Maximum ambient operating temperature +55 °C according UL certificate for the use in the USA and Canada
- (7) Depending on substructure module (see accessories). The substructure module is not included in the scope of delivery.
- (8) Protection category IP67 can only be achieved if all open connections are sealed with suitable end caps fulfilling the same protection category.

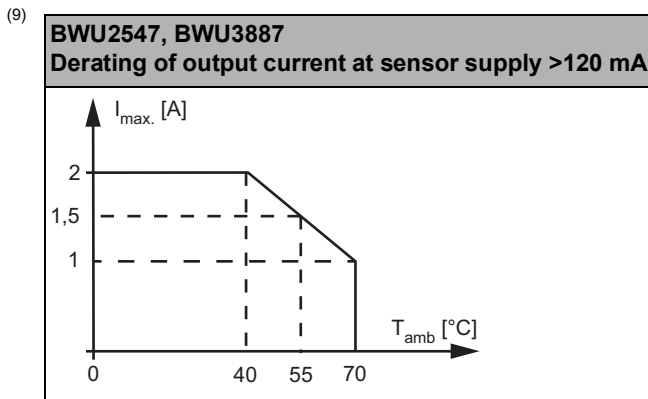

- (10) BWU2547 from Ident. No. 18173; the module is suitable for use in passively safe paths because an exclusion of errors can be assumed for the connection of the two potentials, ASi and AUX.
- (11) BWU3887 from Ident. No. 18303; the module is suitable for use in passively safe paths because an exclusion of errors can be assumed for the connection of the two potentials, ASi and AUX.

Digital Modules ASi, IP67, M12

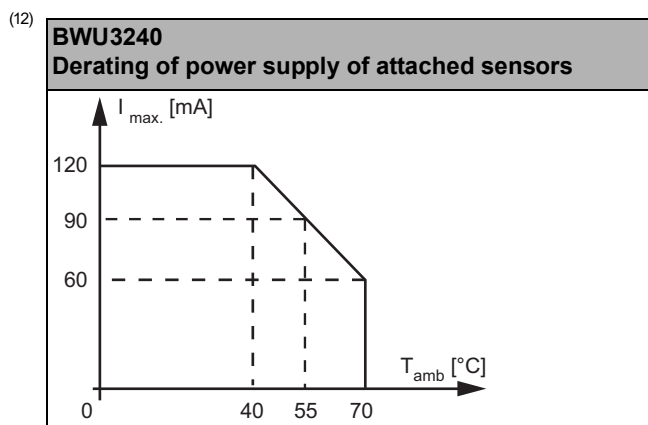

(13) The module is suitable for use in passively safe paths as it has no connection to an AUX potential.

Article No.	BWU2487	BWU3032	BWU3375	BWU3517	
General data					
Device type	input / output				
Connection					
ASi/AUX Connection	profile cable and piercing			M12 ⁽⁹⁾	
Periphery connection	M12, Y-wiring			M12, single wiring	
Length of connector cable	unlimited ⁽¹⁾				
ASi					
Profile	S-7.A.7 (ID1=7 fixed)		S-7.A.0 (ID1=7 default)	S-7.A.7 (ID1=7 fixed)	
Address	1 AB slave				
Required Master profile	≥M4		≥M3	≥M4	
As of ASi specification	3.0		2.1	3.0	
Operating voltage	30 V (18 ... 31.6 V)				
Max. current consumption	165 mA	45 mA	165 mA		
Max. current consumption without sensor/ actuator supply	45 mA				
AUX					
Operating voltage	24 V (18 ... 30 V)				
Max. current consumption	2 A				
Input					
Number	4			2	
Power supply	out of ASi	out of AUX	out of ASi		
Sensor supply	short-circuit and overload protected according to EN 61131-2				
Power supply of attached sensors	up to +40 °C	120 mA ⁽²⁾	1 A	120 mA ⁽²⁾	120 mA ⁽¹⁰⁾
	at +55 °C	90 mA ⁽²⁾		90 mA ⁽²⁾	90 mA ⁽¹⁰⁾
	at +70 °C	60 mA ⁽²⁾		60 mA ⁽²⁾	60 mA ⁽¹⁰⁾
Switching threshold	U < 5 V (low) U > 15 V (high)				
Output					
Number	4		3	2	
Power supply	out of AUX				
Output	short-circuit and overload protected according to EN 61131-2				
Max. output current	up to +40 °C	500 mA per output			1 A per output, Σ(Out) 2 A ⁽¹¹⁾
	at +55 °C				1 A per output, Σ(Out) 1,5 A ⁽¹¹⁾
	at +70 °C				1 A per output, Σ(Out) 1 A ⁽¹¹⁾

Digital Modules ASi, IP67, M12



Article No.	BWU2487	BWU3032	BWU3375	BWU3517
Display				
LED ASi (green)	on: ASi voltage on flashing: ASi voltage on, but peripheral fault ⁽³⁾ or address 0 off: no ASi voltage			
LED FLT/FAULT (red)	on: slave address 0 or slave offline flashing: peripheral fault ⁽⁴⁾ off: slave online			
LED AUX (green)	on: 24 V _{DC} AUX off: no 24 V _{DC} AUX			
LEDs I1 / I2 ... In/In+1 (yellow)	state of inputs I1 / I2 ... I3 / I4: at least 1 input of input pair is on			state of inputs I1 / I2
LEDs O1/O2 ... On / On+1 (yellow)	state of outputs O1 / O2 ... O3 / O4: at least 1 output of output pair is on	state of outputs O1 / O2 ... O3: at least 1 output of output pair is on	-	
LEDs O1, O2 (yellow / red)	-			yellow: state of outputs O1 / O2 red: overload
Environment				
Applied standards	EN 61000-6-2 EN 61000-6-3 EN 61131-2 EN 60529			
Can be used in passively safe paths up to SIL3/PLe	yes ⁽⁴⁾			no ⁽¹²⁾
Operating altitude	max. 2000 m			
Ambient temperature	-30 °C ... +55 °C ^{(2) (5) (6)} (up to max. +70 °C)			-30 °C ... +55 °C (up to max. +70 °C) ^{(10) (11) (6)}
Storage temperature	-25 °C ... +85 °C			
Housing	plastic, for DIN rail mounting or for screw mounting ⁽⁷⁾			
Pollution degree	2			
Protection category	IP67 ⁽⁸⁾			
Tolerable loading referring to humidity	according to EN 61131-2			
Max. tolerable shock load	30g, 11 ms, acc. EN 61131-2			
Max. tolerable vibration stress	5 ... 8 Hz 50 mm _{pp} /8 ... 500 Hz 6g, acc. EN 61131-2			
Insulation voltage	≥500 V			
Weight	100 g			
Dimensions (W / H / D) in mm	45 / 80 / 42			

(1) Loop resistance ≤150 Ω

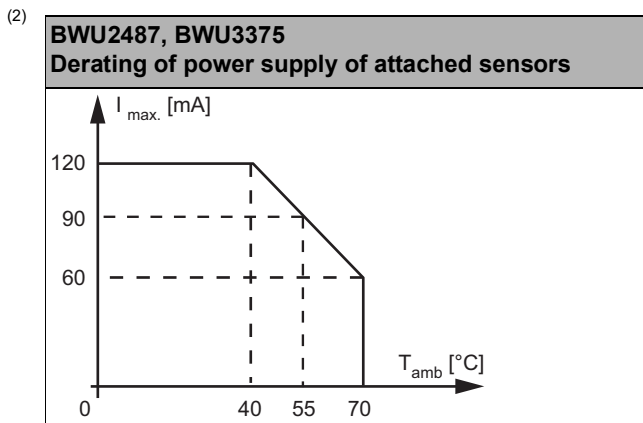

(3) See table "Peripheral fault indication"

(4) BWU2487 from Ident. No. 18369; BWU3032 from Ident. No. 18285; BWU3375 from Ident. No. 18403; the module is suitable for use in passively safe paths because an exclusion of errors can be assumed for the connection of the two potentials, ASi and AUX.

Digital Modules ASi, IP67, M12



- (5) Temperature range up to -30°C from Ident.No. ≥16381 (BWU3032).
- (6) Maximum ambient operating temperature +55 °C according UL certificate for the use in the USA and Canada
- (7) Depending on substructure module (see accessories). The substructure module is not included in the scope of delivery.
- (8) Protection category IP67 can only be achieved if all open connections are sealed with suitable end caps fulfilling the same protection category.
- (9) **Line protection:**
If the module is supplied via a M12 connection with A or B coding, it may only be used with a current load of max. 4 A per pin in acc. with IEC 61076-2-101 and IEC 61076-2-109. A fused tap is recommended. There is no such limitation for modules supplied via piercing contacts.

Connection to ASi and AUX via M12

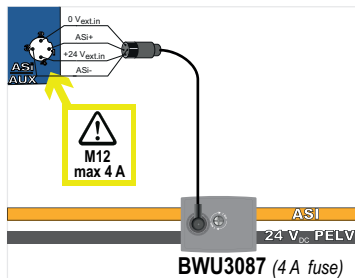

via piercing contacts

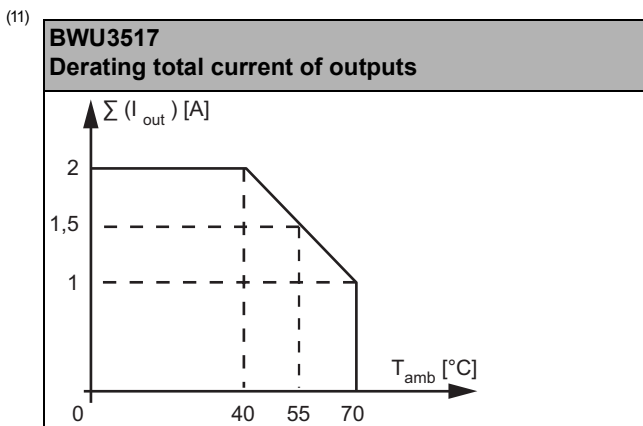
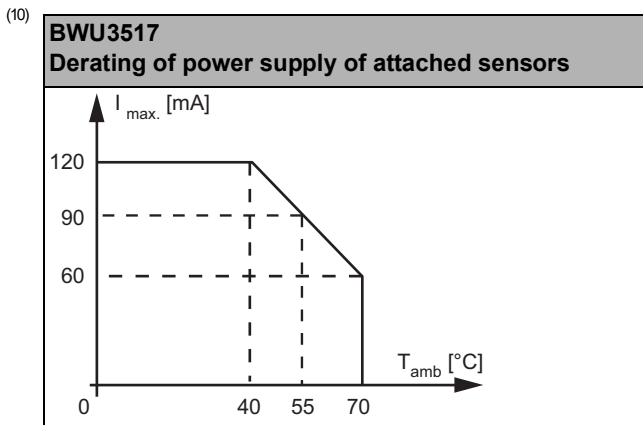
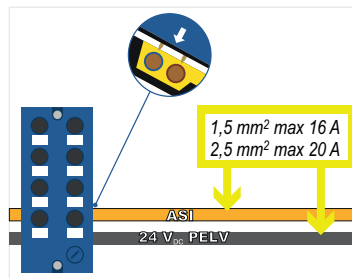

- (12) The module is not suitable for use in passively safe paths because an exclusion of errors cannot be assumed for the connection of the two potentials, ASi and AUX.

Digital Modules ASi, IP67, M12



Article No.	BWU3496	BWU3540	BWU3426	BWU2626	BWU2617	BWU2684
General data						
Device type	input / output					
Connection						
ASi/AUX Connection	profile cable and piercing					
Periphery connection	M12, single-wiring		M12, Y-wiring		M12, single-wiring	
Length of connector cable	unlimited ⁽¹⁾					
ASi						
Profile	S-7.A.0 (ID1=7 default)	S-7.0.E (ID1=F default)	S-7.A.7 (ID1=7 fixed)		S-7.0.E (ID1=F default)	
Address	1 AB slave	1 single slave	1 AB slave		1 single slave	
Required Master profile	≥M3	≥M0	≥M4		≥M0	
As of ASi specification	2.1	2.0	3.0		2.0	
Operating voltage	30 V (18 ... 31.6 V)					
Max. current consumption	165 mA					
Max. current consumption without sensor/ actuator supply	45 mA					
AUX						
Operating voltage	24 V (18 ... 30 V)					
Max. current consumption	6 A	8 A		3 A		
Input						
Number	4					
Power supply	out of ASi					
Sensor supply	short-circuit and overload protected according to EN 61131-2					
Power supply of attached sensors	up to +40 °C	120 mA ⁽²⁾				
	at +55 °C	100 mA ⁽²⁾				
	at +70 °C	80 mA ⁽²⁾				
Switching threshold	U<5 V (low) U>15 V (high)					
Output						
Number	3	4				
Power supply	out of AUX					
Output	short-circuit and overload protected according to EN 61131					
Max. output current	up to +40 °C	2 A per output, Σ (Out) 6 A ⁽³⁾	2 A per output, Σ (Out) 8 A ⁽³⁾		1 A per output, Σ (Out) 3 A ⁽⁸⁾	
	at +55 °C	1,5 A per output, Σ (Out) 4,5 A ⁽³⁾	1,5 A per output, Σ (Out) 6 A ⁽³⁾			
	at +70 °C	1 A per output, Σ (Out) 3 A ⁽³⁾	1 A per output, Σ (Out) 4 A ⁽³⁾		1 A per output, Σ (Out) 2 A ⁽⁸⁾	
Display						
LED ASi (green)	on: ASi voltage on flashing: ASi voltage on, but peripheral fault ⁽⁴⁾ or address 0 off: no ASi voltage					
LED FLT/FAULT (red)	on: slave address 0 or slave offline flashing: peripheral fault ⁽⁴⁾ off: slave online					
LED AUX (green)	on: 24 V _{DC} AUX off: no 24 V _{DC} AUX					
LEDs I1 ... I4 (yellow)	state of inputs I1 ... I4					
LEDs O1 ... O4 (yellow)	state of outputs O1 ... O3	state of outputs O1 ... O4	-			state of outputs O1 ... O4
LEDs O1 ... O4 (yellow / red)	-		yellow: state of outputs O1 ... O4 red: overload			-

Digital Modules ASi, IP67, M12



Article No.	BWU3496	BWU3540	BWU3426	BWU2626	BWU2617	BWU2684
Environment						
Applied standards	EN 61000-6-2 EN 61000-6-3 EN 61131-2 EN 60529					
Can be used in passively safe paths up to SIL3/PLe	yes ⁽⁵⁾					
Operating altitude	max. 2000 m					
Ambient temperature	-30 °C ... +55 °C ⁽²⁾⁽³⁾⁽⁶⁾⁽⁸⁾ (up to max. +70 °C)					
Storage temperature	-30 °C ... +85 °C					
Housing	plastic, for screw mounting					
Pollution degree	2					
Protection category	IP67 ⁽⁷⁾					
Tolerable loading referring to humidity	according to EN 61131-2					
Max. tolerable shock load	30g, 11 ms, acc. EN 61131-2					
Max. tolerable vibration stress	5 ... 8 Hz 50 mm _{pp} /8 ... 500 Hz 6g, acc. EN 61131-2					
Insulation voltage	≥500 V					
Weight	200 g					
Dimensions (W / H / D) in mm	60 / 151 / 31					

(1) Loop resistance ≤150 Ω

(2)

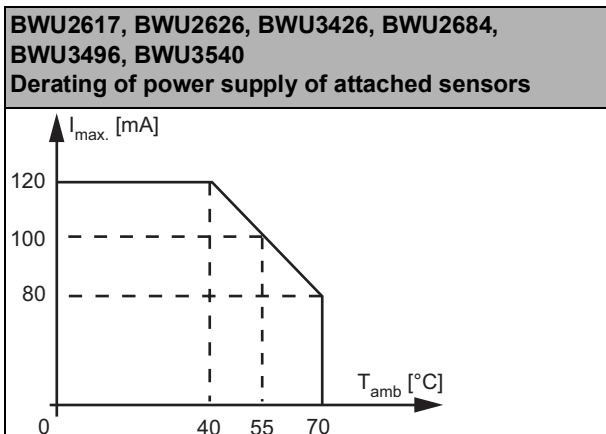

(3)

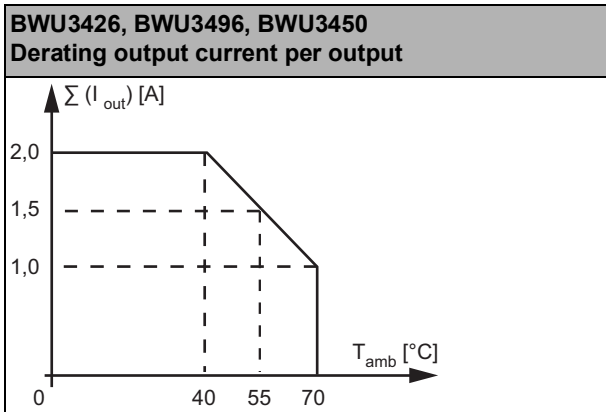

(4) See table "Peripheral fault indication"

(5) BWU3496 from Ident. No. 16960; BWU3540 from Ident. No. 17247; BWU3426 from Ident. No. 17830; BWU2617 from Ident. No. 16955; BWU2684 from Ident. No. 17245; the module is suitable for use in passively safe paths because an exclusion of errors can be assumed for the connection of the two potentials, ASi and AUX.

(6) Maximum ambient operating temperature +55 °C according UL certificate for the use in the USA and Canada

(7) Protection category IP67 can only be achieved if all open connections are sealed with suitable end caps fulfilling the same protection category.

Digital Modules ASi, IP67, M12

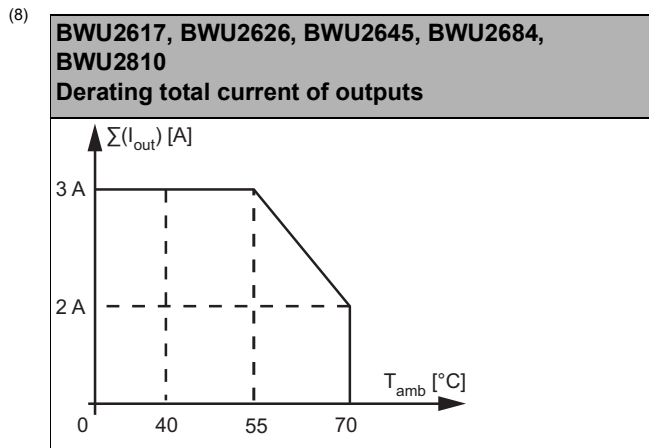

Article No.	BWU3892	BWU2619	BWU2652
General data			
Device type	input / output		output
Connection			
ASi/AUX Connection	profile cable and piercing		
Periphery connection	M12, Y-wiring		
Length of connector cable	unlimited ⁽¹⁾		
ASi			
Profile	slave 1: S-7.A.7 (ID1=7 fixed), slave 2: S-7.A.7 (ID1=6 default)		
Address	2 AB slaves		
Required Master profile	≥M4		
As of ASi specification	3.0		
Operating voltage	30 V (18 ... 31.6 V)		
Max. current consumption	70 mA	270 mA	60 mA
Max. current consumption without sensor/ actuator supply	70 mA		60 mA
AUX			
Operating voltage	24 V (18 ... 30 V)		
Max. current consumption	7 A	6 A	
Input			
Number	8		–
Power supply	out of AUX	out of ASi	–
Sensor supply	short-circuit and overload protected according to EN 61131-2		
Power supply of attached sensors	up to +40 °C	1 A ⁽²⁾	200 mA ⁽⁷⁾
	at +55 °C		150 mA ⁽²⁾
	at +70 °C	0,5 A	100 mA ⁽²⁾
Switching threshold	U<5 V (low) U>15 V (high)		–
Output			
Number	8		
Power supply	out of AUX		
Output	short-circuit and overload protected according to EN 61131-2		
Max. output current	up to +40 °C	1 A per output, Σ(O1...O4) 3 A + Σ (O5-O8) 3 A ⁽³⁾	1 A per output, Σ (O1...O4) 3 A + Σ (O5...O8) 3 A ⁽⁸⁾
	at +55 °C	1 A per output, Σ(O1...O4) 1,625 A + Σ(O5...O8) 1,625 A ⁽³⁾	
	at +70 °C	0,25 A per output, Σ(O1...O4) 0,25 A + Σ(O5...O8) 0,25 A ⁽³⁾	1 A per output, Σ (O1...O4) 2 A + Σ (O5...O8) 2 A ⁽⁸⁾

Digital Modules ASi, IP67, M12



Article No.	BWU3892	BWU2619	BWU2652
Display			
LED ASI/FLT 1 (red/green)	green: slave online red: slave offline yellow/red flashing: address 0 red/green flashing: peripheral fault ⁽⁴⁾		
LED ASI/FLT 2 (red/green)	green: slave online red: slave offline yellow/red flashing: address 0 red/green flashing: peripheral fault ⁽⁴⁾ red flashing: slave 2 is switched off, because slave 1 is offline		
LED AUX (green)	on: 24 V _{DC} AUX off: no 24 V _{DC} AUX		
LEDs I1 / I2 ... In/In+1 (yellow)	state of inputs I1 / I2 ... I7 / I8: at least 1 input of input pair is on	-	
LEDs O1 ... On (yellow / red)	-	yellow: state of outputs O1 ... O8 red: overload	
LEDs O1/O2 ... On / On+1 (yellow)	state of outputs O1 / O2 ... O7 / O8: at least 1 output of output pair is on		-
Environment			
Applied standards	EN 61000-6-2 EN 61000-6-3 EN 61131-2 EN 60529		
Can be used in passively safe paths up to SIL3/PLe	no ⁽⁴⁾	yes ⁽⁹⁾	
Operating altitude	max. 2000 m		
Ambient temperature	-30 °C ... +55 °C ⁽⁷⁾ ⁽³⁾ ⁽⁵⁾ ⁽⁸⁾ (up to max. +70 °C)		
Storage temperature	-30 °C ... +85 °C		
Housing	plastic, for screw mounting		
Pollution degree	2		
Protection category	IP67 ⁽⁶⁾		
Tolerable loading referring to humidity	according to EN 61131-2		
Max. tolerable shock load	30g, 11 ms, acc. EN 61131-2		
Max. tolerable vibration stress	5 ... 8 Hz 50 mm _{pp} /8 ... 500 Hz 6g, acc. EN 61131-2		
Insulation voltage	≥500 V		
Weight	200 g		
Dimensions (W / H / D) in mm	60 / 151 / 31		

(1) Loop resistance ≤150 Ω

(2)

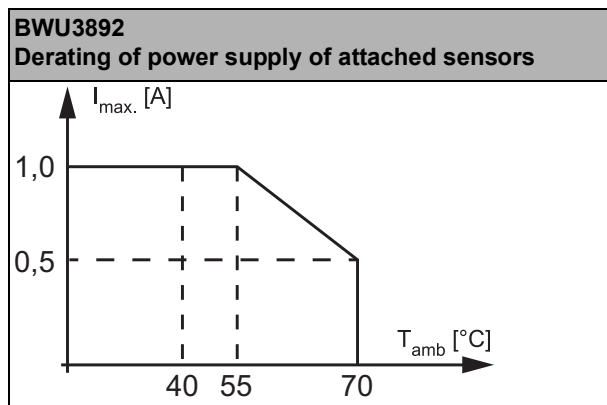

Digital Modules ASi, IP67, M12

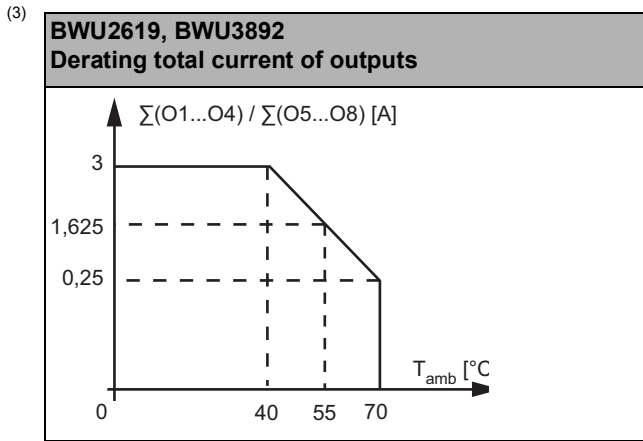

(4) The module is not suitable for use in passively safe paths because an exclusion of errors cannot be assumed for the connection of the two potentials, ASi and AUX.

(5) Maximum ambient operating temperature +55 °C according UL certificate for the use in the USA and Canada

(6) Protection category IP67 can only be achieved if all open connections are sealed with suitable end caps fulfilling the same protection category.

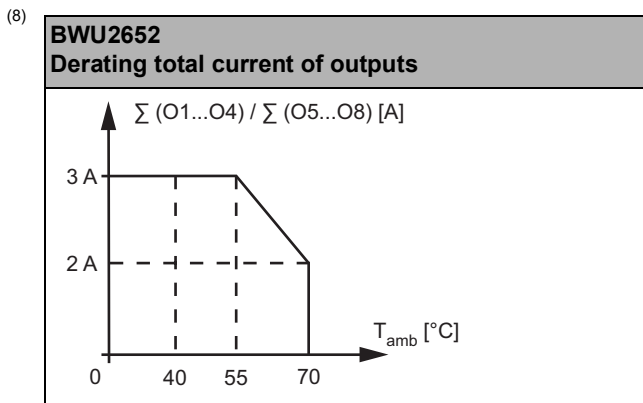
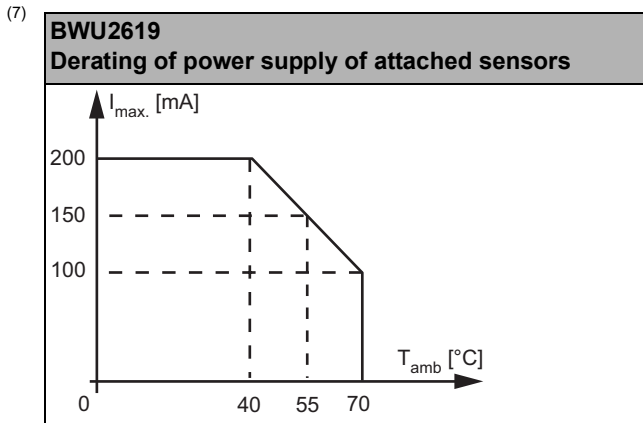

(9) BWU2652 from Ident. No. 18263; The module is suitable for use in passively safe paths because an exclusion of errors can be assumed for the connection of the two potentials, ASi and AUX.

Article No.	BWU3510	BWU2810	BWU2645
General data			
Device type	input / output		
Connection			
ASi/AUX Connection	profile cable and piercing		M12 ⁽⁷⁾
Periphery connection	M12, Y-wiring	M12, single-wiring	
Length of connector cable	unlimited ⁽¹⁾		

Digital Modules ASi, IP67, M12



Article No.	BWU3510	BWU2810	BWU2645
ASi			
Profile	S-7.A.7 (ID1=7 fixed)		
Address	1 AB slave		
Required Master profile	≥M4		
As of ASi specification	3.0		
Operating voltage	30 V (18 ... 31.6 V)		
Max. current consumption	35 mA		
Max. current consumption without sensor/ actuator supply	35 mA		
AUX			
Operating voltage	24 V (18 ... 30 V)		
Max. current consumption	3 A		
Input			
Number	4		
Power supply	out of AUX		
Sensor supply	short-circuit and overload protected according to EN 61131-2		
Power supply of attached sensors	up to +40 °C	max. 1 A	
	at +55 °C		
	at +70 °C		
Switching threshold	U<5 V (low) U>15 V (high)		
Output			
Number	4		
Power supply	out of AUX		
Output	short-circuit and overload protected according to EN 61131		
Max. output current	up to +40 °C	1 A per output, Σ(Out) 3 A ⁽²⁾	
	at +55 °C		
	at +70 °C	1 A per output, Σ(Out) 2 A ⁽³⁾	
Display			
LED ASi (green)	on: ASi voltage on flashing: ASi voltage on, but peripheral fault ⁽³⁾ or address 0 off: no ASi voltage		
LED FLT/FAULT (red)	on: slave address 0 or slave offline flashing: peripheral fault ⁽⁴⁾ off: slave online		
LED AUX (green)	on: 24 V _{DC} AUX off: no 24 V _{DC} AUX		
LEDs I1 ... I4 (yellow)	state of inputs I1 ... I4		
LEDs O1 ... O4 (yellow / red)	yellow: state of outputs O1 ... O4 red: overload		

Digital Modules ASi, IP67, M12

Article No.	BWU3510	BWU2810	BWU2645
Environment			
Applied standards	EN 61000-6-2 EN 61000-6-3 EN 61131-2 EN 60529		
Can be used in passively safe paths up to SIL3/PLe	yes ⁽⁴⁾		
Operating altitude	max. 2000 m		
Ambient temperature	-30 °C ... +55 °C ⁽²⁾⁽⁵⁾ (up to max. +70 °C)		
Storage temperature	-30 °C ... +85 °C		
Housing	plastic, for screw mounting		
Pollution degree	2		
Protection category	IP67 ⁽⁶⁾		
Tolerable loading referring to humidity	according to EN 61131-2		
Max. tolerable shock load	30g, 11 ms, acc. EN 61131-2		
Max. tolerable vibration stress	5 ... 8 Hz 50 mm _{pp} /8 ... 500 Hz 6g, acc. EN 61131-2		
Insulation voltage	≥500 V		
Weight	200 g		
Dimensions (W / H / D) in mm	60 / 151 / 31		

(1) Loop resistance ≤150 Ω

(2)

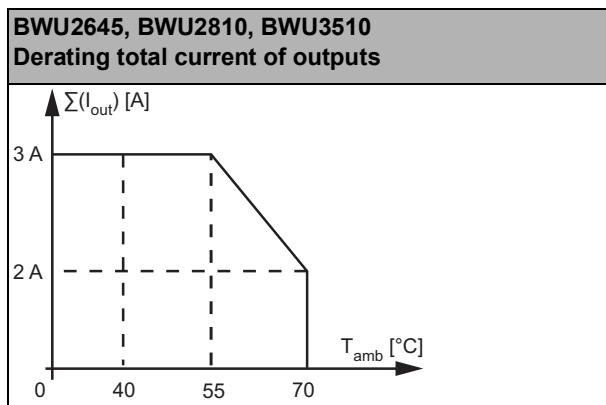

(3) See table "Peripheral fault indication"

(4) BWU3510 from Ident. No. 18000; BWU2810 from Ident. No. 17248; BWU2645 from Ident. No. 17249; the module is suitable for use in passively safe paths because an exclusion of errors can be assumed for the connection of the two potentials, ASi and AUX.

(5) Maximum ambient operating temperature +55 °C according UL certificate for the use in the USA and Canada

(6) Protection category IP67 can only be achieved if all open connections are sealed with suitable end caps fulfilling the same protection category.

Digital Modules ASi, IP67, M12



(7) Line protection:

If the module is supplied via a M12 connection with A or B coding, it may only be used with a current load of max. 4 A per pin in acc. with IEC 61076-2-101 and IEC 61076-2-109. A fused tap is recommended. There is no such limitation for modules supplied via piercing contacts.

Connection to ASi and AUX via M12

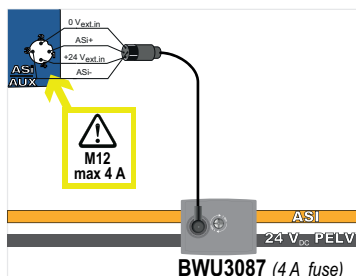

via piercing contacts

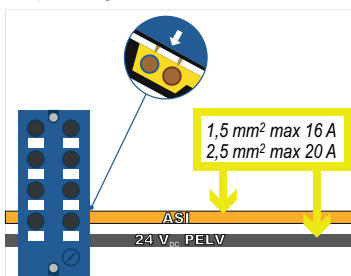

Article No.	BWU2713		BWU2594	BWU2728
General data				
Device type	output			
Connection				
ASi/AUX Connection	profile cable and piercing			
Periphery connection	M12, Y-wiring			
Length of connector cable	unlimited ⁽¹⁾			
ASi				
Profile	S-7.F.E (ID1=F default)		S-7.A.7 (ID1=7 fixed)	
Address	1 single slave		1 AB slave	
Required Master profile	≥M0		≥M4	
As of ASi specification	2		3	
Operating voltage	30 V (18 ... 31.6 V)			
Max. current consumption	35 mA			
Max. current consumption without sensor/ actuator supply	35 mA			
AUX				
Operating voltage	24 V (18 ... 30 V)			
Max. current consumption	3 A		8 A	
Output				
Number	4			
Power supply	out of AUX			
Output	short-circuit and overload protected according to EN 61131			
Max. output current	up to +40 °C	1 A per output Σ (Out) 3 A ⁽²⁾		2 A per output, Σ (Out) 8 A ^{(9) (10)}
	at +55 °C			2 A per output, Σ (Out) 4 A ^{(9) (10)}
	at +70 °C	1 A per output Σ (Out) 2 A ⁽²⁾		–
Display				
LED ASi (green)	on: ASi voltage on flashing: ASi voltage on, but peripheral fault ⁽³⁾ or address 0 off: no ASi voltage			
LED FLT/FAULT (red)	on: slave address 0 or slave offline flashing: peripheral fault ⁽³⁾ off: slave online			
LED AUX (green)	on: 24 V _{DC} AUX off: no 24 V _{DC} AUX			
LEDs O1 ... On (yellow / red)	yellow: state of outputs O1 ... O4 red: overload			

Digital Modules ASi, IP67, M12

Article No.	BWU2713	BWU2594	BWU2728
Environment			
Applied standards	EN 61000-6-2 EN 61000-6-3 EN 61131-2 EN 60529		
Can be used in passively safe paths up to SIL3/PLe	yes ⁽⁴⁾	no ⁽⁸⁾	yes ⁽¹¹⁾
Operating altitude	max. 2000 m		
Ambient temperature	-30 °C ... +55 °C (up to max. +70 °C) ⁽²⁾ ⁽⁵⁾ ⁽⁹⁾		
Storage temperature	-30 °C ... +85 °C		
Housing	plastic, for DIN rail mounting or for screw mounting ⁽⁶⁾		
Pollution degree	2		
Protection category	IP67 ⁽⁷⁾		
Tolerable loading referring to humidity	according to EN 61131-2		
Max. tolerable shock load	30g, 11 ms, acc. EN 61131-2		
Max. tolerable vibration stress	5 ... 8 Hz 50 mm _{pp} /8 ... 500 Hz 6g, acc. EN 61131-2		
Insulation voltage	≥500 V		
Weight	100 g		
Dimensions (W / H / D) in mm	45 / 80 / 42		

(1) Loop resistance ≤150 Ω

(2)

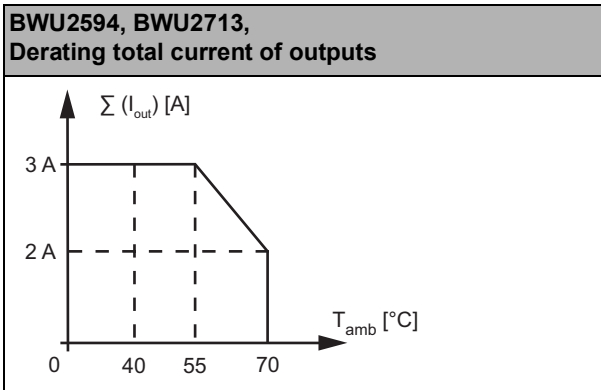

(3) See table "Peripheral fault indication"

(4) BWU2713 from ID no. 18595; The module is suitable for use in passively safe paths because an exclusion of errors can be assumed for the connection of the two potentials, ASi and AUX.

(5) Maximum ambient operating temperature +55 °C according UL certificate for the use in the USA and Canada.

(6) Depending on substructure module (see accessories). The substructure module is not included in the scope of delivery.

(7) Protection category IP67 can only be achieved if all open connections are sealed with suitable end caps fulfilling the same protection category.

(8) The module is not suitable for use in passively safe paths because an exclusion of errors cannot be assumed for the connection of the two potentials, ASi and AUX.

Digital Modules ASi, IP67, M12

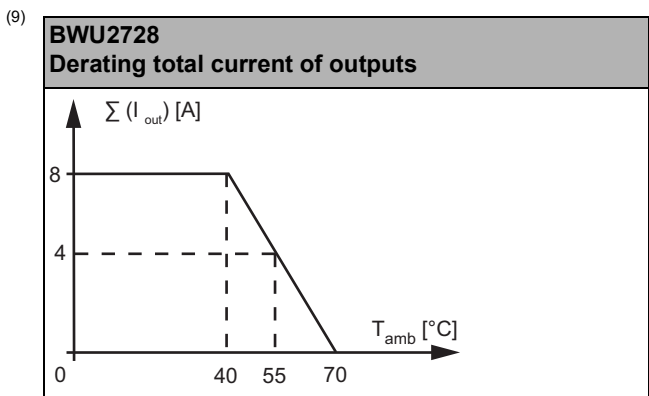

- (10) To power consumers whose current draw is greater than 2A, two or more outputs can be combined with each other. The data bits of the bundled outputs must be set at the same time.
- (11) BWU2728 from Ident. No. 17399; the module is suitable for use in passively safe paths because an exclusion of errors can be assumed for the connection of the two potentials, ASi and AUX.

Dimensional drawings

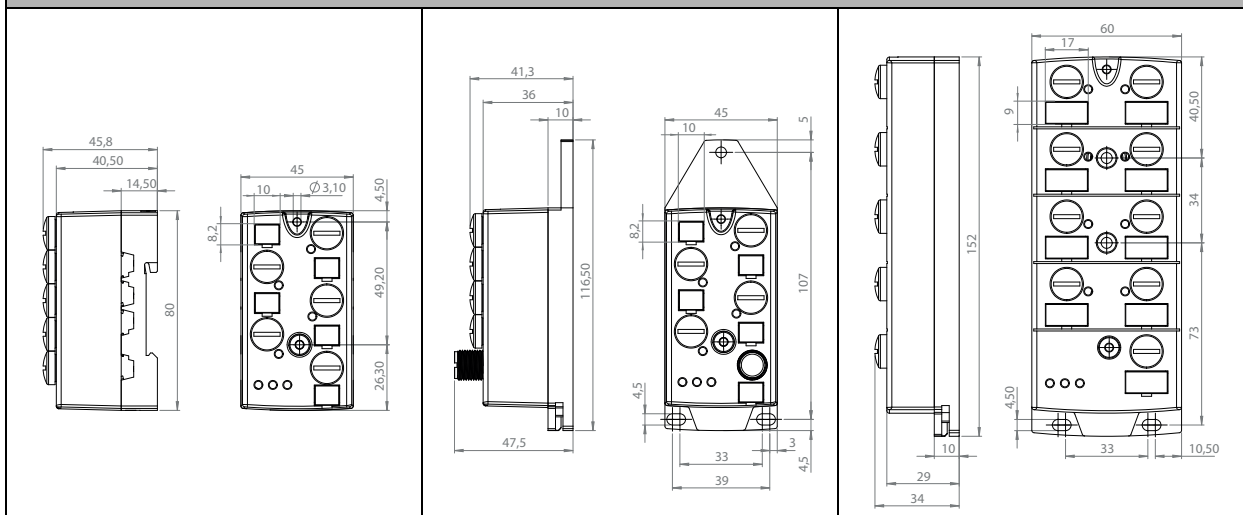

UL-specifications (UL508)

BWU2547, BWU2552, BWU2594, BWU2617, BWU2619, BWU2620, BWU2626, BWU3426, BWU2645, BWU2651, BWU2652, BWU2684, BWU2713, BWU2725, BWU2728, BWU2767, BWU2770, BWU2810, BWU2983, BWU3032, BWU3077, BWU3141, BWU3240, BWU3375, BWU3539, BWU3456, BWU3457, BWU3496, BWU3510, BWU3517, BWU3540, BWU3556, BWU3775, BWU3887, BWU3892

External protection	An isolated source with a secondary open circuit voltage of $\leq 30 V_{DC}$ with a 3 A maximum over current protection. Over current protection is not required when a Class 2 source is employed.
In general	UL mark does not provide UL certification for any functional safety rating or aspects of the above devices.

Digital Modules ASi, IP67, M12



Article no.	Peripheral fault indication		
	Overload sensor supply	Output short circuited	AUX voltage missing
BWU2487	•	–	–
BWU2547	–	–	•
BWU2552	•	–	–
BWU2594	•	•	•
BWU2617	•	•	–
BWU2619	•	•	–
BWU2620	•	–	–
BWU2626	•	•	–
BWU3426	•	–	–
BWU2645	•	•	–
BWU2651	•	–	–
BWU2652	•	•	•
BWU2684	•	•	–
BWU2713	•	•	•
BWU2725	•	–	•
BWU2728	•	•	•
BWU2767	•	–	•
BWU2770	•	–	•
BWU2810	•	•	–
BWU2983	•	–	–
BWU3032	•	–	–
BWU3077	•	–	–
BWU3141	•	•	•
BWU3240	•	–	–
BWU3375	•	–	–
BWU3539	•	•	–
BWU3456	•	•	•
BWU3457	•	–	–
BWU3496	•	–	–
BWU3510	•	•	–
BWU3517	•	•	•
BWU3540	•	–	–
BWU3556	•	–	–
BWU3775	•	•	–
BWU3887	–	–	•
BWU3892	•	•	–

Digital Modules ASi, IP67, M12



Programming	ASi bit assignment			
Bit	D3	D2	D1	D0
	input			
BWU2487 / BWU2547 / BWU2552 / BWU2617 / BWU2620 / BWU2626 / BWU3426 / BWU2645 / BWU2684 / BWU2725 / BWU2767 / BWU2810 / BWU3032 / BWU3077 / BWU3240 / BWU3375 / BWU3496 / BWU3510 / BWU3556 / BWU3540 / BWU3457 / BWU3887	I4	I3	I2	I1
BWU3141 / BWU3456 BWU3539 / BWU3517 / BWU3775	–	–	I2	I1
BWU2619 / BWU2651 / BWU2770 / BWU2983 / BWU3892	slave 1: I4	slave 1: I3	slave 1: I2	slave 1: I1
	slave 2: I8	slave 2: I7	slave 2: I6	slave 2: I5
	output			
BWU2487 / BWU2547 / BWU2594 / BWU2617 / BWU2626 / BWU3426 / BWU2645 / BWU2684 / BWU2713 / BWU2728 / BWU2810 / BWU3032 / BWU3240 / BWU3510 / BWU3540 / BWU3887	O4	O3	O2	O1
BWU2767 / BWU3141 / BWU3456 / BWU3517	–	–	O2	O1
BWU3539 / BWU3775	O4	O3	–	–
BWU3375 / BWU3496	–	O3	O2	O1
BWU2619 / BWU2652 / BWU3892	slave 1: O4	slave 1: O3	slave 1: O2	slave 1: O1
	slave 2: O8	slave 2: O7	slave 2: O6	slave 2: O5

Programming	Parameter bits			
Bit	P3	P2	P1	P0
BWU2652			–	not used, Watchdog always on
BWU2594 / BWU2713			0= off / 1= on (peripheral fault, if AUX missing)	0= off / 1= on (Watchdog)
BWU2728				
BWU2487 / BWU2547 / BWU2617 / BWU2626 / BWU3426 / BWU2645 / BWU2684 / BWU2767 / BWU2810 / BWU3032 / BWU3141 / BWU3240 / BWU3375 / BWU3456 / BWU3539 / BWU3496 / BWU3510 / BWU3517 / BWU3540 / BWU3775 / BWU3887	not used	0= on / 1= off (synchronous I/O mode)	0= on / 1= off (data input filter 128µs)	
BWU2552 / BWU2620 / BWU2651 / BWU2725 / BWU2770 / BWU2983 / BWU3077 / BWU3457 BWU3556				0= off / 1= on (peripheral fault)
BWU2619 / BWU3892				not used, Watchdog always on

Digital Modules ASi, IP67, M12

Pin assignment

Signal name	Explanation
Ix	digital input x
Ox	digital output x
24V _{ext out}	power supply, out of external voltage, positive pole (AUX, actuator supply)
0V _{ext out}	power supply, out of external voltage, negative pole (AUX, actuator supply)
24V _{out of ASi}	power supply, out of ASi, positive pole (sensor supply)
0V _{out of ASi}	power supply, out of ASi, negative pole (sensor supply)
ASi +, ASi -	connection to ASi bus
n.c. (not connected)	not connected

Connections							
Article no.	M12 connection	Marking	Pin1	Pin2	Pin3	Pin4	Pin5
BWU3141	X1	I1	24 V _{out of ASi}	n.c.	0 V _{out of ASi}	I1	n.c.
	X2	O1	24 V _{ext out}	n.c.	0 V _{ext out}	O1	n.c.
	X3	I2	24 V _{out of ASi}	n.c.	0 V _{out of ASi}	I2	n.c.
	X4	O2	24 V _{ext out}	n.c.	0 V _{ext out}	O2	n.c.
	ADDR (dummy plug)	connection for ASi addressing device					
BWU3456	X1	I1	24 V _{out of ASi}	I2	0 V _{out of ASi}	I1	n.c.
	X2	O1	24 V _{ext out}	O2	0 V _{ext out}	O1	n.c.
	X3	I2	24 V _{out of ASi}	n.c.	0 V _{out of ASi}	I2	n.c.
	X4	O2	24 V _{ext out}	n.c.	0 V _{ext out}	O2	n.c.
	ADDR (dummy plug)	connection for ASi addressing device					
BWU3539 BWU3775	X1	I1	24 V _{out of ASi}	I2	0 V _{out of ASi}	I1	n.c.
	X2	O3	24 V _{ext out}	O4	0 V _{ext out}	O3	n.c.
	X3	I2	24 V _{out of ASi}	n.c.	0 V _{out of ASi}	I2	n.c.
	X4	O4	24 V _{ext out}	n.c.	0 V _{ext out}	O4	n.c.
	ADDR (dummy plug)	connection for ASi addressing device					
BWU2487	X1	I1/I2	24 V _{out of ASi}	I2	0 V _{out of ASi}	I1	n.c.
	X2	O1/O2	24 V _{ext out}	O2	0 V _{ext out}	O1	n.c.
	X3	I3/I4	24 V _{out of ASi}	I4	0 V _{out of ASi}	I3	n.c.
	X4	O3/O4	24 V _{ext out}	O4	0 V _{ext out}	O3	n.c.
	ADDR (dummy plug)	connection for ASi addressing device					
BWU3032	X1	I1/I2	24 V _{ext out}	I2	0 V _{ext out}	I1	n.c.
	X2	O1/O2	24 V _{ext out}	O2	0 V _{ext out}	O1	n.c.
	X3	I3/I4	24 V _{ext out}	I4	0 V _{ext out}	I3	n.c.
	X4	O3/O4	24 V _{ext out}	O4	0 V _{ext out}	O3	n.c.
	ADDR (dummy plug)	connection for ASi addressing device					
BWU3375	X1	I1/I2	24 V _{out of ASi}	I2	0 V _{out of ASi}	I1	n.c.
	X2	O1/O2	24 V _{ext out}	O2	0 V _{ext out}	O1	n.c.
	X3	I3/I4	24 V _{out of ASi}	I4	0 V _{out of ASi}	I3	n.c.
	X4	O3	24 V _{ext out}	n.c.	0 V _{ext out}	O3	n.c.
	ADDR (dummy plug)	connection for ASi addressing device					
BWU2547	X1	I1/O1	24 V _{ext out}	O1	0 V _{ext out}	I1	n.c.
	X2	I2/O2	24 V _{ext out}	O2	0 V _{ext out}	I2	n.c.
	X3	I3/O3	24 V _{ext out}	O3	0 V _{ext out}	I3	n.c.
	X4	I4/O4	24 V _{ext out}	O4	0 V _{ext out}	I4	n.c.
	ADDR (dummy plug)	connection for ASi addressing device					

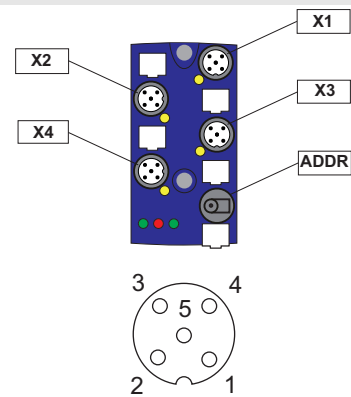

Digital Modules ASi, IP67, M12



Connections							
Article no.	M12 connection	Marking	Pin1	Pin2	Pin3	Pin4	Pin5
BWU3887	X1	I1/O1	24 V _{ext out}	I1	0 V _{ext out}	O1	n.c.
	X2	I2/O2	24 V _{ext out}	I2	0 V _{ext out}	O2	n.c.
	X3	I3/O3	24 V _{ext out}	I3	0 V _{ext out}	O3	n.c.
	X4	I4/O4	24 V _{ext out}	I4	0 V _{ext out}	O4	n.c.
	ADDR (dummy plug)	connection for ASi addressing device					
BWU2767	X1	I1/O1	24 V _{ext out}	O1	0 V _{ext out}	I1	n.c.
	X2	I2/O2	24 V _{ext out}	O2	0 V _{ext out}	I2	n.c.
	X3	I3	24 V _{ext out}	n.c.	0 V _{ext out}	I3	n.c.
	X4	I4	24 V _{ext out}	n.c.	0 V _{ext out}	I4	n.c.
	ADDR (dummy plug)	connection for ASi addressing device					
BWU2594 BWU2713 BWU2728	X1	O1	0 V _{ext out}	O2	0 V _{ext out}	O1	n.c.
	X2	O2	0 V _{ext out}	n.c.	0 V _{ext out}	O2	n.c.
	X3	O3	0 V _{ext out}	O4	0 V _{ext out}	O3	n.c.
	X4	O4	0 V _{ext out}	n.c.	0 V _{ext out}	O4	n.c.
	ADDR (dummy plug)	connection for ASi addressing device					
BWU2552	X1	I1	24 V _{out of ASi}	I2	0 V _{out of ASi}	I1	n.c.
	X2	I2	24 V _{out of ASi}	n.c.	0 V _{out of ASi}	I2	n.c.
	X3	I3	24 V _{out of ASi}	I4	0 V _{out of ASi}	I3	n.c.
	X4	I4	24 V _{out of ASi}	n.c.	0 V _{out of ASi}	I4	n.c.
	ADDR (dummy plug)	connection for ASi addressing device					
BWU2620 BWU3556	X1	I1	24 V _{out of ASi}	n.c.	0 V _{out of ASi}	I1	n.c.
	X2	I2	24 V _{out of ASi}	n.c.	0 V _{out of ASi}	I2	n.c.
	X3	I3	24 V _{out of ASi}	n.c.	0 V _{out of ASi}	I3	n.c.
	X4	I4	24 V _{out of ASi}	n.c.	0 V _{out of ASi}	I4	n.c.
	ADDR (dummy plug)	connection for ASi addressing device					
BWU3457	X1	I1	24 V _{out of ASi}	n.c.	0 V _{out of ASi}	I1	n.c.
	X2	I2	24 V _{out of ASi}	n.c.	0 V _{out of ASi}	I2	n.c.
	X3	I3	24 V _{out of ASi}	n.c.	0 V _{out of ASi}	I3	n.c.
	X4	I4	24 V _{out of ASi}	n.c.	0 V _{out of ASi}	I4	n.c.
	X5	ASi	ASi+	n.c.	ASi-	n.c.	-
BWU2725	X1	I1	24 V _{ext out}	n.c.	0 V _{ext out}	I1	n.c.
	X2	I2	24 V _{ext out}	n.c.	0 V _{ext out}	I2	n.c.
	X3	I3	24 V _{ext out}	n.c.	0 V _{ext out}	I3	n.c.
	X4	I4	24 V _{ext out}	n.c.	0 V _{ext out}	I4	n.c.
	ADDR (dummy plug)	connection for ASi addressing device					
BWU3077	X1	I1	24 V _{out of ASi}	I2	0 V _{out of ASi}	I1	n.c.
	X2	I2	24 V _{out of ASi}	n.c.	0 V _{out of ASi}	I2	n.c.
	X3	I3	24 V _{out of ASi}	I4	0 V _{out of ASi}	I3	n.c.
	X4	I4	24 V _{out of ASi}	n.c.	0 V _{out of ASi}	I4	n.c.
	X5	ASi	ASi+	n.c.	ASi-	n.c.	-

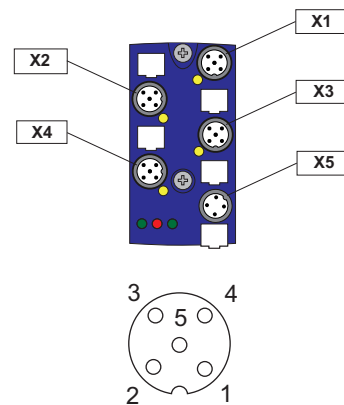
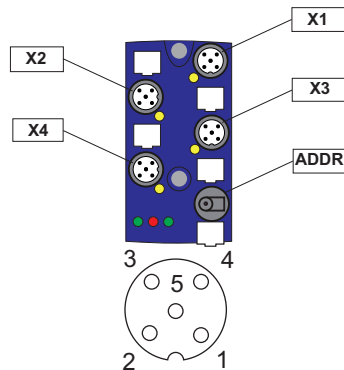

Digital Modules ASi, IP67, M12



Connections							
Article no.	M12 connection	Marking	Pin1	Pin2	Pin3	Pin4	Pin5
BWU3240	X1	I1/O1	24 V _{out} of ASi	O1	0 V _{out} of ASi	I1	n.c.
	X2	I2/O2	24 V _{out} of ASi	O2	0 V _{out} of ASi	I2	n.c.
	X3	I3/O3	24 V _{out} of ASi	O3	0 V _{out} of ASi	I3	n.c.
	X4	I4/O4	24 V _{out} of ASi	O4	0 V _{out} of ASi	I4	n.c.
	ADDR (dummy plug)	connection for ASi addressing device					
BWU3517	X1	I1	24 V _{out} of ASi	n.c.	0 V _{out} of ASi	I1	n.c.
	X2	O1	24 V _{ext} out	n.c.	0 V _{ext} out	O1	n.c.
	X3	I2	24 V _{out} of ASi	n.c.	0 V _{out} of ASi	I2	n.c.
	X4	O2	24 V _{ext} out	n.c.	0 V _{ext} out	O2	n.c.
	X5	ASi	ASi+	0 V _{ext} in	ASi-	24 V _{ext} in	-

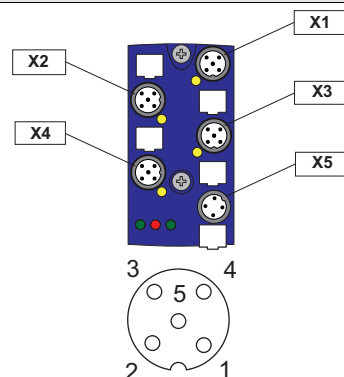

Connections								
Article no.	M12 connection	Marking	Pin1	Pin2	Pin3	Pin4	Pin5	
BWU2617 BWU2684	X1	I1	24 V _{out} of ASi	n.c.	0 V _{out} of ASi	I1	n.c.	
	X2	I2	24 V _{out} of ASi	n.c.	0 V _{out} of ASi	I2	n.c.	
	X3	I3	24 V _{out} of ASi	n.c.	0 V _{out} of ASi	I3	n.c.	
	X4	I4	24 V _{out} of ASi	n.c.	0 V _{out} of ASi	I4	n.c.	
	X5	O1	0 V _{ext} out	n.c.	0 V _{ext} out	O1	n.c.	
	X6	O2	0 V _{ext} out	n.c.	0 V _{ext} out	O2	n.c.	
	X7	O3	0 V _{ext} out	n.c.	0 V _{ext} out	O3	n.c.	
	X8	O4	0 V _{ext} out	n.c.	0 V _{ext} out	O4	n.c.	
	ADDR (dummy plug)	connection for ASi addressing device						
BWU2619	X1	I1/I2	24 V _{out} of ASi	I2	0 V _{out} of ASi	I1	n.c.	
	X2	I3/I4	24 V _{out} of ASi	I4	0 V _{out} of ASi	I3	n.c.	
	X3	I5/I6	24 V _{out} of ASi	I6	0 V _{out} of ASi	I5	n.c.	
	X4	I7/I8	24 V _{out} of ASi	I8	0 V _{out} of ASi	I7	n.c.	
	X5	O1/O2	0 V _{ext} out	O2	0 V _{ext} out	O1	n.c.	
	X6	O3/O4	0 V _{ext} out	O4	0 V _{ext} out	O3	n.c.	
	X7	O5/O6	0 V _{ext} out	O6	0 V _{ext} out	O5	n.c.	
	X8	O7/O8	0 V _{ext} out	O8	0 V _{ext} out	O7	n.c.	
	ADDR (dummy plug)	connection for ASi addressing device						
BWU2626 BWU3426	X1	I1	24 V _{out} of ASi	I2	0 V _{out} of ASi	I1	n.c.	
	X2	I2	24 V _{out} of ASi	n.c.	0 V _{out} of ASi	I2	n.c.	
	X3	I3	24 V _{out} of ASi	I4	0 V _{out} of ASi	I3	n.c.	
	X4	I4	24 V _{out} of ASi	n.c.	0 V _{out} of ASi	I4	n.c.	
	X5	O1	0 V _{ext} out	O2	0 V _{ext} out	O1	n.c.	
	X6	O2	0 V _{ext} out	n.c.	0 V _{ext} out	O2	n.c.	
	X7	O3	0 V _{ext} out	O4	0 V _{ext} out	O3	n.c.	
	X8	O4	0 V _{ext} out	n.c.	0 V _{ext} out	O4	n.c.	
	ADDR (dummy plug)	connection for ASi addressing device						
BWU3496	X1	I1	24 V _{out} of ASi	n.c.	0 V _{out} of ASi	I1	n.c.	
	X2	I2	24 V _{out} of ASi	n.c.	0 V _{out} of ASi	I2	n.c.	
	X3	I3	24 V _{out} of ASi	n.c.	0 V _{out} of ASi	I3	n.c.	
	X4	I4	24 V _{out} of ASi	n.c.	0 V _{out} of ASi	I4	n.c.	
	X5	O1	0 V _{ext} out	n.c.	0 V _{ext} out	O1	n.c.	
	X6	O2	0 V _{ext} out	n.c.	0 V _{ext} out	O2	n.c.	
	X7	O3	0 V _{ext} out	n.c.	0 V _{ext} out	O3	n.c.	
	X8	not used						
	ADDR (dummy plug)	connection for ASi addressing device						

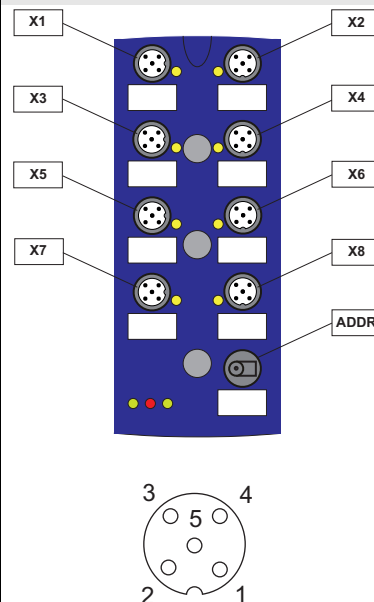

Digital Modules ASi, IP67, M12



Connections							
Article no.	M12 connection	Marking	Pin1	Pin2	Pin3	Pin4	Pin5
BWU3540	X1	I1	24 V _{out of ASi}	n.c.	0 V _{out of ASi}	I1	n.c.
	X2	I2	24 V _{out of ASi}	n.c.	0 V _{out of ASi}	I2	n.c.
	X3	I3	24 V _{out of ASi}	n.c.	0 V _{out of ASi}	I3	n.c.
	X4	I4	24 V _{out of ASi}	n.c.	0 V _{out of ASi}	I4	n.c.
	X5	O1	0 V _{ext out}	n.c.	0 V _{ext out}	O1	n.c.
	X6	O2	0 V _{ext out}	n.c.	0 V _{ext out}	O2	n.c.
	X7	O3	0 V _{ext out}	n.c.	0 V _{ext out}	O3	n.c.
	X8	O4	0 V _{ext out}	n.c.	0 V _{ext out}	O4	n.c.
ADDR (dummy plug)	connection for ASi addressing device						
BWU3892	X1	I1/I2	24 V _{ext out}	I2	0 V _{ext out}	I1	n.c.
	X2	I3/I4	24 V _{ext out}	I4	0 V _{ext out}	I3	n.c.
	X3	I5/I6	24 V _{ext out}	I6	0 V _{ext out}	I5	n.c.
	X4	I7/I8	24 V _{ext out}	I8	0 V _{ext out}	I7	n.c.
	X5	O1/O2	0 V _{ext out}	O2	0 V _{ext out}	O1	n.c.
	X6	O3/O4	0 V _{ext out}	O4	0 V _{ext out}	O3	n.c.
	X7	O5/O6	0 V _{ext out}	O6	0 V _{ext out}	O5	n.c.
	X8	O7/O8	0 V _{ext out}	O8	0 V _{ext out}	O7	n.c.
ADDR (dummy plug)	connection for ASi addressing device						
BWU2651	X1	I1	24 V _{out of ASi}	I2	0 V _{out of ASi}	I1	n.c.
	X2	I2	24 V _{out of ASi}	n.c.	0 V _{out of ASi}	I2	n.c.
	X3	I3	24 V _{out of ASi}	I4	0 V _{out of ASi}	I3	n.c.
	X4	I4	24 V _{out of ASi}	n.c.	0 V _{out of ASi}	I4	n.c.
	X5	I5	24 V _{out of ASi}	I6	0 V _{out of ASi}	I5	n.c.
	X6	I6	24 V _{out of ASi}	n.c.	0 V _{out of ASi}	I6	n.c.
	X7	I7	24 V _{out of ASi}	I8	0 V _{out of ASi}	I7	n.c.
	X8	I8	24 V _{out of ASi}	n.c.	0 V _{out of ASi}	I8	n.c.
ADDR (dummy plug)	connection for ASi addressing device						
BWU2983	X1	I1	24 V _{out of ASi}	n.c.	0 V _{out of ASi}	I1	n.c.
	X2	I2	24 V _{out of ASi}	n.c.	0 V _{out of ASi}	I2	n.c.
	X3	I3	24 V _{out of ASi}	n.c.	0 V _{out of ASi}	I3	n.c.
	X4	I4	24 V _{out of ASi}	n.c.	0 V _{out of ASi}	I4	n.c.
	X5	I5	24 V _{out of ASi}	n.c.	0 V _{out of ASi}	I5	n.c.
	X6	I6	24 V _{out of ASi}	n.c.	0 V _{out of ASi}	I6	n.c.
	X7	I7	24 V _{out of ASi}	n.c.	0 V _{out of ASi}	I7	n.c.
	X8	I8	24 V _{out of ASi}	n.c.	0 V _{out of ASi}	I8	n.c.
ADDR (dummy plug)	connection for ASi addressing device						
BWU2652	X1	O1	0 V _{ext out}	O2	0 V _{ext out}	O1	n.c.
	X2	O2	0 V _{ext out}	n.c.	0 V _{ext out}	O2	n.c.
	X3	O3	0 V _{ext out}	O4	0 V _{ext out}	O3	n.c.
	X4	O4	0 V _{ext out}	n.c.	0 V _{ext out}	O4	n.c.
	X5	O5	0 V _{ext out}	O6	0 V _{ext out}	O5	n.c.
	X6	O6	0 V _{ext out}	n.c.	0 V _{ext out}	O6	n.c.
	X7	O7	0 V _{ext out}	O8	0 V _{ext out}	O7	n.c.
	X8	O8	0 V _{ext out}	n.c.	0 V _{ext out}	O8	n.c.
ADDR (dummy plug)	connection for ASi addressing device						
BWU2770	X1	I1	24 V _{ext out}	I2	0 V _{ext out}	I1	n.c.
	X2	I2	24 V _{ext out}	n.c.	0 V _{ext out}	I2	n.c.
	X3	I3	24 V _{ext out}	I4	0 V _{ext out}	I3	n.c.
	X4	I4	24 V _{ext out}	n.c.	0 V _{ext out}	I4	n.c.
	X5	I5	24 V _{ext out}	I6	0 V _{ext out}	I5	n.c.
	X6	I6	24 V _{ext out}	n.c.	0 V _{ext out}	I6	n.c.
	X7	I7	24 V _{ext out}	I8	0 V _{ext out}	I7	n.c.
	X8	I8	24 V _{ext out}	n.c.	0 V _{ext out}	I8	n.c.
ADDR (dummy plug)	connection for ASi addressing device						

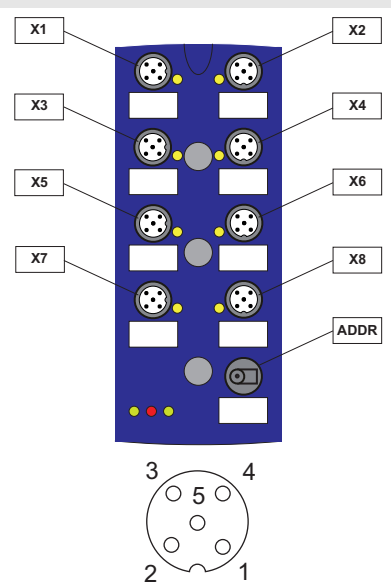

Digital Modules ASi, IP67, M12



Connections							
Article no.	M12 connection	Marking	Pin1	Pin2	Pin3	Pin4	Pin5
BWU2810	X1	I1	24 V _{ext out}	n.c.	0 V _{ext out}	I1	n.c.
	X2	I2	24 V _{ext out}	n.c.	0 V _{ext out}	I2	n.c.
	X3	I3	24 V _{ext out}	n.c.	0 V _{ext out}	I3	n.c.
	X4	I4	24 V _{ext out}	n.c.	0 V _{ext out}	I4	n.c.
	X5	O1	0 V _{ext out}	n.c.	0 V _{ext out}	O1	n.c.
	X6	O2	0 V _{ext out}	n.c.	0 V _{ext out}	O2	n.c.
	X7	O3	0 V _{ext out}	n.c.	0 V _{ext out}	O3	n.c.
	X8	O4	0 V _{ext out}	n.c.	0 V _{ext out}	O4	n.c.
	ADDR (dummy plug)	connection for ASi addressing device					
BWU3510	X1	I1	24 V _{ext out}	I2	0 V _{ext out}	I1	n.c.
	X2	I2	24 V _{ext out}	n.c.	0 V _{ext out}	I2	n.c.
	X3	I3	24 V _{ext out}	I4	0 V _{ext out}	I3	n.c.
	X4	I4	24 V _{ext out}	n.c.	0 V _{ext out}	I4	n.c.
	X5	O1	n.c.	O2	0 V _{ext out}	O1	n.c.
	X6	O2	n.c.	n.c.	0 V _{ext out}	O2	n.c.
	X7	O3	n.c.	O4	0 V _{ext out}	O3	n.c.
	X8	O4	n.c.	n.c.	0 V _{ext out}	O4	n.c.
	ADDR (dummy plug)	connection for ASi addressing device					

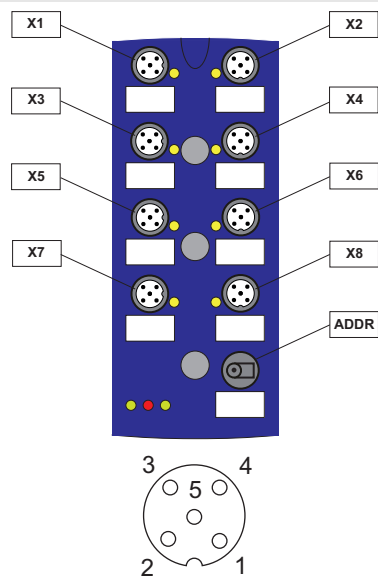

Digital Modules ASi, IP67, M12



Connections							
Article no.	M12 connection	Marking	Pin1	Pin2	Pin3	Pin4	Pin5
BWU2645	X1	I1	24 V _{ext out}	n.c.	0 V _{ext out}	I1	n.c.
	X2	I2	24 V _{ext out}	n.c.	0 V _{ext out}	I2	n.c.
	X3	I3	24 V _{ext out}	n.c.	0 V _{ext out}	I3	n.c.
	X4	I4	24 V _{ext out}	n.c.	0 V _{ext out}	I4	n.c.
	X5	O1	0 V _{ext out}	n.c.	0 V _{ext out}	O1	n.c.
	X6	O2	0 V _{ext out}	n.c.	0 V _{ext out}	O2	n.c.
	X7	O3	0 V _{ext out}	n.c.	0 V _{ext out}	O3	n.c.
	X8	O4	0 V _{ext out}	n.c.	0 V _{ext out}	O4	n.c.
	X9	ASi	ASi+	0 V _{ext in}	ASi-	24 V _{ext in}	-

Mounting according to cable direction

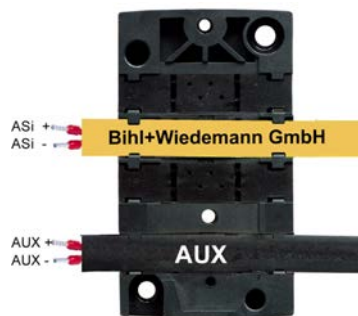

ordinary

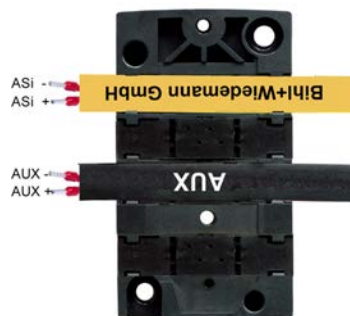

turned

Line termination with sealing profiles / as junction

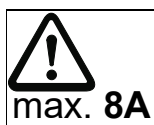
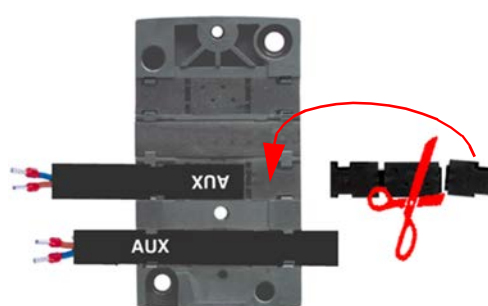
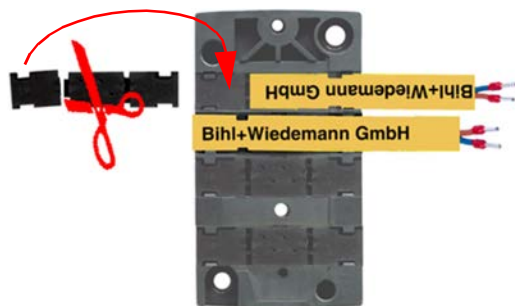

Accessories:

- ASi substructure module for 4 channel module in 45 mm housing (art. no. BWU2349)
- ASi substructure module (CNOMO) for 4 channel module in 45 mm housing (art. no. BWU2350)
- ASi substructure module (CNOMO) for 8 channel module in 60 mm housing (art. no. BWU2351)
- Protection caps for unused M12 sockets (art. no. BW2368)
- Sealing profile IP67 (IDC plug), 60 mm (art. no. BW3282)
- Sealing profile IP67 (IDC plug), 45 mm (art. no. BW3283)
- Passive Distributor ASi/AUX to 2 x M12 socket, internal protection via changeable 4 A slow-blow fuses (art. no. BWU3087)
- It is recommended to use pre-assembled cables to connect the power source with the module.



SCATTERGOOD & JOHNSON LTD

ELECTRICAL ENGINEERING & FLUID CONTROL DISTRIBUTORS

Est.1899

At Scattergood & Johnson Ltd, we pride ourselves on being a technical distributor to specialist industries.

Working with a range of quality product suppliers across a number of specialist markets, we are not your average 'box shifter' - we are your technical and supply chain partner.

We fully support every product we sell - for free! Our internal team and external sales engineers can answer any product or application question, no matter the complexity.

Backing up this technical ability is a range of 50,000+ products available from stock for nationwide next day delivery (same day if required!), or you can collect what you need from any of our trade counters around the UK.

Select your specialist interest below to learn more about how we can help.

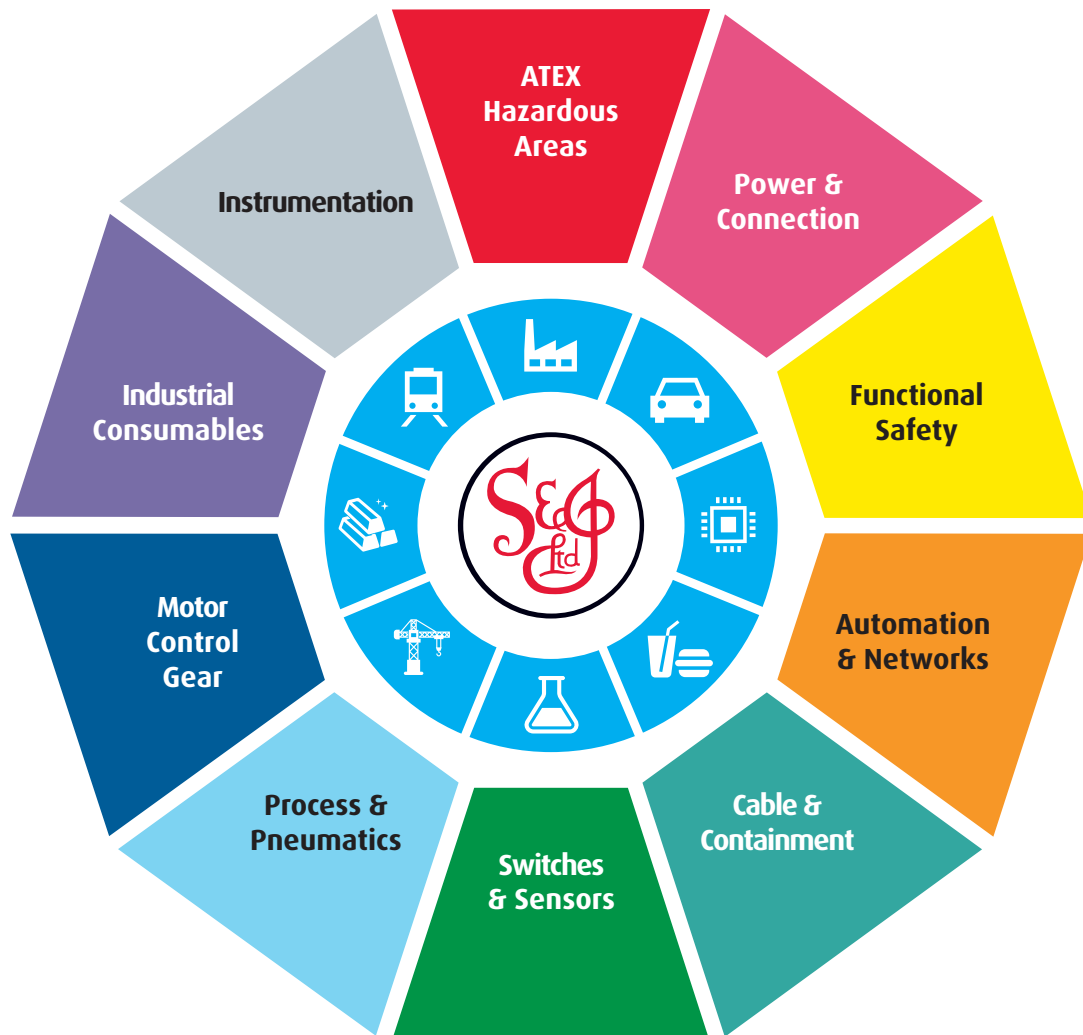

Online, In Branch and On the Road - Scattergood & Johnson Ltd, there when you need us.

www.scatts.co.uk