



# DL100-22AA2103

Dx100

LONG RANGE DISTANCE SENSORS

**SICK**  
Sensor Intelligence.



Illustration may differ



## Ordering information

Type	Part no.
DL100-22AA2103	1052694

Other models and accessories → [www.sick.com/Dx100](http://www.sick.com/Dx100)

## Detailed technical data

### Mechanics/electronics

<b>Supply voltage <math>V_s</math></b>	DC 18 V ... 30 V, limit values
<b>Ripple</b>	5 V <sub>pp</sub> <sup>1)</sup>
<b>Initialization time</b>	Typ. 1.5 s <sup>2)</sup>
<b>Housing material</b>	Metal (Aluminum die cast)
<b>Window material</b>	Plastic (PMMA)
<b>Connection type</b>	Male connector, M12, SPEEDCON™ compatible
<b>Indication</b>	6 digit 5 x 7 dot matrix display, LEDs
<b>Weight</b>	Approx. 800 g (with mounting bracket: approx. 1,600 g)
<b>Current consumption</b>	At 24 V DC < 250 mA
<b>Dimensions (W x H x D)</b>	69.4 mm x 82.5 mm x 100.2 mm
<b>Modulation frequency</b>	Fix
<b>Enclosure rating</b>	IP65
<b>Protection class</b>	III

<sup>1)</sup> May not fall short of or exceed  $V_s$  tolerances.

<sup>2)</sup> After loss of reflector < 40 ms.

### Performance

<b>Measuring range</b>	0.15 m ... 200 m, on reflective tape "Diamond Grade"
<b>Target</b>	Reflector
<b>Resolution</b>	0.1 mm, 0.125 mm, 1 mm, 10 mm, 100 mm
<b>Repeatability</b>	1 mm <sup>1)</sup>
<b>Accuracy</b>	± 2.5 mm <sup>2)</sup>
<b>Response time</b>	2 ms
<b>Measurement cycle time</b>	1 ms
<b>Output time</b>	1 ms

<sup>1)</sup> Statistical error 1  $\sigma$ , environmental conditions constant, min. warm-up time 10 min.

<sup>2)</sup> From 150 mm ... 180 mm measuring range the accuracy can reach ± 4 mm.

<sup>3)</sup> Average service life: 100,000 h at  $T_U = +25$  °C.

<b>Light source</b>	Laser, red <sup>3)</sup> visible red light
<b>Laser class</b>	2, complies with 21 CFR 1040.10 and 1040.11 except for the conformance according to "Laser Notice No. 50" from June 24, 2007 (IEC 60825-1:2014, EN 60825-1:2014)
<b>Typ. light spot size (distance)</b>	5 mm + (2 mm x distance in m)
<b>Max. movement speed</b>	15 m/s
<b>Acceleration (max.)</b>	≤ 15 m/s <sup>2</sup>

<sup>1)</sup> Statistical error 1 σ, environmental conditions constant, min. warm-up time 10 min.

<sup>2)</sup> From 150 mm ... 180 mm measuring range the accuracy can reach ± 4 mm.

<sup>3)</sup> Average service life: 100,000 h at T<sub>U</sub> = +25 °C.

## Interfaces

<b>Serial</b>	✓, RS-422
<b>Digital output</b>	
Number	2 <sup>1)</sup>
Type	Push-pull: PNP/NPN
Function	Distance: Distance switching output; Speed; Speed output; Service: Warning message as the sensor ages, if the damping value is exceeded (for example when contaminated, if the permitted interior device temperature is exceeded or undercut, if the measured value has a plausibility error, if the laser is not ready for operation, if the heating is switched on; Laser off; Preset
Maximum output current I <sub>A</sub>	≤ 100 mA <sup>2)</sup>
<b>Multifunctional input (MF)</b>	1 x MF1 <sup>3)</sup>

<sup>1)</sup> HIGH = > V<sub>S</sub> - 3 V / LOW = < 2 V.

<sup>2)</sup> Max. 100 nF/20 mH.

<sup>3)</sup> HIGH > 12 V / LOW < 3 V.

## Ambient data

<b>Electromagnetic compatibility (EMC)</b>	EN 61000-6-2, EN 61000-6-4 <sup>1)</sup>
<b>Ambient temperature operation</b>	-20 °C ... +55 °C <sup>2)</sup> -20 °C ... +75 °C, operation with cooling case <sup>2)</sup>
<b>Ambient storage temperature</b>	-40 °C ... +75 °C
<b>Effect of air pressure</b>	0.3 ppm/hPa
<b>Effect of air temperature</b>	1 ppm/K
<b>Temperature drift</b>	Typ. 0.1 mm/K
<b>Typ. Ambient light immunity</b>	≤ 100,000 lx
<b>Mechanical load</b>	Shock: (EN 600 68-2-27) Sine: (EN 600 68-2-6) Noise: (EN 600 68-2-64)

<sup>1)</sup> This is a Class A device. This device can cause radio interference in living quarters.

<sup>2)</sup> Temperatures < -10 °C require warm-up time of typ. 7 minutes.

## Classifications

<b>ECl@ss 5.0</b>	27270801
<b>ECl@ss 5.1.4</b>	27270801
<b>ECl@ss 6.0</b>	27270801
<b>ECl@ss 6.2</b>	27270801
<b>ECl@ss 7.0</b>	27270801

<b>ECl@ss 8.0</b>	27270801
<b>ECl@ss 8.1</b>	27270801
<b>ECl@ss 9.0</b>	27270801
<b>ECl@ss 10.0</b>	27270801
<b>ECl@ss 11.0</b>	27270801
<b>ETIM 5.0</b>	EC001825
<b>ETIM 6.0</b>	EC001825
<b>ETIM 7.0</b>	EC001825
<b>UNSPSC 16.0901</b>	41111613

**Dimensional drawing** (Dimensions in mm (inch))

Dimensional drawing

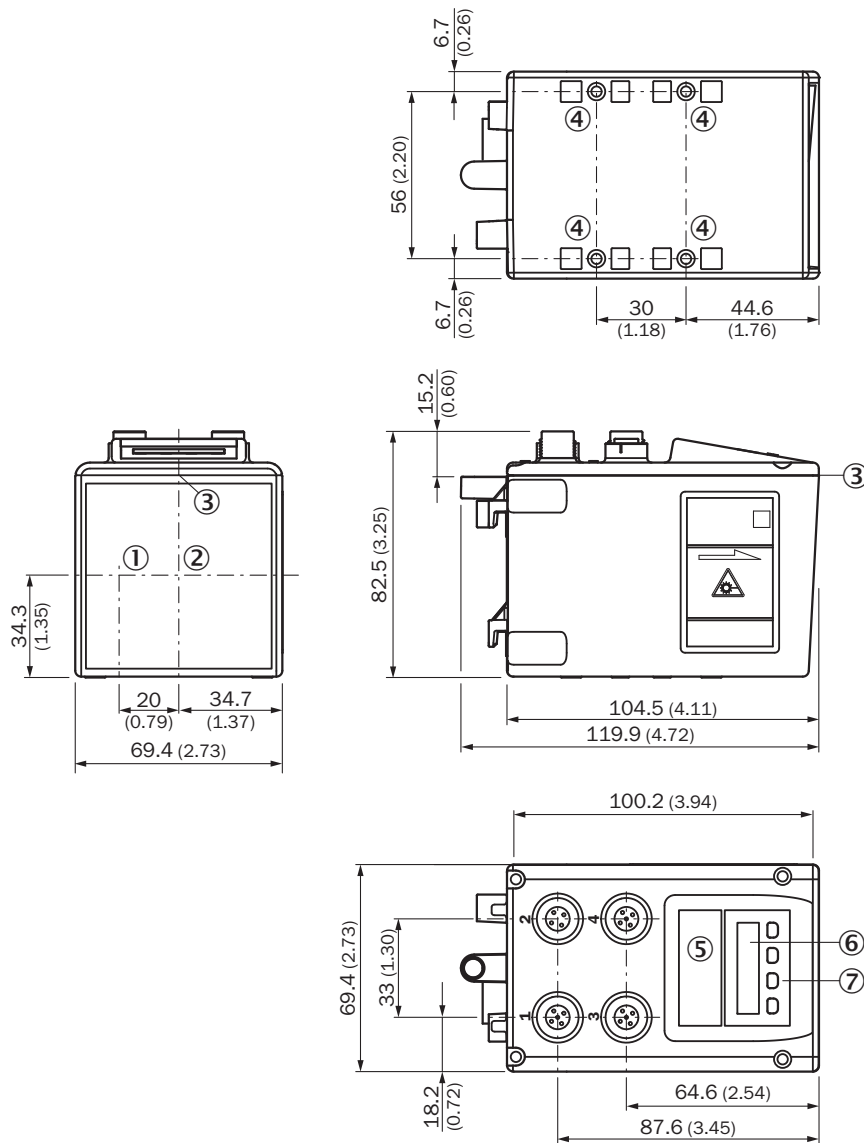

- ① Optical axis, sender
- ② Optical axis, receiver
- ③ Zero level
- ④ Threaded mounting hole M5
- ⑤ Status LED [status]
- ⑥ Display
- ⑦ Control elements

**Connection type**

Ethernet connection type



SSI/RS-422 connection type

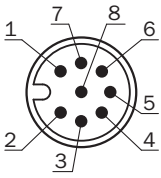

**Connection diagram**

SSI/RS-422 connection diagram

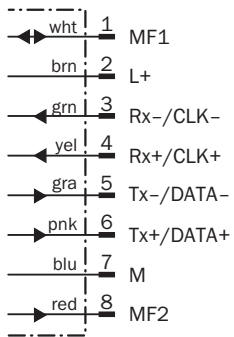

Ethernet connection diagram

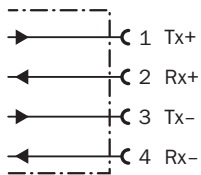

**Adjustment possible**



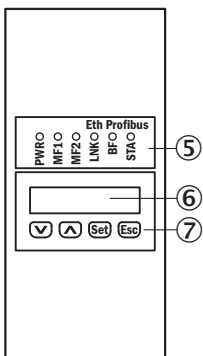



DL100-xxXXxx02



- ⑤ Status LED [status]
- ⑥ Display
- ⑦ Control elements

## Recommended accessories

Other models and accessories → [www.sick.com/Dx100](http://www.sick.com/Dx100)

	Brief description	Type	Part no.
<b>Terminal and alignment brackets</b>			
	Alignment unit for Dx100, incl. mounting material, steel, zinc coated	BEF-AH-DX100	2058653
<b>Reflectors</b>			
	Reflector plate, "diamond grade" reflective tape, 330 mm x 330 mm, base plate material: aluminum, screw connection, Screw-on, 4 hole mounting	PL240DG	1017910
	Reflector plate, "diamond grade" reflective tape, 665 mm x 665 mm, base plate material: aluminum, screw connection, Screw-on, 4 hole mounting	PL560DG	1016806
<b>Sets and kits</b>			
	Accessory kit for upgrade from DME3000 SSI/RS-422 to Dx100 SSI/RS-422	DME3000 Dx100 SSI/RS-422 upgrade kit	2065223
	Accessory kit for upgrade from DME4000/5000 SSI/RS-422 to Dx100 SSI/RS-422	DME4000/5000 Dx100 SSI/RS-422 upgrade kit	2065221
<b>Plug connectors and cables</b>			
	Head A: female connector, M12, 8-pin, straight Head B: Flying leads Cable: PUR, halogen-free, shielded, 5 m	YF2A68-050XXXXLEAX	6032449
	Head A: male connector, M12, 4-pin, straight, D-coded Head B: male connector, RJ45, 8-pin, straight Cable: PROFINET, PUR, halogen-free, shielded, 5 m	SSL-2J04-G05MZ	6035389

## Recommended services

Additional services → [www.sick.com/Dx100](http://www.sick.com/Dx100)

	Type	Part no.
<b>Warranty extensions</b>		
<ul style="list-style-type: none"> <li>• <b>Product area:</b> Identification solutions, machine vision, Distance sensors, Detection and ranging solutions</li> <li>• <b>Range of services:</b> The services correspond to the scope of the statutory manufacturer warranty (SICK general terms and conditions of purchase)</li> <li>• <b>Duration:</b> Five-year warranty from delivery date.</li> </ul>	Extended warranty for a total of five years from delivery date	1680671

## SICK AT A GLANCE

SICK is one of the leading manufacturers of intelligent sensors and sensor solutions for industrial applications. A unique range of products and services creates the perfect basis for controlling processes securely and efficiently, protecting individuals from accidents and preventing damage to the environment.

We have extensive experience in a wide range of industries and understand their processes and requirements. With intelligent sensors, we can deliver exactly what our customers need. In application centers in Europe, Asia and North America, system solutions are tested and optimized in accordance with customer specifications. All this makes us a reliable supplier and development partner.

Comprehensive services complete our offering: SICK LifeTime Services provide support throughout the machine life cycle and ensure safety and productivity.

For us, that is “Sensor Intelligence.”

## WORLDWIDE PRESENCE:

Contacts and other locations –[www.sick.com](http://www.sick.com)