



# S30A-7011CA

S3000 Advanced

SAFETY LASER SCANNERS

**SICK**  
Sensor Intelligence.



### Ordering information

Type	Part no.
S30A-7011CA	1023891

The system plug has to be ordered separately. For details, see "Accessories".

Other models and accessories → [www.sick.com/S3000\\_Advanced](http://www.sick.com/S3000_Advanced)

system plug not supplied with delivery

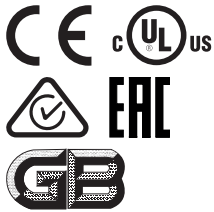

### Detailed technical data

#### Features

<b>Protective field range</b>	7 m
<b>Warning field range</b>	49 m (20 m at 20 % reflectivity)
<b>Distance measuring range</b>	49 m
<b>Number of simultaneously monitored protective fields</b>	≤ 4 <sup>1)</sup>
<b>Type of field set</b>	Triple field sets, dual field sets
<b>Number of field sets</b>	4
<b>Number of fields</b>	12
<b>Number of monitoring cases</b>	4
<b>Scanning angle</b>	190°
<b>Resolution (can be configured)</b>	30 mm, 40 mm, 50 mm, 70 mm, 150 mm
<b>Angular resolution</b>	0.5°, 0.25°, depending on range and resolution
<b>Response time</b>	60 ms <sup>2)</sup>
<b>Protective field supplement</b>	100 mm
<b>Number of multiple samplings</b>	2 ... 16, configurable
<b>Delay of automatic reset</b>	2 s ... 60 s, configurable

<sup>1)</sup> If several protective fields are monitored simultaneously, the shut-off signals must be connected to safe outputs on a Flexi Soft safety controller or routed via a safe EFI gateway.

<sup>2)</sup> Depending on basic response time and multiple sampling.

#### Safety-related parameters

<b>Type</b>	Type 3 (IEC 61496)
<b>Safety integrity level</b>	SIL2 (IEC 61508) SILCL2 (EN 62061)

<b>Category</b>	Category 3 (EN ISO 13849)
<b>Performance level</b>	PL d (EN ISO 13849)
<b>PFH<sub>D</sub> (mean probability of a dangerous failure per hour)</b>	$8.0 \times 10^{-8}$ (EN ISO 13849)
<b>T<sub>M</sub> (mission time)</b>	20 years (EN ISO 13849)
<b>Safe state in the event of a fault</b>	At least one OSSD is in the OFF state.

### Functions

<b>Restart interlock</b>	✓
<b>External device monitoring (EDM)</b>	✓
<b>Multiple sampling</b>	✓
<b>Monitoring case switching</b>	✓
<b>Simultaneous monitoring</b>	✓
<b>Static protective field switching</b>	✓
<b>Contour as a reference</b>	✓
<b>Integrated configuration memory</b>	✓
<b>Measured data output</b>	Via RS-422
<b>Safe SICK device communication via EFI</b>	✓

### Electrical data

<b>Protection class</b>	II (EN 50178)
<b>Supply voltage V<sub>s</sub></b>	24 V DC (16.8 V DC ... 28.8 V DC)
<b>Power consumption</b>	$\leq 0.8 \text{ A}^{1)}$ $\leq 2.3 \text{ A}^{2)}$
<b>Outputs</b>	
Output signal switching devices (OSSDs)	2 x 500 mA
Application diagnostic outputs	3 x 100 mA <sup>3)</sup>

<sup>1)</sup> At 24 V DC without output load.

<sup>2)</sup> At 24 V DC including maximum output load.

<sup>3)</sup> Freely programmable, e.g. warning field, contamination, reset required.

### Mechanical data

<b>Dimensions (W x H x D)</b>	155 mm x 185 mm x 160 mm
<b>Weight</b>	3.3 kg
<b>Housing material</b>	Aluminum die cast
<b>Housing color</b>	RAL 1021 (yellow)
<b>Front screen material</b>	Polycarbonate
<b>Front screen surface finish</b>	Outside with scratch-resistant coating

### Ambient data

<b>Enclosure rating</b>	IP65 (EN 60529)
<b>Ambient operating temperature</b>	-10 °C ... +50 °C
<b>Storage temperature</b>	-25 °C ... +50 °C
<b>Vibration resistance</b>	5 g, 10 Hz ... 150 Hz (IEC 61496, IEC 61496-3)
<b>Shock resistance</b>	

Continuous shock	10 g, 16 ms (IEC 61496, IEC 61496-3)
------------------	--------------------------------------

### Other information

<b>Type of light</b>	Pulsed laser diode
<b>Wave length</b>	905 nm
<b>Detectable remission</b>	1.8 % ... > 1,000 %, reflectors
<b>Laser class</b>	1 (21 CFR 1040.10 and 1040.11, IEC 60825-1)

### Classifications

<b>ECl@ss 5.0</b>	27272705
<b>ECl@ss 5.1.4</b>	27272705
<b>ECl@ss 6.0</b>	27272705
<b>ECl@ss 6.2</b>	27272705
<b>ECl@ss 7.0</b>	27272705
<b>ECl@ss 8.0</b>	27272705
<b>ECl@ss 8.1</b>	27272705
<b>ECl@ss 9.0</b>	27272705
<b>ECl@ss 10.0</b>	27272705
<b>ECl@ss 11.0</b>	27272705
<b>ETIM 5.0</b>	EC002550
<b>ETIM 6.0</b>	EC002550
<b>ETIM 7.0</b>	EC002550
<b>UNSPSC 16.0901</b>	39121528

**Dimensional drawing** (Dimensions in mm (inch))

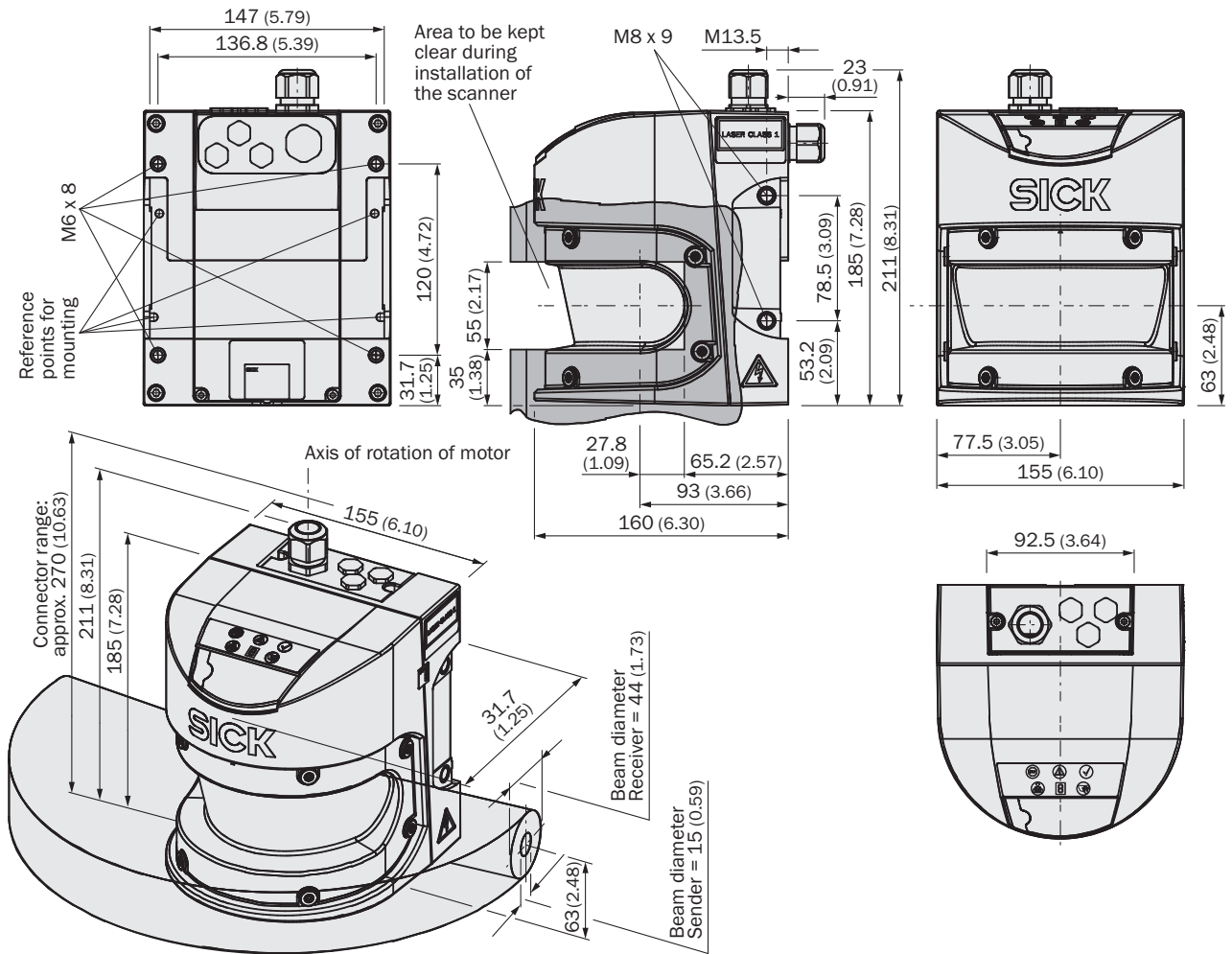

### Connection diagram

Protective field switching between two S3000 with static inputs

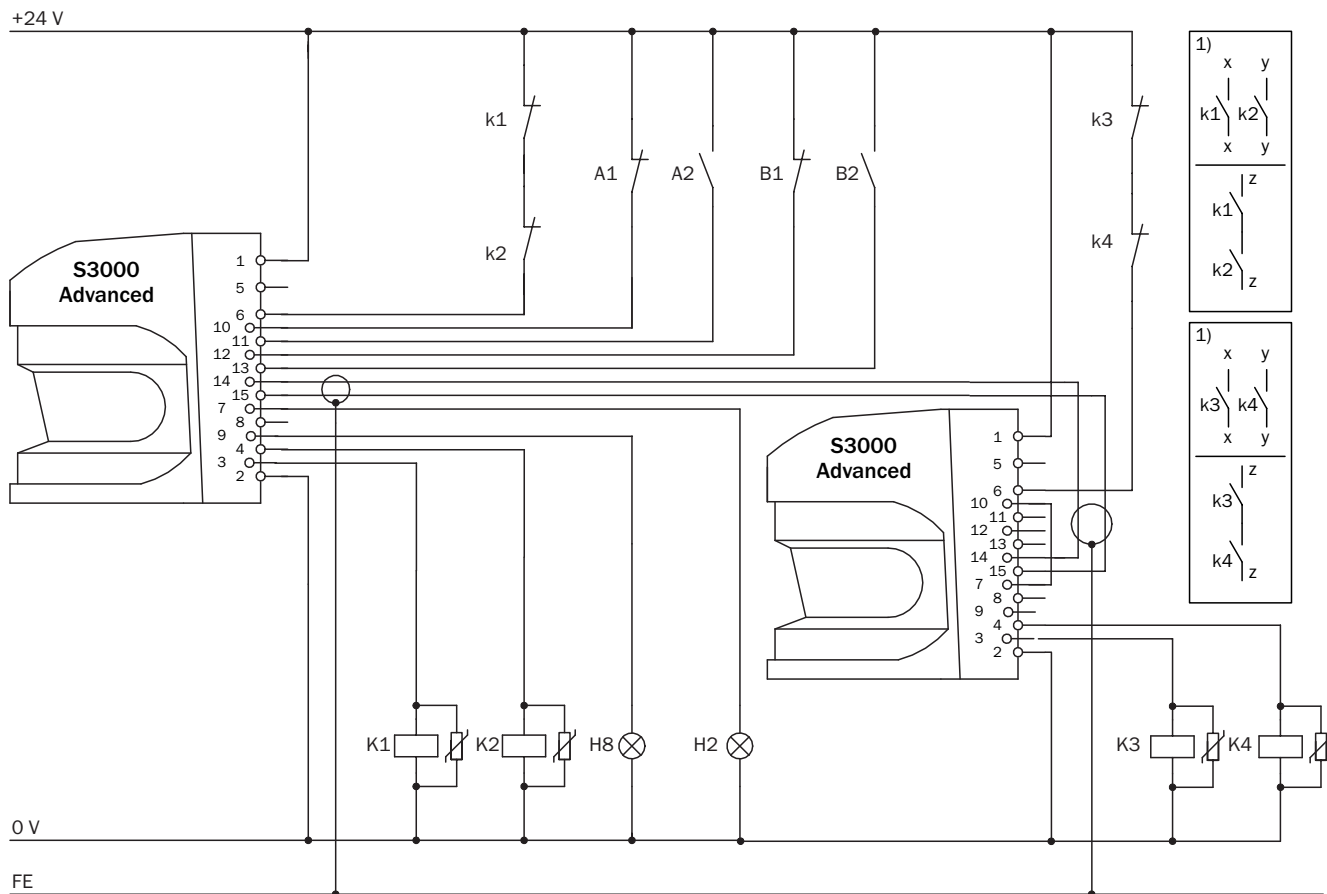

S3000 Advanced with S3000 Advanced in conjunction with relays/contactors

Operating mode: without restart interlock, with external device monitoring (EDM)

Protective field switching by means of control input A and control input B on separate OSSD pairs (simultaneous monitoring)

#### Comments

<sup>1)</sup> Output circuits: These contacts are to be connected to the controller such that, with the output circuit open, the dangerous state is disabled. For categories 4 and 3, this integration must be dual-channel (x/y paths). Single-channel insertion in the control (z path) is only possible with a single-channel control and by taking the risk analysis into account.

Protective field switching with two static inputs

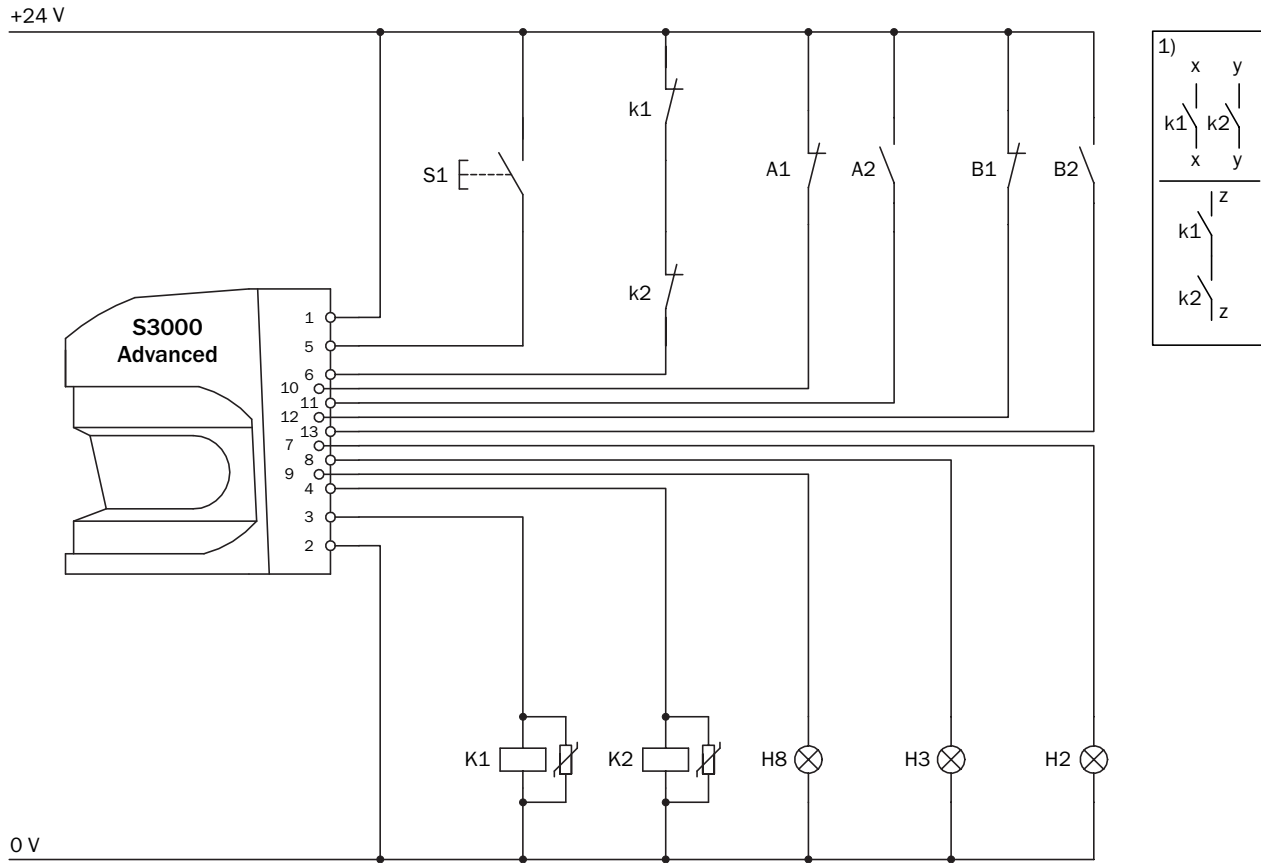

E112707/00/2014-03-06



S3000 Advanced in conjunction with relays/contactors  
Operating mode: with restart interlock and external device monitoring (EDM)  
Protective field switching by means of control inputs A and B











**Comments**

<sup>1)</sup> Output circuits: These contacts are to be connected to the controller such that, with the output circuit open, the dangerous state is disabled. For categories 4 and 3, this integration must be dual-channel (x/y paths). Single-channel insertion in the control (z path) is only possible with a single-channel control and by taking the risk analysis into account.

**Recommended accessories**

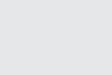
Other models and accessories → [www.sick.com/S3000\\_Advanced](http://www.sick.com/S3000_Advanced)

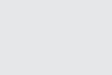
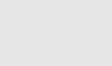
	Brief description	Type	Part no.
<b>Mounting brackets and plates</b>			
	1 piece, Visor for heavy duty mounting kit (2080350), steel, painted (RAL 1021)	Heavy duty sight	2083733
	1 piece, Mounting bracket, heavy-duty version, with protection cover, for floor mounting, adjustable longitudinal and lateral axes via alignment plate, height adjustment possible. Tilt angle ± 5°. Additional mounting brackets are not required., steel, painted (RAL 1021)	Heavy-duty mounting kit	2080350

	Brief description	Type	Part no.
	1 piece, mounting bracket for direct mounting, from the rear, on wall or machine, not adjustable, Aluminum	Mounting kit 1	2015623
	1 piece, mounting bracket for rear mounting on wall or machine, adjustable longitudinal and lateral axes, only in conjunction with mounting kit 1 (2015623), Aluminum	Mounting kit 2	2015624
	1 piece, mounting bracket for rear mounting on wall, floor, or machine, adjustable longitudinal and lateral axes, only in conjunction with mounting kit 1 (2015623) and 2 (2015624), Aluminum	Mounting kit 3	2015625
<b>Plug connectors and cables</b>			
	Head A: Flying leads Head B: Flying leads Cable: PVC, unshielded	Connecting cable	6025729
	Head A: Flying leads Head B: Flying leads Cable: PVC, shielded Fitting for EFI connections	Connecting cable	6025730
	Head A: male connector, M8, 4-pin, straight Head B: male connector, USB-A, straight Cable: PVC, unshielded, 2 m	EFI connecting cable	6029448
	Head A: male connector, M8, 4-pin, straight Head B: male connector, USB-A, straight Cable: PVC, unshielded, 10 m	DSL-8U04G02M025KM1	6034574
	Head A: system plug Cable: without cable Not for use of incremental encoders, integrated configuration storage	DSL-8U04G10M025KM1	6034575
	Head A: system plug Cable: pre-assembled, Not for use of incremental encoders, integrated configuration storage, PVC, unshielded, 5 m	SX0A-A0000B	2023797
	Head A: system plug Cable: pre-assembled, Not for use of incremental encoders, integrated configuration storage, PVC, unshielded, 10 m	SX0A-B1305B	2027172
	Head A: system plug Cable: pre-assembled, Not for use of incremental encoders, integrated configuration storage, PVC, unshielded, 20 m	SX0A-B1310B	2027173
	Head A: system plug Cable: pre-assembled, Not for use of incremental encoders, integrated configuration storage, PVC, unshielded, 20 m	SX0A-B1320B	2027815

## SICK AT A GLANCE

SICK is one of the leading manufacturers of intelligent sensors and sensor solutions for industrial applications. A unique range of products and services creates the perfect basis for controlling processes securely and efficiently, protecting individuals from accidents and preventing damage to the environment.

We have extensive experience in a wide range of industries and understand their processes and requirements. With intelligent sensors, we can deliver exactly what our customers need. In application centers in Europe, Asia and North America, system solutions are tested and optimized in accordance with customer specifications. All this makes us a reliable supplier and development partner.

Comprehensive services complete our offering: SICK LifeTime Services provide support throughout the machine life cycle and ensure safety and productivity.

For us, that is “Sensor Intelligence.”

## WORLDWIDE PRESENCE:

Contacts and other locations –[www.sick.com](http://www.sick.com)